

SECTION E-E
SCALE 2:1

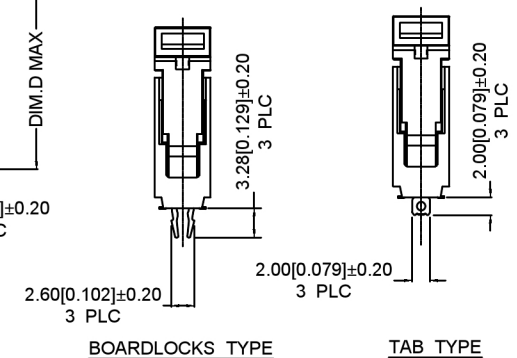
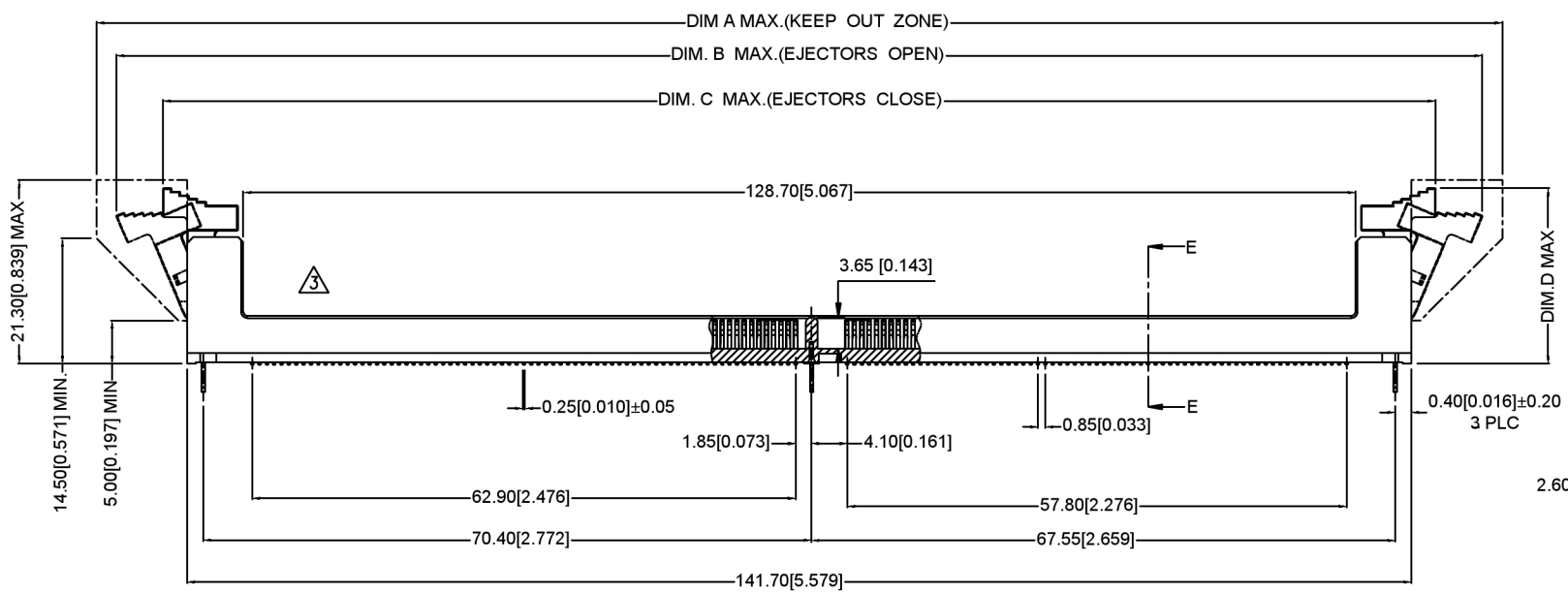

BOARDLOCKS TYPE

TAB TYPE

广东星坤科技股份有限公司

姓名	日期
数量	日期
MARK	DESCRIPTION
文件工程章	

MARK	DESCRIPTION	DATE	REVISED	APPROVED	UNSPECIFIED TOLERANCES
	REVISIONS				
					ANGLAR ±5°
					L ≤ 4 ±0.2
					4 < L ≤ 16 ±0.3
					16 < L ≤ 63 ±0.4
					L > 63 ±0.5



DSND	SCALE: N/A	MODEL TYPE:
DWN	VIEW:	PART NO.: X9414WVS-288XX-9TV15
CHKD	UNIT: mm/in	DWG NO.: X-X9414WVS-288XX-9TV15
APPD	SIZE: A4	WEIGHT SHEET REVISION
XKB INDUSTRIAL PRECISION CO., LIMITED		1/1 A0

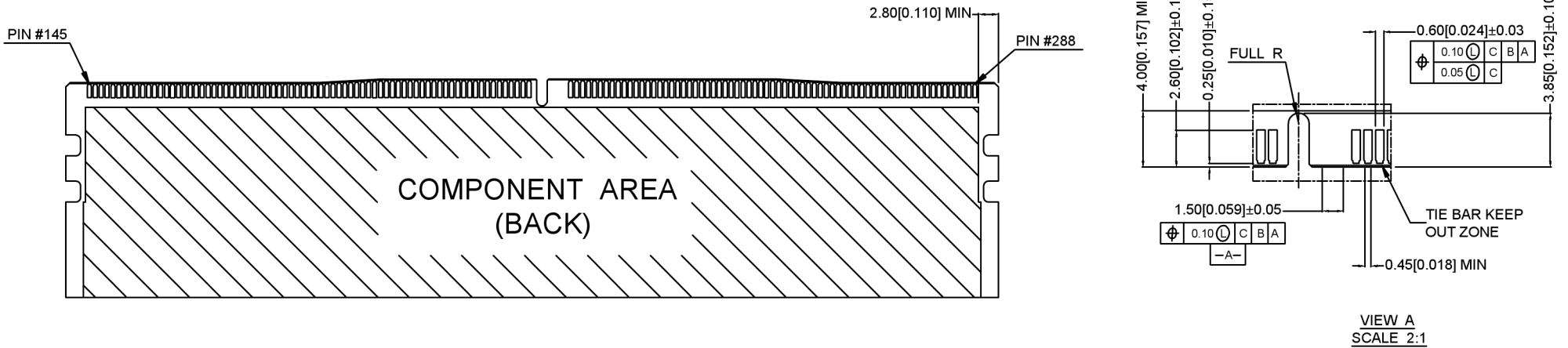
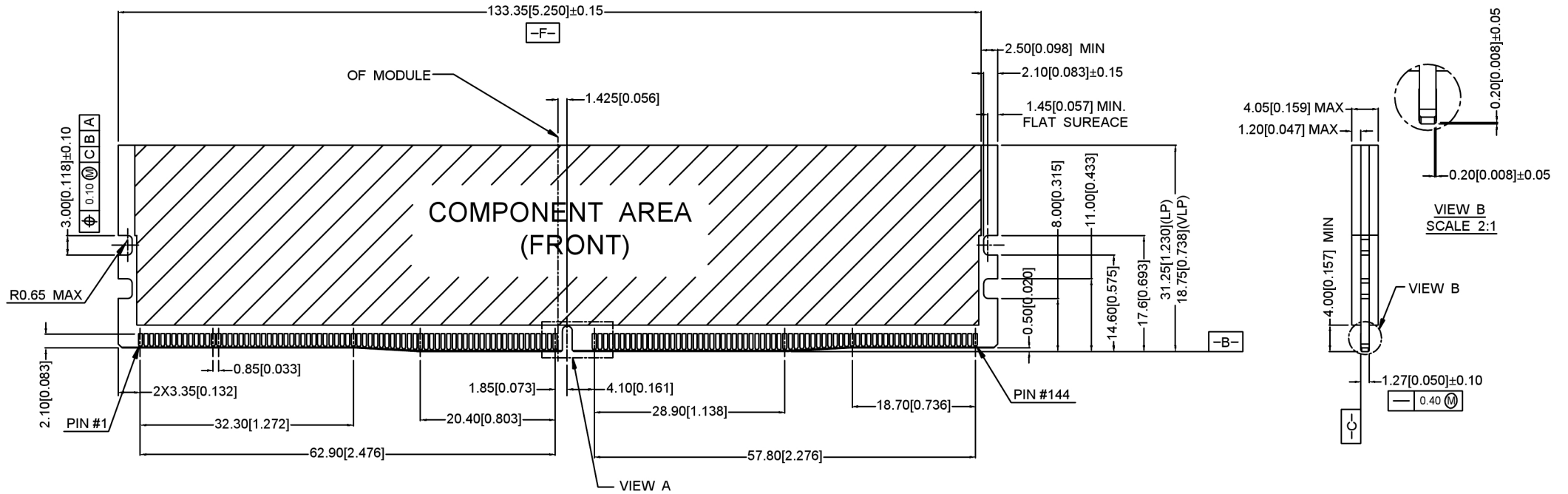

广东星坤科技股份有限公司

Δ定	日期
Δ改	日期
ΔX	

文件工程草

MARK	DESCRIPTION	DATE	REVISED	APPROVED	ANGLAR	±5°
	REVISIONS				L ≤ 4	±0.2
					4 < L ≤ 16	±0.3
					16 < L ≤ 63	±0.4
					L > 63	±0.5
					UNSPECIFIED TOLERANCES	



DSND	SCALE: N/A	MODEL TYPE:
DWN	VIEW:	PART NO.: X9414WVS-288XX-9TV15
CHKD	UNIT: mm/in	DWG NO.:
APPD	SIZE: A4	X-X9414WVS-288XX-9TV15
KXB INDUSTRIAL PRECISION CO., LIMITED		WEIGHT
		SHEET
		REVISION
		1/1
		A0

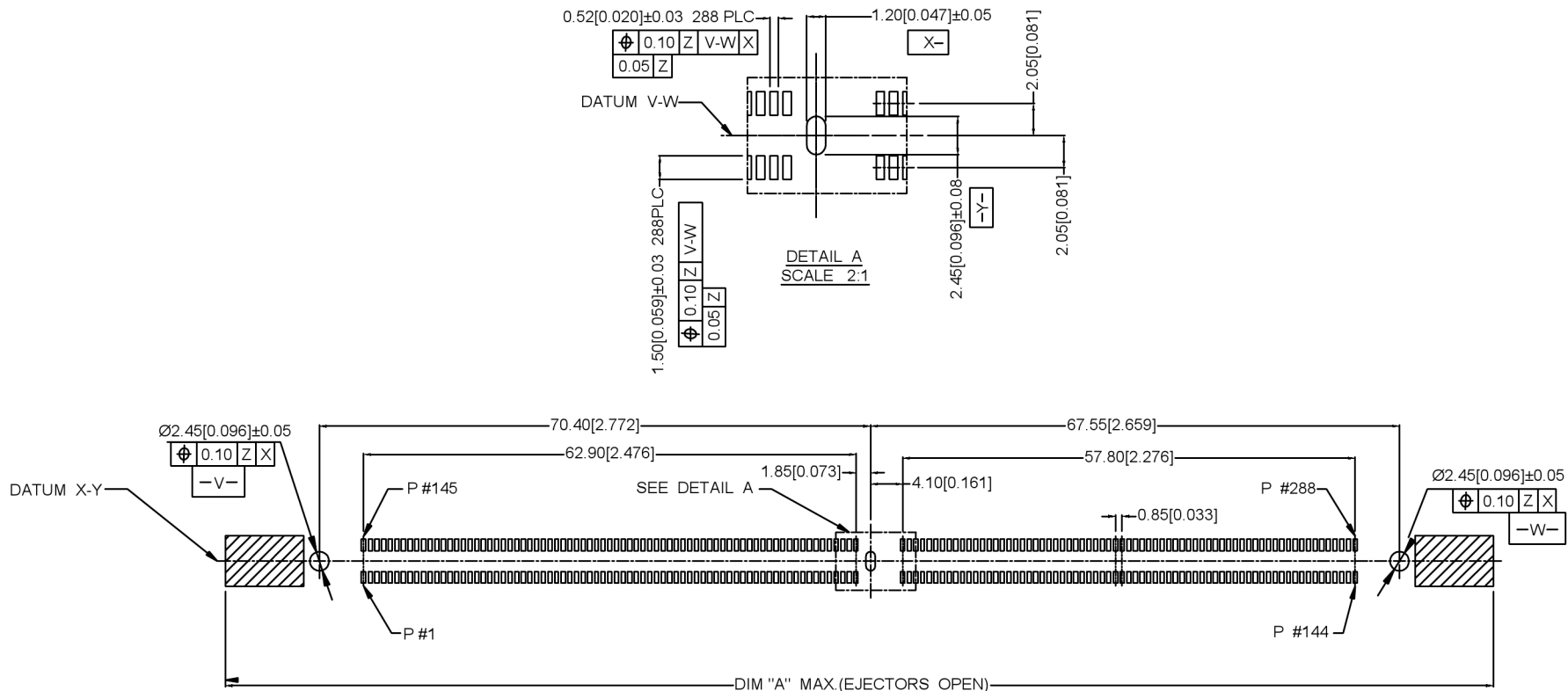

RECOMMENDED PCB LAYOUT (TOP VIEW)
FOR 3 BOARDLOCKS

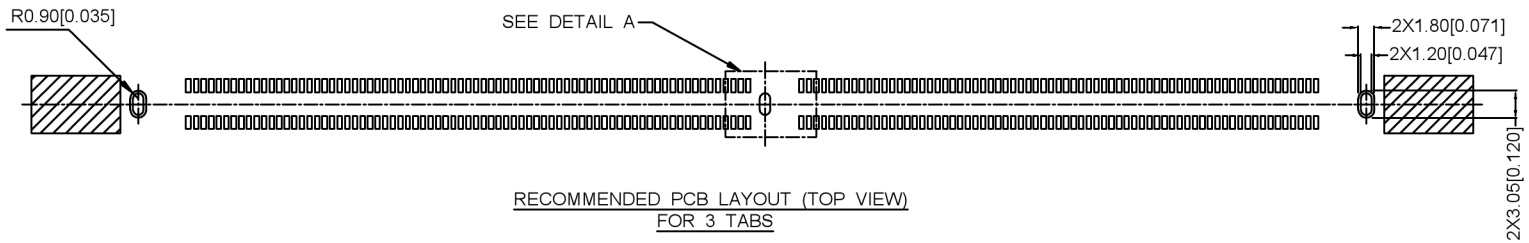

RECOMMENDED PCB LAYOUT (TOP VIEW)
FOR 3 TABS

-Z-

广东星坤科技股份有限公司

姓名	日期
数量	日期
MARK	DESCRIPTION

MARK	DESCRIPTION	DATE	REVISED	APPROVED	UNSPECIFIED TOLERANCES
	REVISIONS				



DSND	SCALE: N/A	MODEL TYPE:
DWN	VIEW:	PART NO.: X9414WVS-288XX-9TV15
CHKD	UNIT: mm/in	DWG NO.: X-X9414WVS-288XX-9TV15
APPD	SIZE: A4	WEIGHT SHEET REVISION
		1/1 A0

XKB INDUSTRIAL PRECISION CO., LIMITED

文件工程章

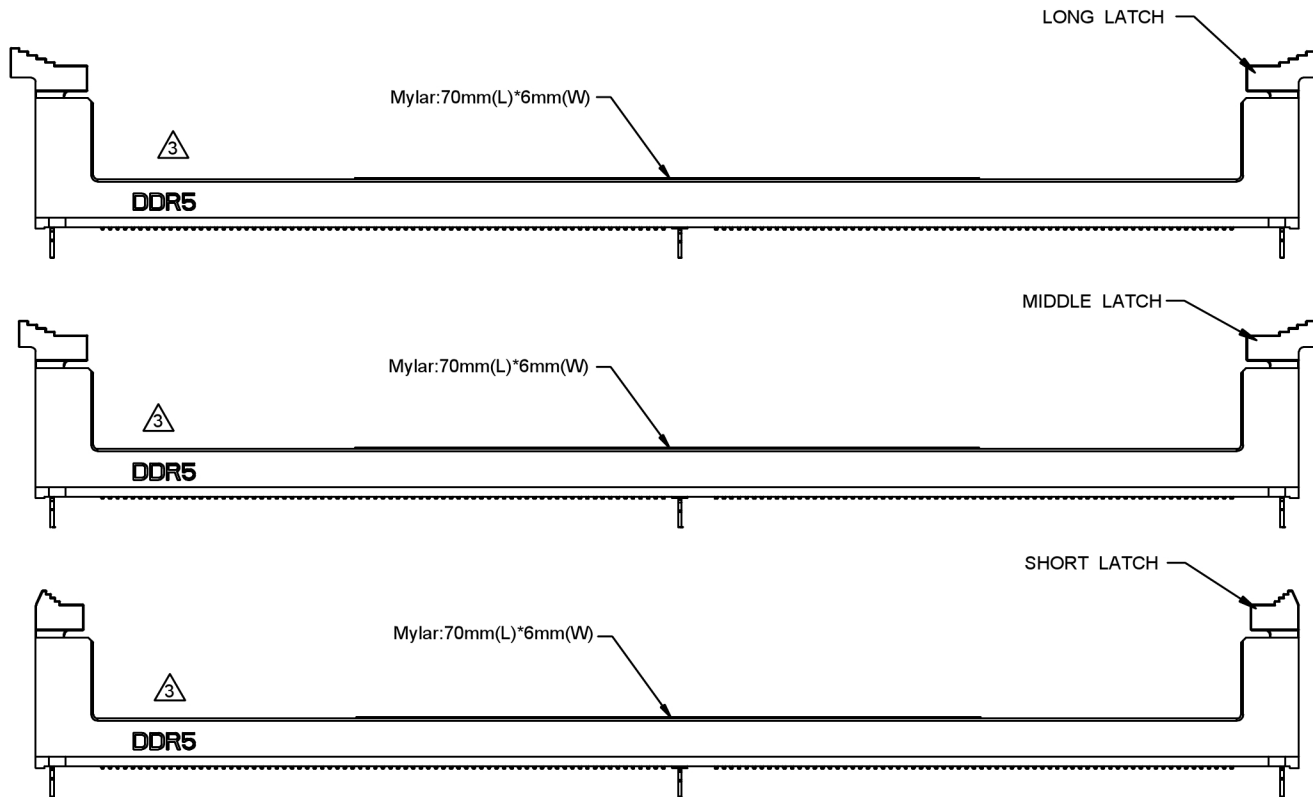

20.70	147.50	158.50	162.00	LONG
20.30	145.50	156.00	156.00	MIDDLE
20.20	142.00	151.50	152.00	SHORT
DIM.D	DIM.C	DIM.B	DIM.A	LATCH TYPE

X9414 W V S - 288 X X - 9T V15

- ① ② ③ ④ ⑤ ⑥ ⑦ ⑧ ⑨
- ① Series Number
 - ② Terminal form: WAFER
 - ③ Welding Board Angle : V-Stright Angle 180°
 - ④ Welding Way:S-SMT
 - ⑤ No.of Pins: 288PIN
 - ⑥ BOARDLOCK TYPE: B.BOARD LOCKS TYPE
T.TAB type
 - ⑦ LATCH TYPE: 1.short latch;2.long latch;3.middle latch
 - ⑧ Plastic material: PA9T
 - ⑨ Contact Plating:V15 Gold15"u"
V30 Gold 30"u"

NOTES 注释:

1. MATERIAL材料:
 - 1.1 HOUSING外壳: HIGH PERFROMANCE RESINS, GLASS FILBER,UL94V-0;COLOR:BLACK.
 - 1.2 LATCH锁: HIGH PERFROMANCE RESINS, GLASS FILBER, UL94 V-O;COLOR: BLACK.
 - 1.3 CONTACTS触点: COPPER ALLOY.
 - 1.4 BOARDLOCK针脚: STAINLESS STEEL.
 - 1.5 TABS标签: STAINLESS STEEL.
2. FINISH饰面:
 - 2.1 CONTACT触点:
[SEE PART NO..] GOLD PLATING ON THE CONTACT AREA.
2.54um [100u"] MIN. MATTE-TIN PLATING ON THE SOLDERING AREA
1.27um [50u"] MIN. NICKEL UNDERPLATING OVERALL.

广东星坤科技股份有限公司

DATE	日期
REVISION	REVISED

文件工程章

DESCRIPTION	DATE	REVISED	APPROVED	UNSPECIFIED TOLERANCES
REVISIONS				
www.helloxkb.com	www.helloxkb.cn	www.xk-dg.cn		

DSND	SCALE: N/A	MODEL TYPE:
DWN	VIEW:	PART NO.: X9414WVS-288XX-9TV15
CHKD	UNIT: mm/in	DWG NO.: X-X9414WVS-288XX-9TV15
APPD	SIZE: A4	WEIGHT
XKB INDUSTRIAL PRECISION CO.,LIMITED		SHEET
		REVISION
		1/1
		A0