

| | | | | | | | |
|---|-------------|------|---------|----------|--|------------------------|------|
| | | | | | | ANGLAR | ±5° |
| Δx | | | | | | L ≤ 4 | ±0.2 |
| Δx | | | | | | 4 < L ≤ 16 | ±0.3 |
| Δx | | | | | | 16 < L ≤ 63 | ±0.4 |
| MARK | DESCRIPTION | DATE | REVISED | APPROVED | | L > 63 | ±0.5 |
| REVISIONS | | | | | | UNSPECIFIED TOLERANCES | |
| www.helloxkb.com www.helloxkb.cn www.xk-dg.cn | | | | | | | |

| | | | |
|------|--|-------------|-----------------------|
| DSND | | SCALE: N/A | MODEL TYPE: |
| DWN | | VIEW: | PART NO.: |
| CHKD | | UNIT: mm/in | X1302WVS-67XX-LPVC |
| APPD | | SIZE: A4 | DWG NO.: |
| | | | X-X1302WVS-67XX-LPV01 |
| | | WEIGHT | SHEET |
| | | | REVISIC |
| | | | 1/1 |
| | | | A0 |

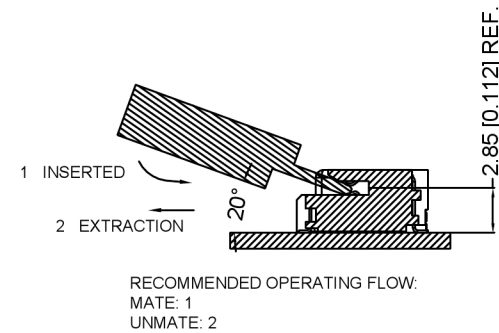

XKB INDUSTRIAL PRECISION CO., LIMITED

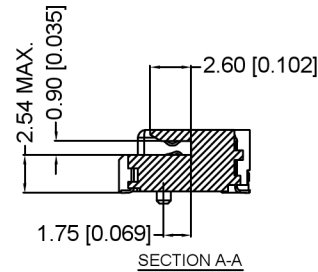
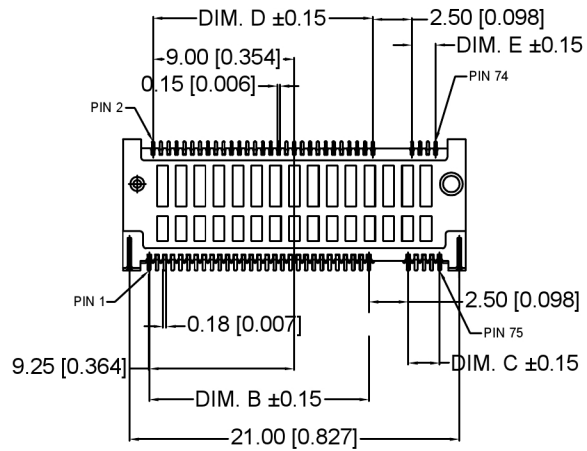
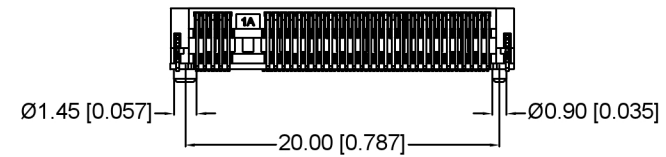
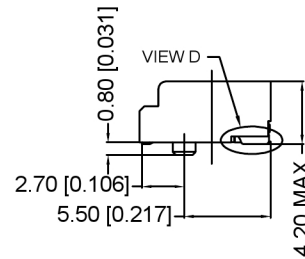
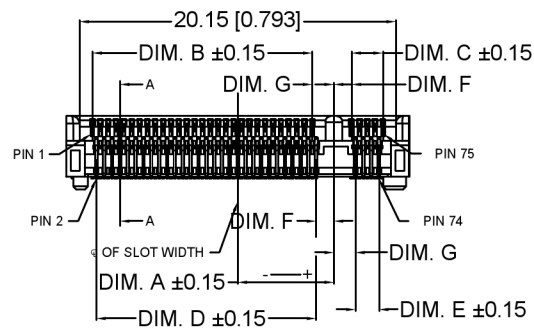
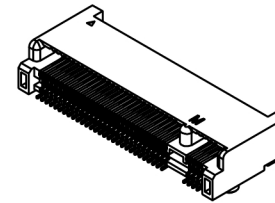
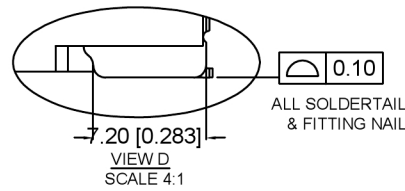
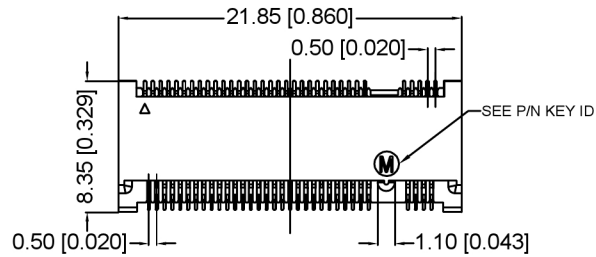

广东星坤科技股份有限公司
 生效日期
 文件工程章

| NO. | DESCRIPTION | DATE | REVISED | APPROVED | UNSPECIFIED TOLERANCES |
|-----|-------------|------|---------|----------|------------------------|
| 1 | ANGULAR | | | | ±5° |
| 2 | L ≤ 4 | | | | ±0.2 |
| 3 | 4 < L ≤ 16 | | | | ±0.3 |
| 4 | 16 < L ≤ 63 | | | | ±0.4 |
| 5 | L > 63 | | | | ±0.5 |

| | | |
|---------------------------------------|-------------|---------------------------------|
| DSND | SCALE: N/A | MODEL TYPE: |
| DWN | VIEW: | PART NO.: X1302WVS-67XX-LPV01 |
| CHKD | UNIT: mm/in | DWG NO.: |
| APPD | SIZE: A4 | X-X1302WVS-67XX-LPV01 |
| KXB INDUSTRIAL PRECISION CO., LIMITED | | WEIGHT SHEET REVISION 1/1 A0 |

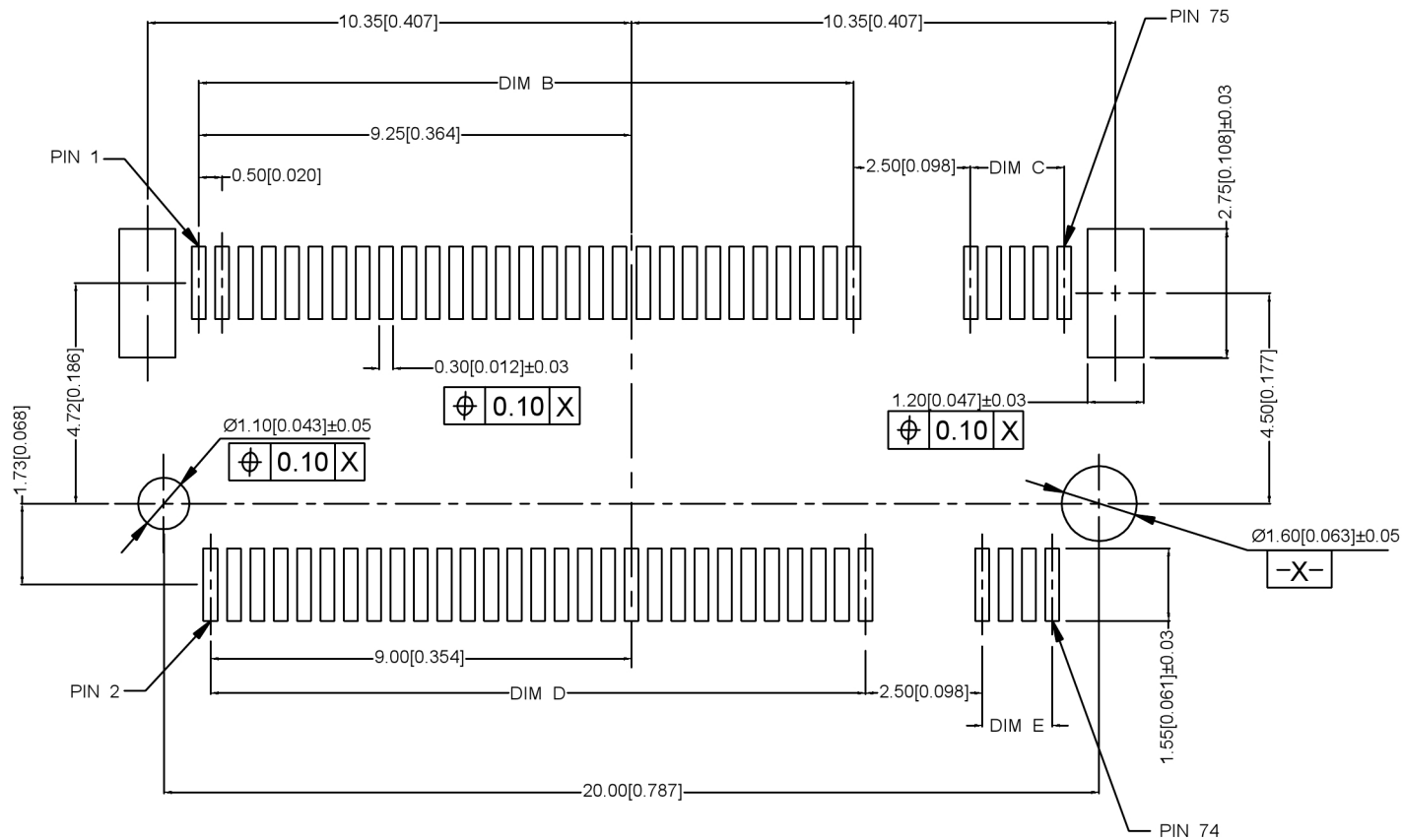

广东星坤科技股份有限公司

| | |
|------|-------|
| Δ | 日期 |
| Δ | 日期 |
| Δ | 日期 |
| MARK | 文件工程章 |

| REVISIONS | DESCRIPTION | DATE | REVISED | APPROVED | UNSPECIFIED TOLERANCES |
|-----------|-------------|------|---------|----------|------------------------|
| | | | | | ANGLAR ±5° |
| | | | | | L ≤ 4 ±0.2 |
| | | | | | 4 < L ≤ 16 ±0.3 |
| | | | | | 16 < L ≤ 63 ±0.4 |
| | | | | | L > 63 ±0.5 |



| | | |
|---------------------------------------|-------------|--------------------------------|
| DSND | SCALE: N/A | MODEL TYPE: |
| DWN | VIEW: | PART NO.: X1302WVS-67XX-LPV01 |
| CHKD | UNIT: mm/in | DWG NO.: X-X1302WVS-67XX-LPV01 |
| APPD | SIZE: A4 | WEIGHT SHEET REVISION |
| XKB INDUSTRIAL PRECISION CO., LIMITED | | 1/1 A0 |

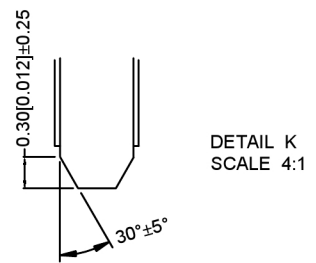
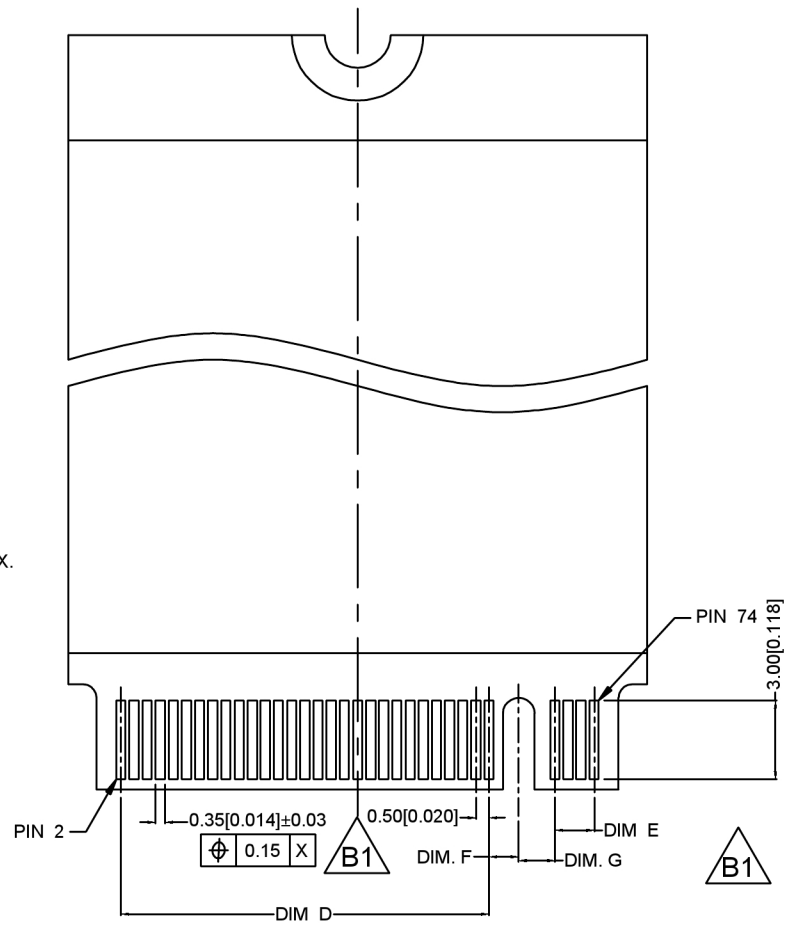
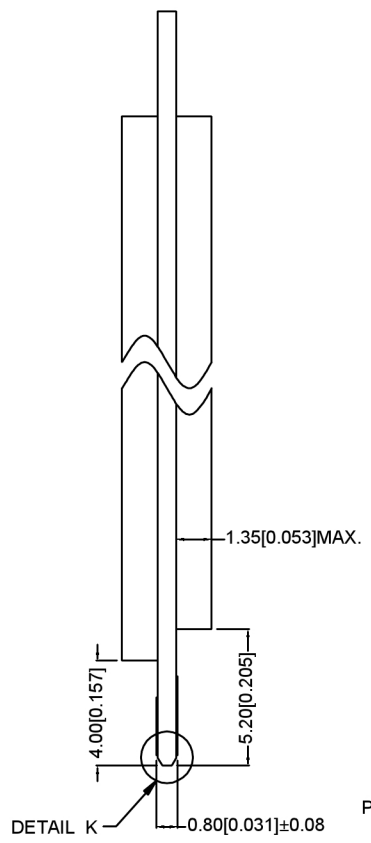
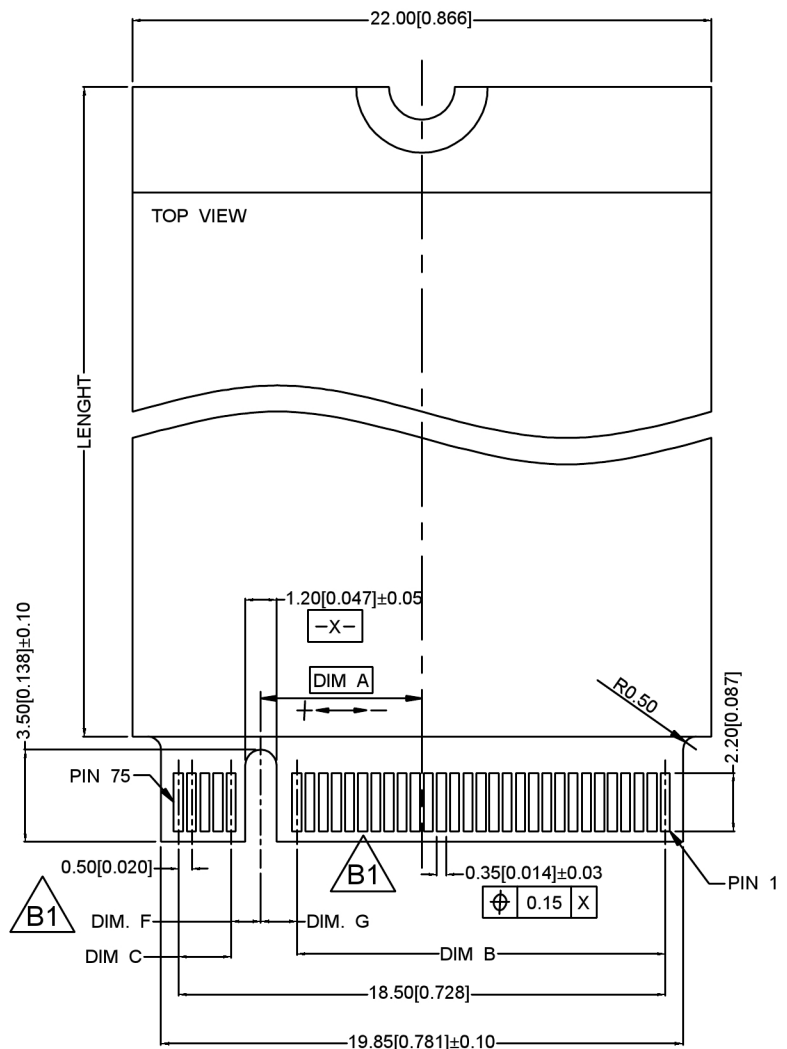

广东星坤科技股份有限公司

文件工程章

| | |
|------------------------|------|
| ANGLAR | ±5° |
| L ≤ 4 | ±0.2 |
| 4 < L ≤ 16 | ±0.3 |
| 16 < L ≤ 63 | ±0.4 |
| L > 63 | ±0.5 |
| UNSPECIFIED TOLERANCES | |



| | | |
|------|-------------|-----------------------|
| DSND | SCALE: N/A | MODEL TYPE: |
| DWN | VIEW: | PART NO.: |
| CHKD | UNIT: mm/in | X1302WWS-67XX-LPV01 |
| APPD | SIZE: A4 | DWG NO.: |
| | | X-X1302WWS-67XX-LPV01 |
| | | WEIGHT |
| | | SHEET |
| | | REVISION |
| | | 1/1 |
| | | A0 |

KXB INDUSTRIAL PRECISION CO., LIMITED

NOTES 注释:

1. MATERIAL材料:

1.1 HOUSING外壳: THERMOPLASTIC, HIGH TEMP.,
UL94V-0;
COLOR: BLACK.

1.2 CONTACTS触点: COPPER ALLOY.

1.3 FITTING NAIL装配钉: COPPER ALLOY.

2. FINISH饰面:

2.1 CONTACT触点:

[SEE TABLE] GOLD PLATING ON THE CONTACT AREA.
GOLD FLASH PLATING ON THE SOLDERING AREA.

1.27um~2.54um [50u"~100u"] MIN. NICKEL UNDERPLATING OVERALL

2.2 FITTING NAIL装配钉:

2.54um~5.08um [100u"~200u"] MIN. MATTE-TIN PLATING
ON THE SOLDERING AREA

1.27um~2.54um [50u"~100u"] MIN. NICKEL UNDERPLATING OVERALL.

X1302 W V S - 67 X X - LP V01

① ② ③ ④ ⑤ ⑥ ⑦ ⑧ ⑨

① Series Number

② Terminal form: W-Wafer

③ Welding Board Angle : V-Stright Angle 180°

④ Welding Way:S-SMT

⑤ No.of Pins: XX-67 PIN

⑥ HEIGHT: A 3.2mm;B 3.5mm;C 4.2mm;
D 5.5mm;E 6.7mm;F 8.5mm

⑦ KEY ID: A,B,C,D,E,F,G,H,J,K,L,M

⑧ Plastic material: LP-LCP UL94V-0

⑨ Contact Plating:V01-Gold Flash
V15 -Gold 15"u"
V30 -Gold 30"u"



| | | | | | | | |
|--------|--------|--------|--------|--------|--------|--------|--------|
| 1.375 | 1.125 | 1.5 | 14.0 | 2.0 | 14.0 | 6.125 | M |
| 1.375 | 1.125 | 2.5 | 13.0 | 3.0 | 13.0 | 5.125 | L |
| 1.375 | 1.125 | 3.5 | 12.0 | 4.0 | 12.0 | 4.125 | K |
| 1.375 | 1.125 | 4.5 | 11.0 | 5.0 | 11.0 | 3.125 | J |
| 1.375 | 1.125 | 5.5 | 10.0 | 6.0 | 10.0 | 2.125 | H |
| 1.375 | 1.125 | 6.5 | 9.0 | 7.0 | 9.0 | 1.125 | G |
| DIM. G | DIM. F | DIM. E | DIM. D | DIM. C | DIM. B | DIM. A | KEY ID |



| | | | | | | | |
|--------|--------|--------|--------|--------|--------|--------|--------|
| 1.125 | 1.375 | 9.5 | 6.0 | 9.5 | 6.5 | -1.625 | F |
| 1.125 | 1.375 | 10.5 | 5.0 | 10.5 | 5.5 | -2.625 | E |
| 1.125 | 1.375 | 11.5 | 4.0 | 11.5 | 4.5 | -3.625 | D |
| 1.125 | 1.375 | 12.5 | 3.0 | 12.5 | 3.5 | -4.625 | C |
| 1.125 | 1.375 | 13.5 | 2.0 | 13.5 | 2.5 | -5.625 | B |
| 1.125 | 1.375 | 14.5 | 1.0 | 14.5 | 1.5 | -6.625 | A |
| DIM. G | DIM. F | DIM. E | DIM. D | DIM. C | DIM. B | DIM. A | KEY ID |

广东星坤科技股份有限公司

| | |
|----|----|
| 姓名 | 日期 |
| 数量 | 日期 |
| 数量 | 日期 |

文件工程章

| MARK | DESCRIPTION | DATE | REVISED | APPROVED | UNSPECIFIED TOLERANCES |
|------|-------------|------|---------|----------|------------------------|
| | | | | | ANGULAR ±5° |
| | | | | | L ≤ 4 ±0.2 |
| | | | | | 4 < L ≤ 16 ±0.3 |
| | | | | | 16 < L ≤ 63 ±0.4 |
| | | | | | L > 63 ±0.5 |



| | | |
|---------------------------------------|-------------|--------------------------------|
| DSND | SCALE: N/A | MODEL TYPE: |
| DWN | VIEW: | PART NO.: X1302WVS-67XX-LPV01 |
| CHKD | UNIT: mm/in | DWG NO.: X-X1302WVS-67XX-LPV01 |
| APPD | SIZE: A4 | WEIGHT SHEET REVISION |
| XKB INDUSTRIAL PRECISION CO., LIMITED | | 1/1 A0 |

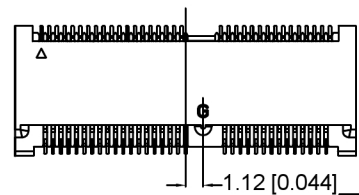
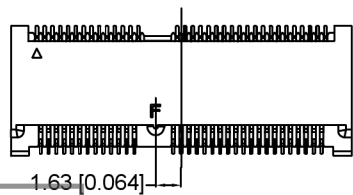
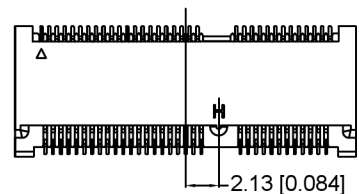
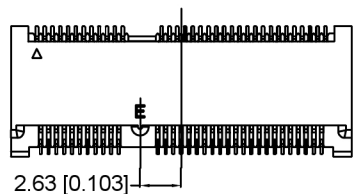
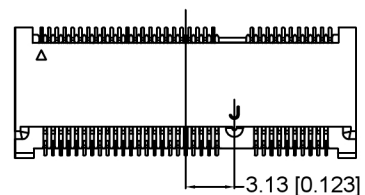
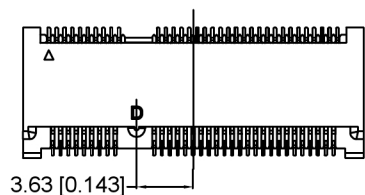
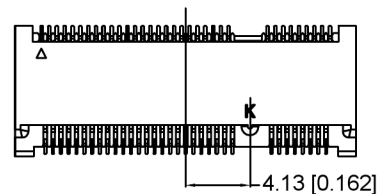
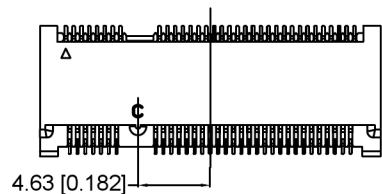
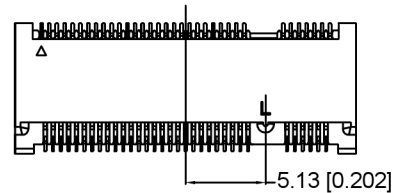
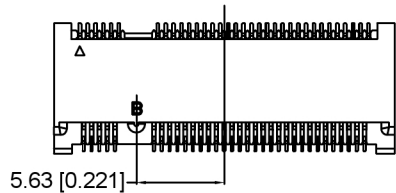
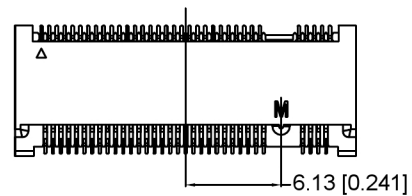
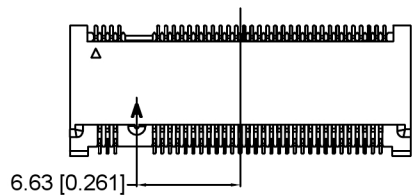

广东星坤科技股份有限公司

生效 MARK 日期

文件工程章

| DESCRIPTION | DATE | REVISED | APPROVED | UNSPECIFIED TOLERANCES |
|-------------|------|---------|----------|------------------------|
| | | | | ANGULAR ±5° |
| | | | | L ≤ 4 ±0.2 |
| | | | | 4 < L ≤ 16 ±0.3 |
| | | | | 16 < L ≤ 63 ±0.4 |
| | | | | L > 63 ±0.5 |

REVISIONS
www.helloxkb.com www.helloxkb.cn www.xk-dg.cn

| | | |
|---------------------------------------|-------------|--------------------------------|
| DSND | SCALE: N/A | MODEL TYPE: |
| DWN | VIEW: | PART NO.: X1302WWS-67XX-LPV01 |
| CHKD | UNIT: mm/in | DWG NO.: X-X1302WWS-67XX-LPV01 |
| APPD | SIZE: A4 | WEIGHT SHEET REVISION |
| XKB INDUSTRIAL PRECISION CO., LIMITED | | 1/1 A0 |

