

(For Reference Only) Stated At Compression

NOTES:

- 1:MATERIAL
1-1: SUS-304 THICKNE=0.10MM
- 2:SPECIFICATIONS
2-1: RATED CURRENT: 1.0A
2-2: VOLTAGE RATING: 1.5V
2-3: CONTACT RESISTANCE: 80mΩ/MAX
2-4: WELDING THRUST: ≥3KG
2-5: OPERATING TEMPERATURE: -40°C~+85°C
- 3:DURABILITY: 1500 CYCLES
- 4:SALT SPRAY TIME: 24H
- 5:ELECTROPLATE: THE NICKEL-PLATED SUBSTRATE IS 50u" MIN
- 6:REQUIREMENTS
6-1:TERMINAL TO EAT FULL TIN,NOTPEELING, WELDING OBVIOUS COLOR AND OTHER ADVERSE
6-2:ROHS.REACH.HF HALOGER ADVERSE OF DOMESTIC AND INTERNATIONAL ENVIRONMNTAL REQUIREMENTS

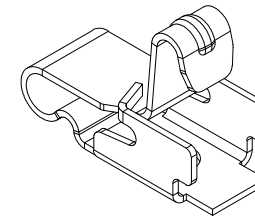
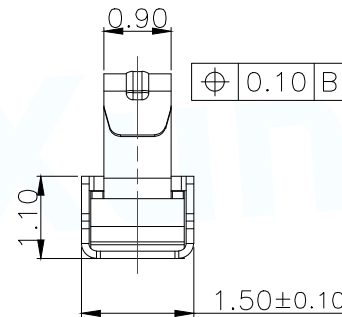
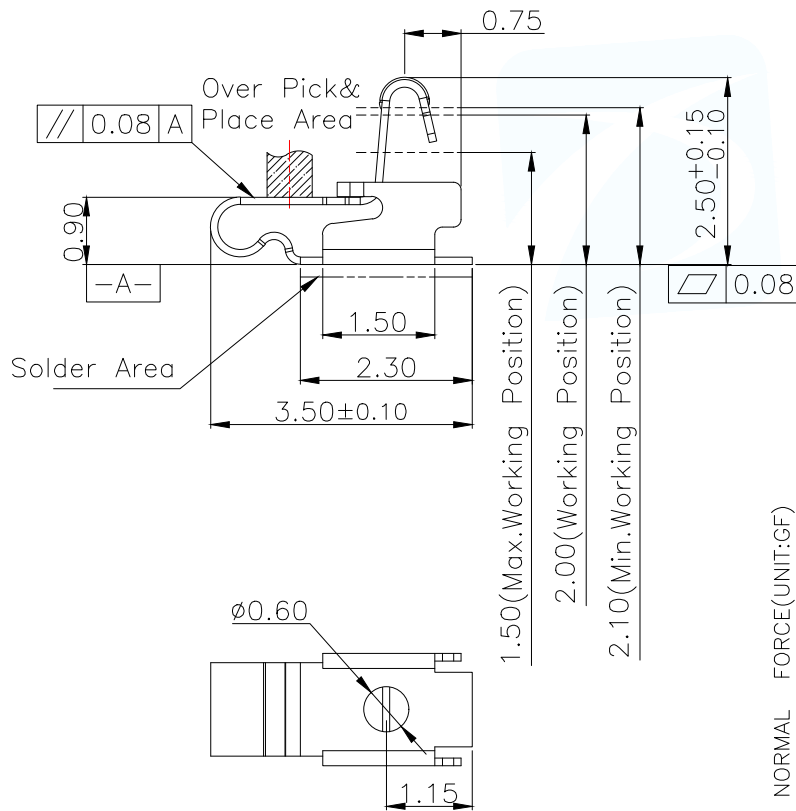

3D View

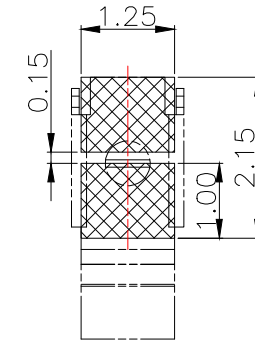

RECOMMENDED PCB LAYOUT

TOLERANCE:±0.05MM (FOR REFERENCE ONLY)

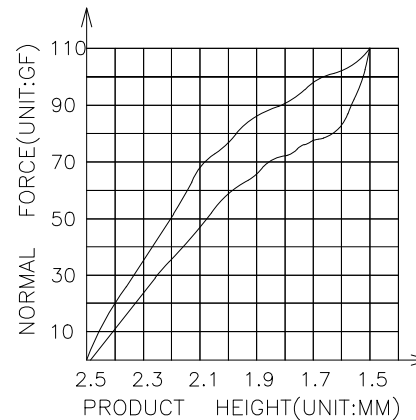

MANUFACTURE DWG		东莞市讯普电子科技有限公司 DongGuan XunPu Electronics Co.,Ltd	
UNLESS OTHERWISE SPECIFIED TOLERANCES			TITLE: 天线弹片 L3.50*W1.50*H2.50
DECIMALS:	ANGLES:		PAR ASP-D2506-A01
X.:±0.30	X':±2°		DWN Lucas
X.X:±0.20	X.X':±1°		CHKD Ethan
X.XX:±0.15	X.XX':±0.5°	CUSTOMER COPY	APVD Jacob
		SCALE:1:1	UNIT:MM
		SIZE:A4	UNIT:MM
		SHEET:1F1	REV:A

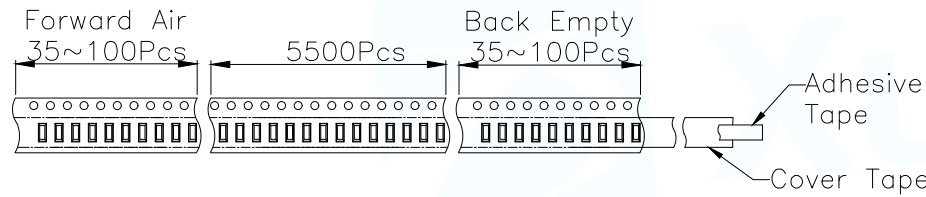
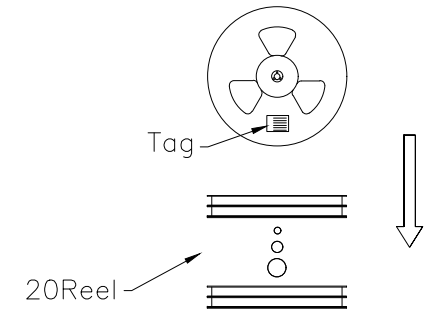
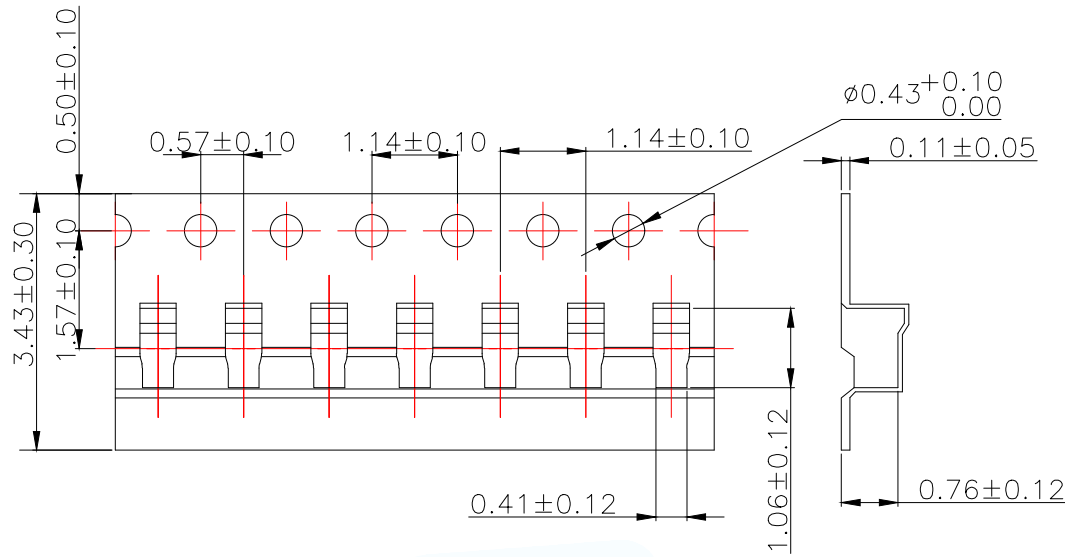

Carton Size
290*330*4 K3K

Carton Size
345*345*360 K=K

Customer To Use Direction

Pull Out Direction
(出料方向)

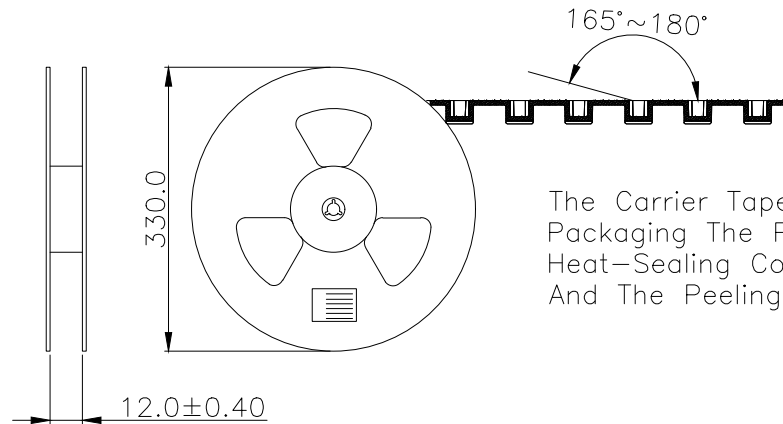

The Carrier Tape Is Heat-Sealed Packaging The Peeling Angle Of The Heat-Sealing Cover Tape Is $165^\circ \sim 180^\circ$ And The Peeling Force Is 30~120g.

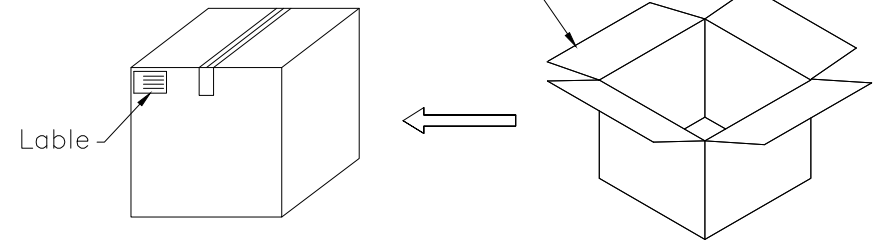

MANUFACTURE DWG		东莞市讯普电子科技有限公司 DongGuan XunPu Electronics Co.,Ltd	
UNLESS OTHERWISE SPECIFIED TOLERANCES			TITLE: 天线弹片 L3.50*W1.50*H2.50
			PAR ASP-D2506-A01
DECIMALS:	ANGLES:		DWN Lucas
X.:±0.30	X':±2'		CHKD Ethan
X.X:±0.20	X.X':±1'	APVD Jacob	SCALE:1:1 UNIT:MM
X.XX:±0.15	X.XX':±0.5'	CUSTOMER COPY	SIZE:A4 SHEET:1F1 REV:A