

版次	0	变更摘要	初版发行	日期	2022/08/07	序号	(NO.)	品名	(Name)	材质	(Material)
						①	MX2.0 Pitch B型卧式	WB胶芯	铜合金/表面镀锡	铜合金/表面镀锡	铜合金/表面镀锡
						②	MX2.0 Pitch B型卧式	WB端子	铜合金/表面镀锡	铜合金/表面镀锡	铜合金/表面镀锡
						③	MX2.0 Pitch B型卧式	WB焊片	铜合金/表面镀锡	铜合金/表面镀锡	铜合金/表面镀锡

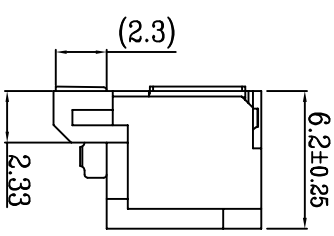
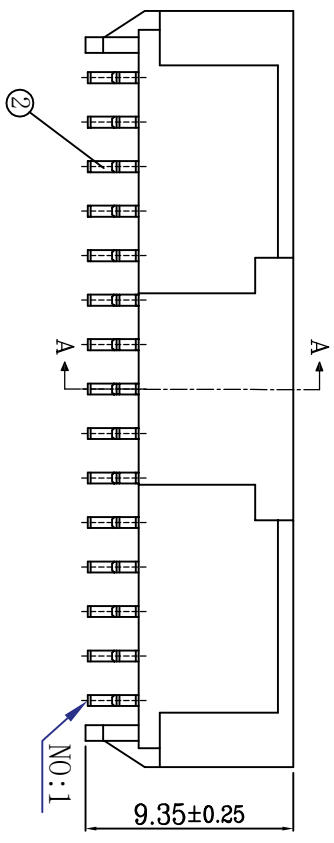
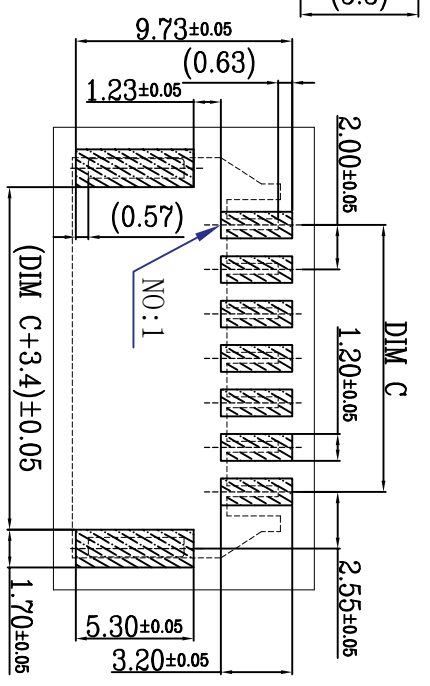
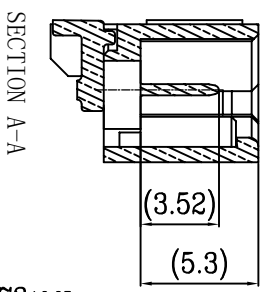
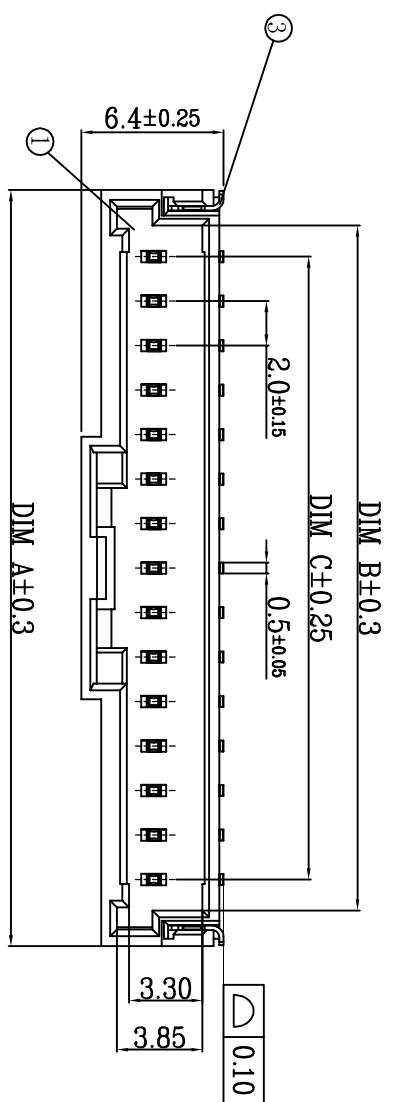

适用线路板 (PCB LAYOUT)

CKT	DIM A	DIM B	DIM C
2	8.00	4.80	2.00
3	10.00	6.80	4.00
4	12.00	8.80	6.00
5	14.00	10.80	8.00
6	16.00	12.80	10.00
7	18.00	14.80	12.00
8	20.00	16.80	14.00
9	22.00	18.80	16.00
10	24.00	20.80	18.00
11	26.00	22.80	20.00
12	28.00	24.80	22.00
13	30.00	26.80	24.00
14	32.00	28.80	26.00
15	34.00	30.80	28.00

技术指标:

1. 塑件表面应光洁、无毛边、无明显收缩、缺陷、裂纹等现象。
2. 温度范围: -25° C~85° C.
3. 额定电压: 125V, AC/DC.
4. 额定电流: 2.0A AC DC (AWG#24, 0. D1.4mm MAX)
5. 接触电阻: ≤40mΩ.
6. 绝缘电阻: ≥1000MΩ.
7. 耐电压: 500V AC/Minute

8. 产品料号:

WT200BW*** **

NO. OF CKT (产品PIN数)

Plating(电镀方式)

0: 端子全雾锡

1: 端子全金 (G/F OVERALL)

4: 端子全亮锡

00 胶芯全镀金

01 胶芯全镀锡

Packing (包装方式)

R: TAPE & REEL 卷装



一般公差 (TOLERANCE)
X ±.50 XX ±.10
X ±.20 XXX ±.05
ANGLES ±1°

ZGWPD 浙江温达电子有限公司
ZHEJIANG WENDA ELECTRONICS CO., LTD

品名 (TITLE) MX2.0 Pitch B型卧式WB业务图

料号 (DRAWING) WT200BW*** **

比例 (SCALE) 1:1

单位 (UNITS) mm

张数 (SHEET) 1 OF 4

制图 (DR) Anlan

校对 (CHECK) 李绍宗

审核 (APP) 黄志明

尺寸 (SIZE) A4

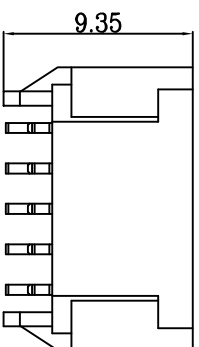
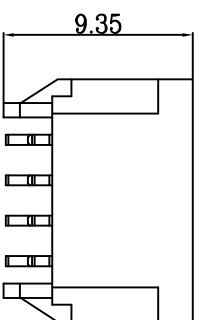
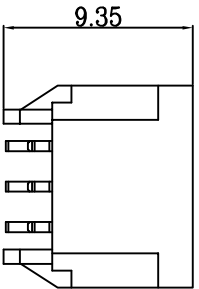
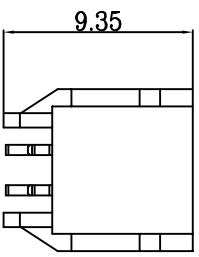
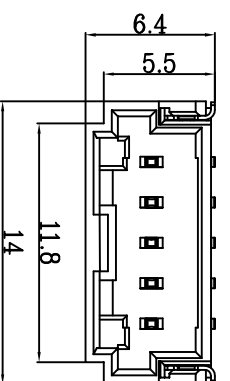
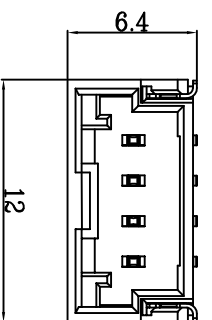
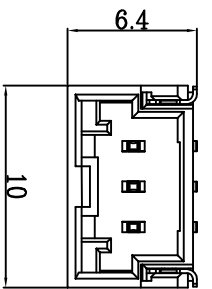
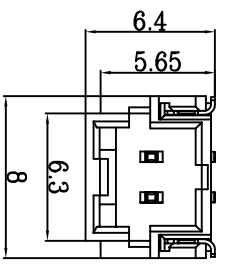

2P

3P

4P

5P

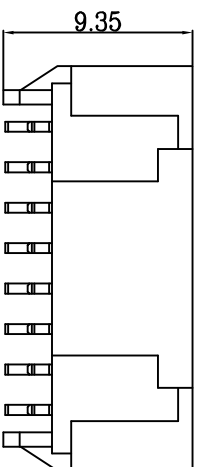
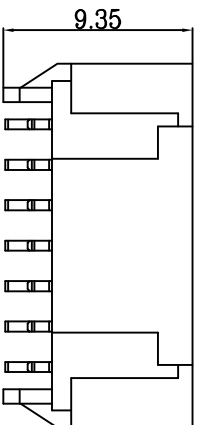
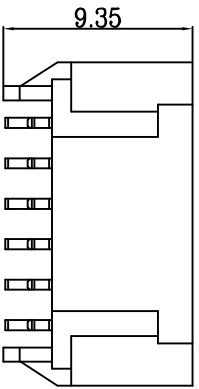
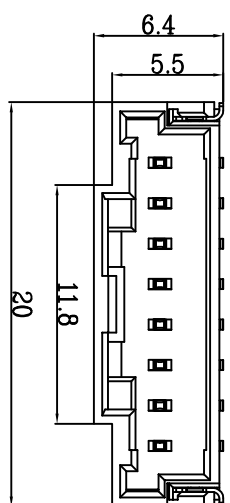
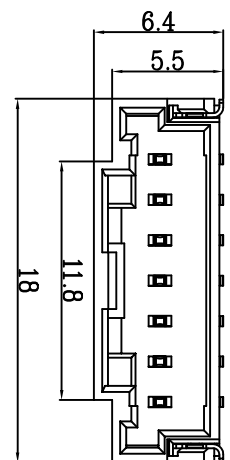
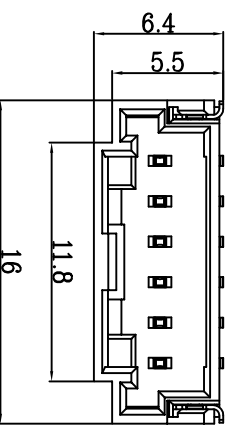

6P

7P

8P



一般公差 (TOLERANCE)
 X ±.50 XX ±.10
 Y ±.20 ZXX ±.05
 ANGLES ±1°

ZGWD 浙江温达电子有限公司
 ZHEJIANG WENDA ELECTRONICS CO., LTD

品名 (NAME) MX2.0 Pitch B型卧式WTB业务图
 料号 (DRAWING) WT200BW-***-***-***
 比例 (SCALE) 1:1
 单位 (UNITS) mm

制图 (DR) Anlan
 校对 (CHECK) 李绍宗
 审核 (APP) 黄志明
 张数 (SHEET) 2 OF 4
 尺寸 (SIZE) A4
 版次 (REV) A

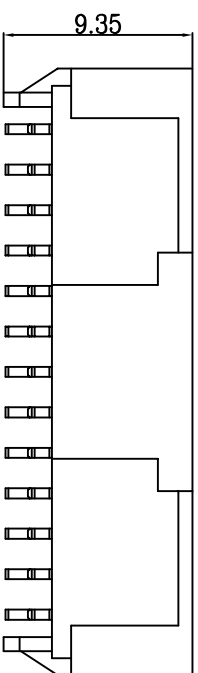
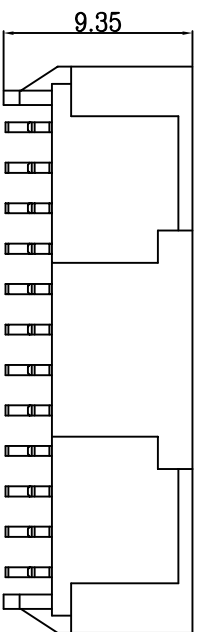
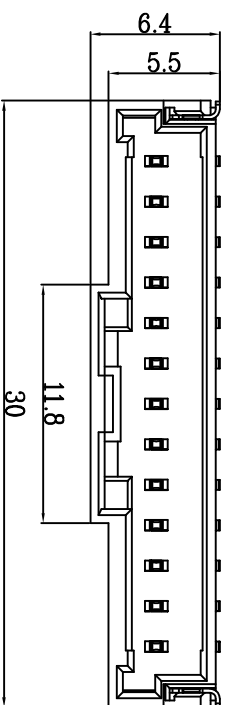
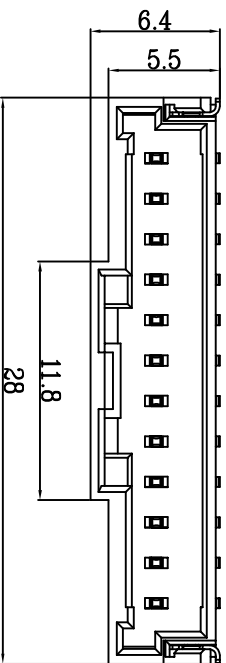
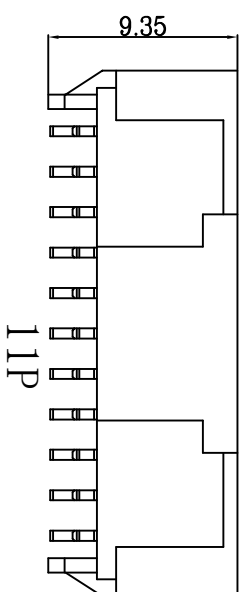
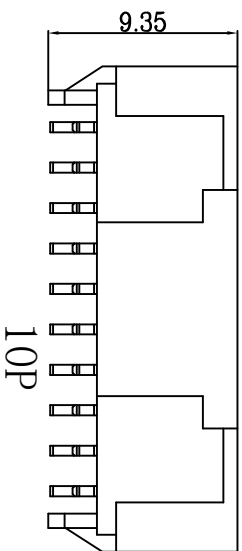
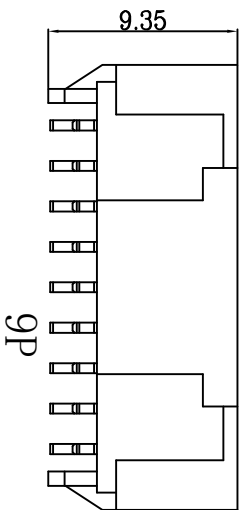
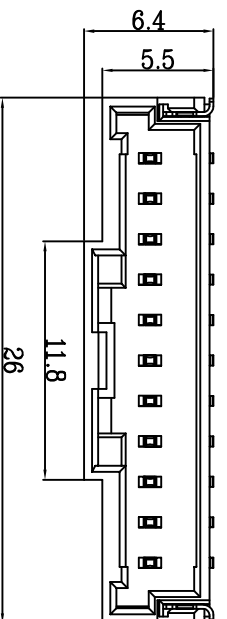
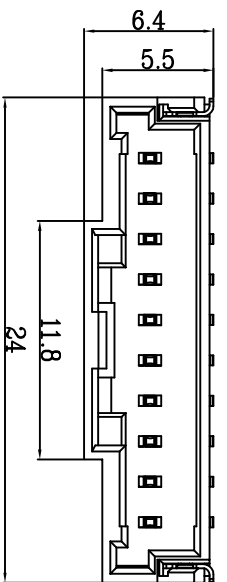
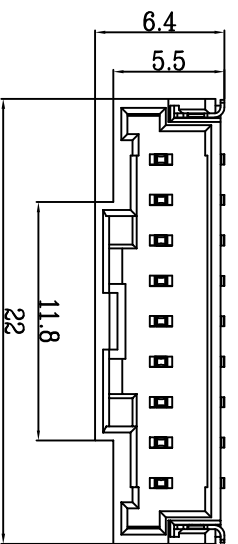

12P

13P



一般公差 (TOLERANCE)
 X ±.50 XX ±.10
 Y ±.20 ZXX ±.05
 ANGLES ±1°

ZGWD 浙江温达电子有限公司
 ZHEJIANG WENDA ELECTRONICS CO., LTD

品名 (TITLE) MV2.0 Pitch B型卧式WTB业务图
 料号 (DRAWING) WT200BW-***-***

制图 (DR) AnLan
 校对 (CHECK) 李绍宗

审核 (APP) 黄志明
 张数 (SHEET) 3 OF 4

比例 (SCALE) 1:1
 单位 (UNITS) mm

尺寸 (SIZE) A4
 版次 (REV) A

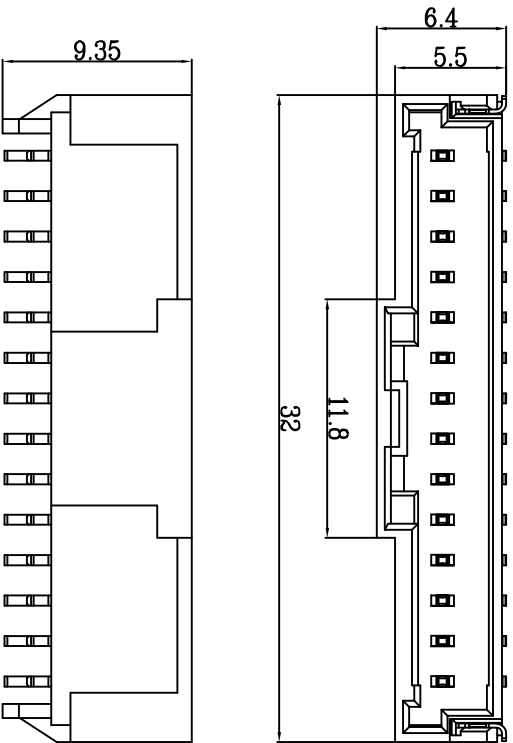

14P

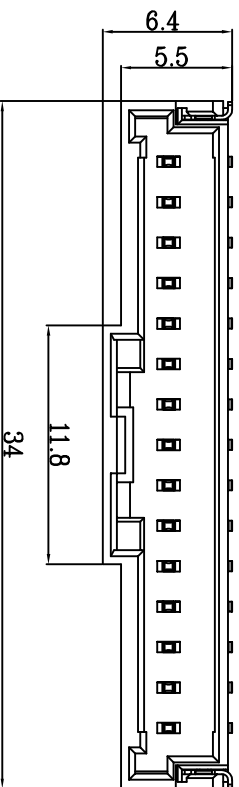

15P



一般公差 (TOLERANCE)
 X ±.50 XX ±.10
 Y ±.20 .XXX ±.05
 ANGLES ±1°

ZGWWD 浙江温达电子有限公司
 ZHEJIANG WENDA ELECTRONICS CO., LTD

品名 (TITLE) MX2.0 Pitch B型卧式WTB业务图
 料号 (DRAWING) WT200BW-***-***

比例 (SCALE) 1:1	单位 (UNITS) mm	张数 (SHEETS) 4 Of 4	审核 (APPR) 李绍宗	制图 (DR) AnLan
校对 (CHECK) 李绍宗	审核 (APPR) 黄志明	尺寸 (SIZE) A4	版数 (REV) A	