

版次	0	变更摘要	初版发行	日期	2022/08/07	序号	(NO.)	品名	(Name)	材质	(Material)
						①		MX2.0 Pitch B型立式	WTB底座	PAST 0134 V-0	颜色: 本色
						②		MX2.0 Pitch B型立式	WTB端子	铜合金/表面镀锡	
						③		MX2.0 Pitch B型立式	WTB焊片	铜合金/表面镀锡	

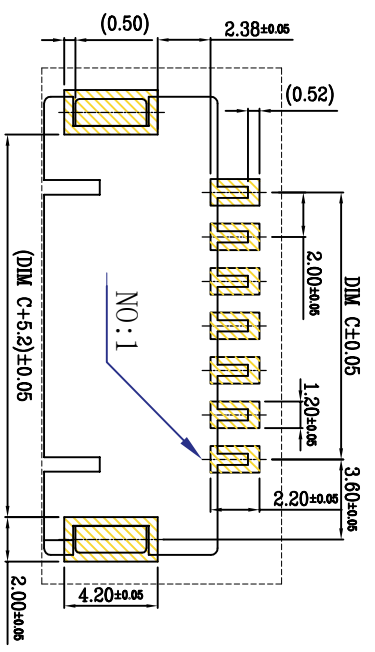
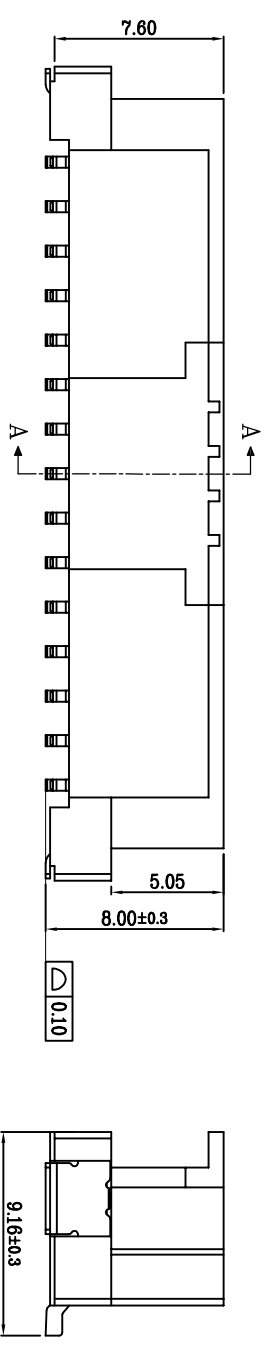
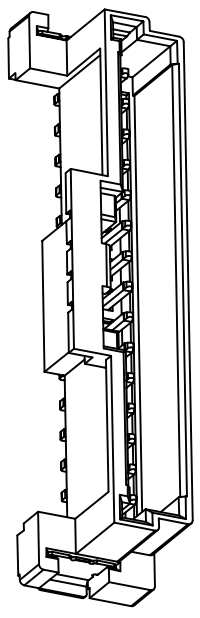
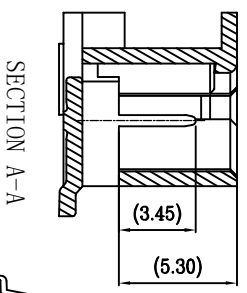
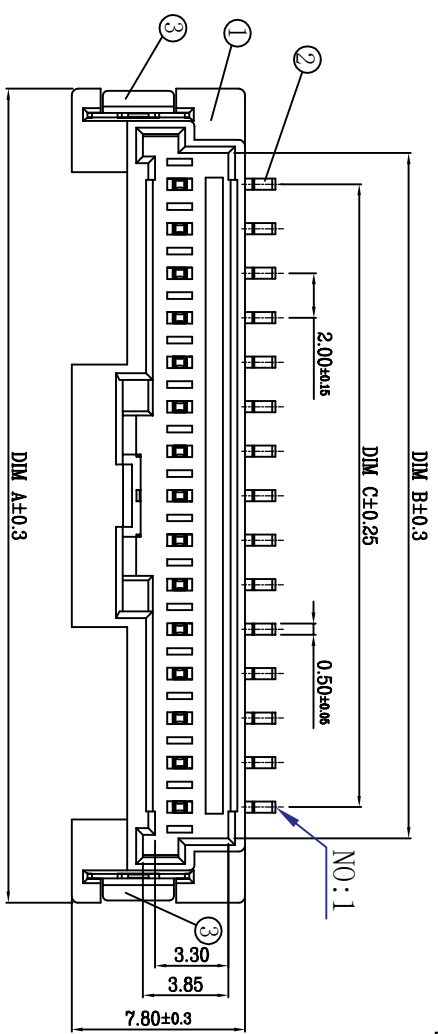

CKT	DIM A	DIM B	DIM C
1	10.90	4.80	2.00
2	12.60	6.80	4.00
3	14.60	8.80	6.00
4	16.60	10.80	8.00
5	18.60	12.80	10.00
6	20.60	14.80	12.00
7	22.60	16.80	14.00
8	24.60	18.80	16.00
9	26.60	20.80	18.00
10	28.60	22.80	20.00
11	30.60	24.80	22.00
12	32.60	26.80	24.00
13	34.60	28.80	26.00
14	36.60	30.80	28.00

技术指标:

1. 塑件表面应光洁、无毛边、无明显收缩、缺陷、裂纹等现象。
2. 温度范围: -25° C~85° C.
3. 额定电压: 125V, AC/DC.
4. 额定电流: 2.0A AC DC(AWG#24, 0. D1. 4mm MAX)
5. 接触电阻: ≤40mΩ.
6. 绝缘电阻: ≥1000MΩ.
7. 耐压: 500V AC/Minute
8. 产品料号: WT200BL-\*\*\*-\*\*-\*\*\*



适用线路板 (PCB LAYOUT)



一般公差 (TOLERANCE)  
 X ±.50 XX ±.10  
 X ±.20 XXX ±.05  
 ANGLES ±1°

**ZGWD** 浙江温达电子有限公司  
 ZHEJIANG WENDA ELECTRONICS CO., LTD

品名 (TITLE) MX2.0 Pitch B型立式WTB业务图  
 料号 (DRAWING) WT200BL-\*\*\*-\*\*-\*\*\*  
 比例 (SCALE) 1:1  
 单位 (UNITS) mm  
 张数 (SHEET) 1 OF 4  
 尺寸 (SIZE) A4  
 审核 (APPD) 黄志明  
 校对 (CHECKD) 李绍宗

1 2 3 4 5 A B C D E F

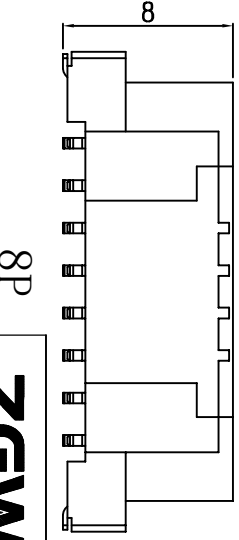
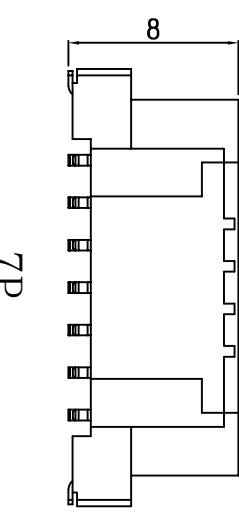
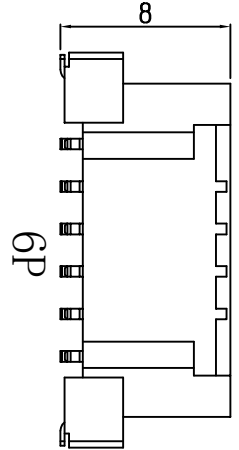
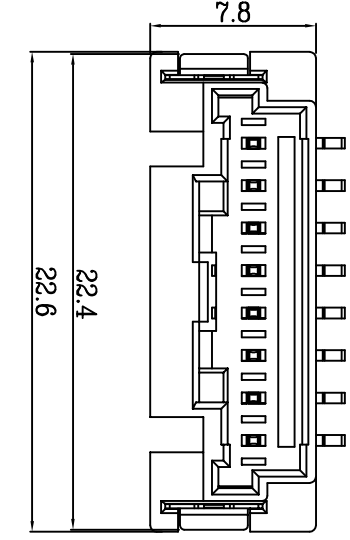
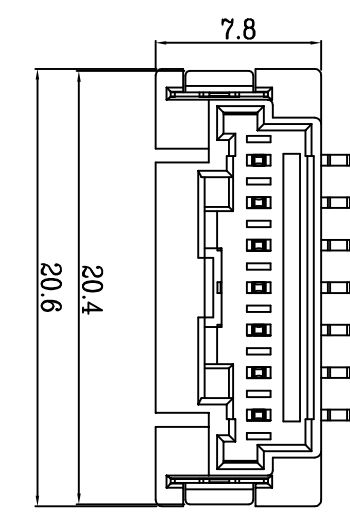
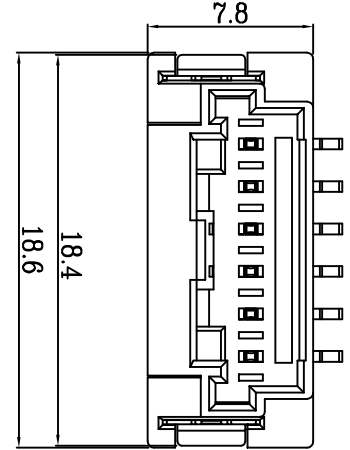
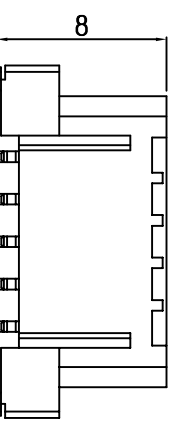
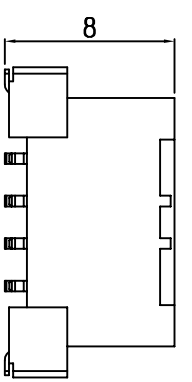
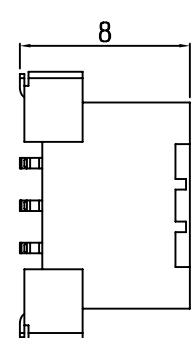
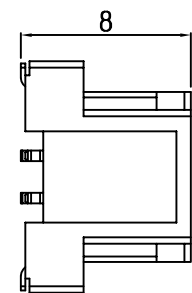
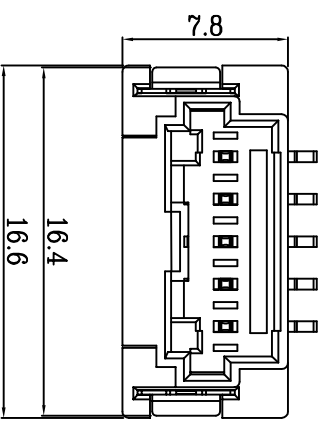
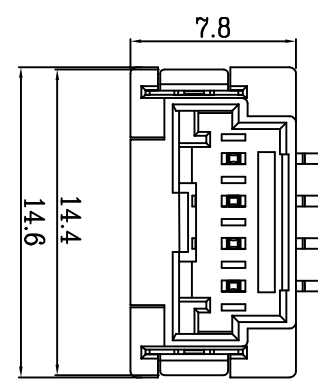
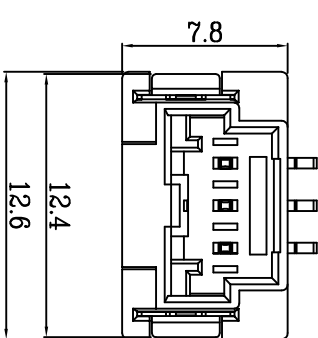
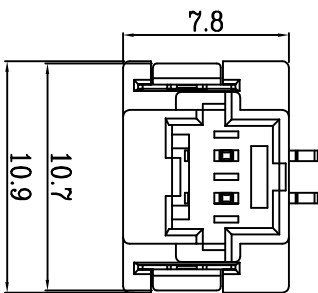

**ZGWD** 浙江温达电子有限公司  
ZHEJIANG WENDA ELECTRONICS CO., LTD

品名 (TITLE) MX2.0 Pitch B型立式WTB业务图  
料号 (DRAWING) WT200BL-\*\*-\*\*-\*\*

制图 (DR) Anlan  
校对 (CHECK) 李绍宗  
审核 (APPV) 黄志明

比例 (SCALE) 1:1  
单位 (UNITS) mm  
张数 (SHEET) 2 OF 4  
尺寸 (SIZE) A4  
图例 (SYMBOL) A

一般公差 (TOLERANCE)  
X ±.50 XX ±.10  
Y ±.20 ZXX ±.05  
ANGLES ±1°

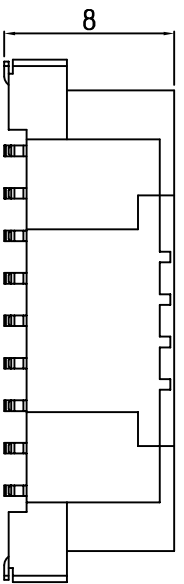
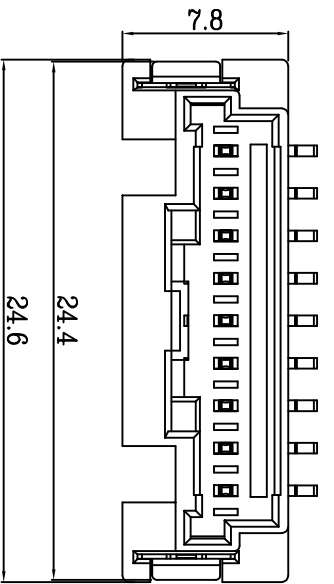

9P

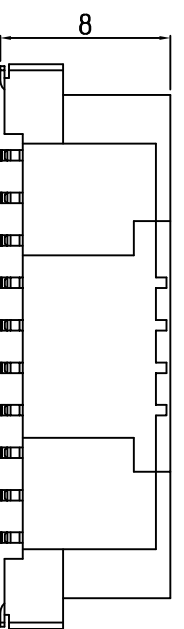
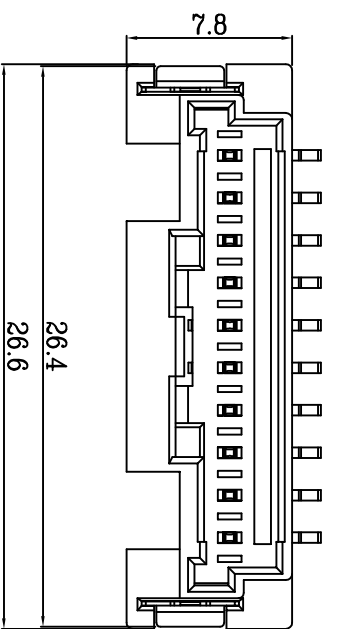

10P

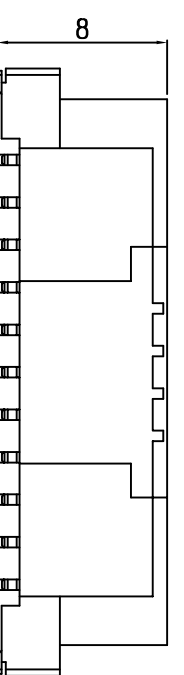
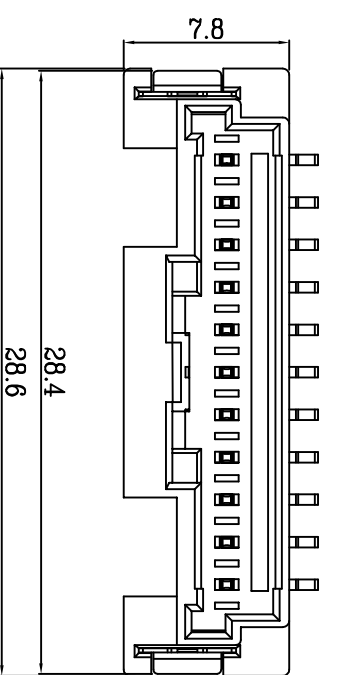

11P

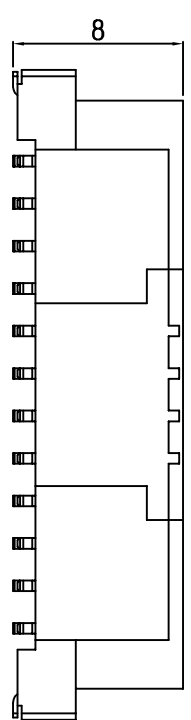
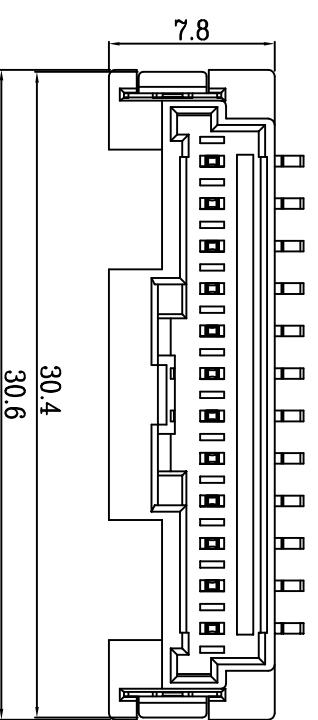

12P

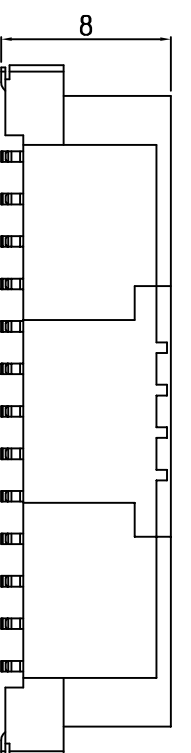
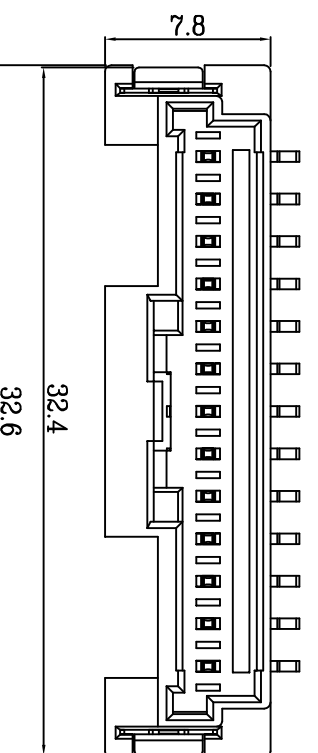

13P



**ZGWD** 浙江温达电子有限公司  
ZHEJIANG WENDA ELECTRONICS CO., LTD

品名 (TITLE) MX2.0 Pitch B型立式WTB业务图  
料号 (DRAWING) WT200BL-\*\*\*-\*\*\*

制图 (DR) Anlan  
校对 (CHECK) 李绍宗  
审核 (APPV) 黄志明

比例 (SCALE) 1:1  
单位 (UNITS) mm  
张数 (SHEET) 3 OF 4  
尺寸 (SIZE) A4  
图例 (SYMBOL)

一般公差 (TOLERANCE)  
X ±.50 XX ±.10  
X ±.20 XXX ±.05  
ANGLES ±1°

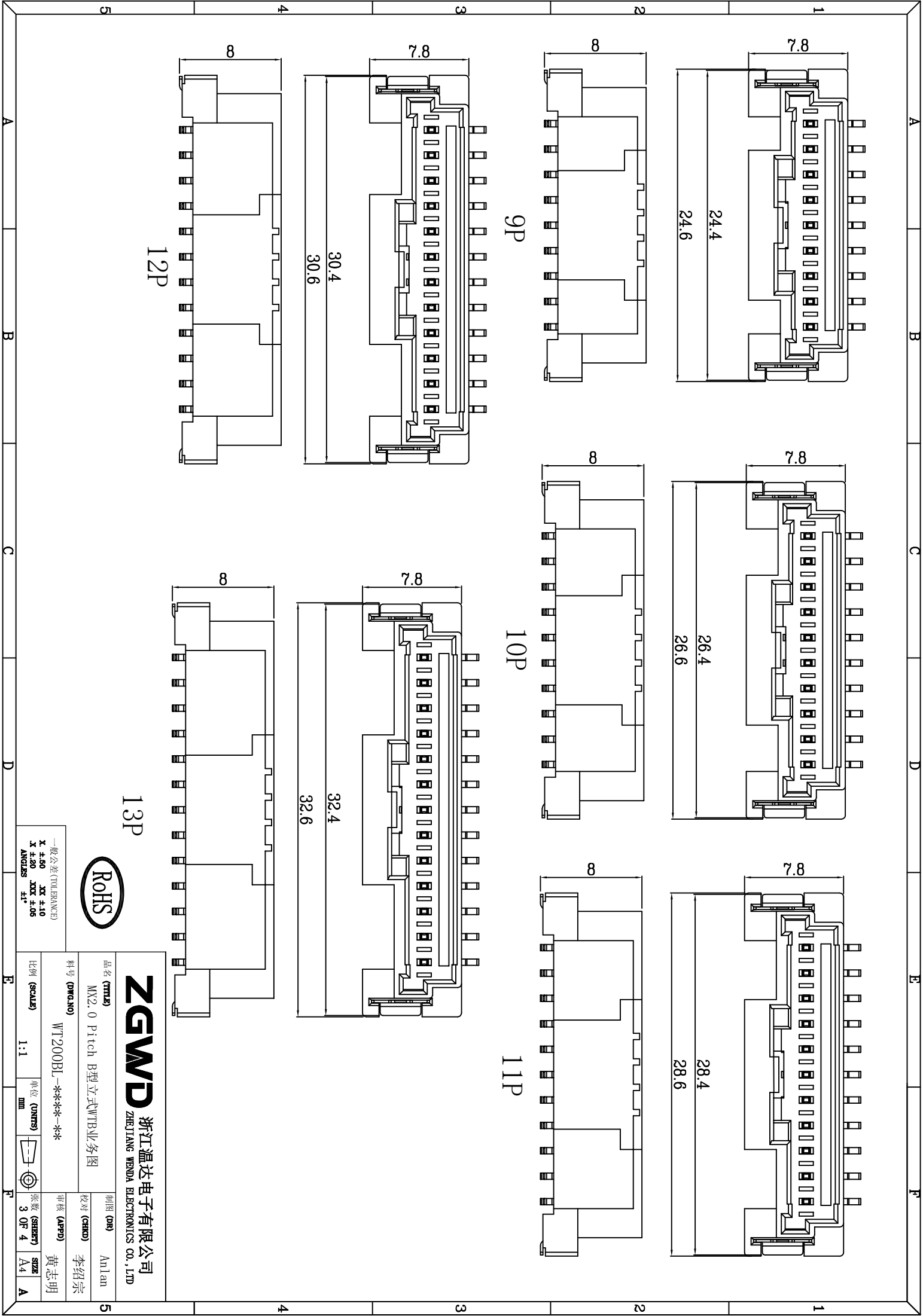

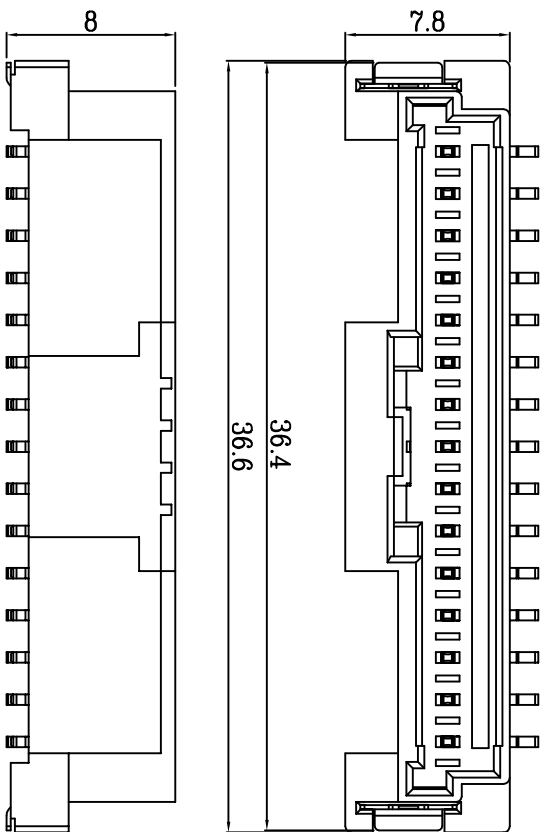
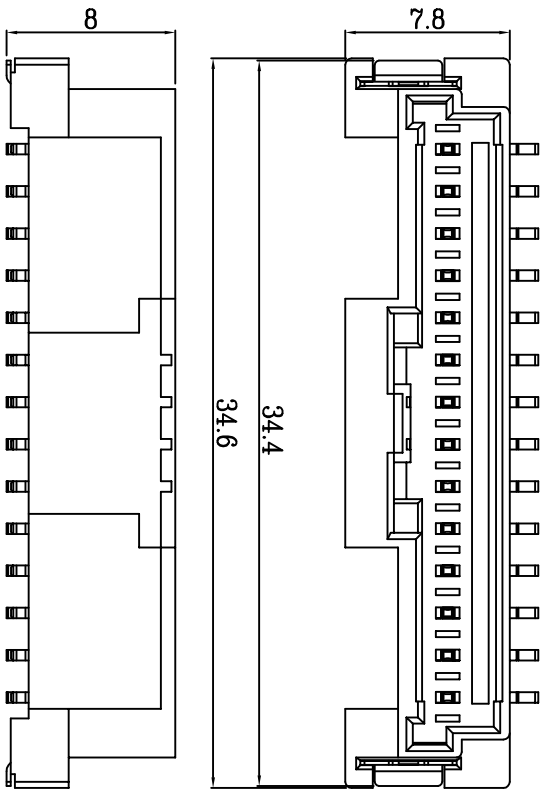

一般公差 (TOLERANCE)  
 X ±.50 XX ±.10  
 Y ±.20 ZXX ±.05  
 ANGLES ±1°

**ZGWD** 浙江温达电子有限公司  
 ZHEJIANG WENDA ELECTRONICS CO., LTD

品名 (TITLE) MX2.0 Pitch B型立式WTB业务图  
 料号 (DRAWING) WT200BL-\*\*-\*\*-\*\*

比例 (SCALE)	1:1	单位 (UNITS)	mm	张数 (SHEET)	4 Of 4	尺寸 (SIZE)	A4
制图 (DR)	Anlan	审核 (APP)	李绍宗	校对 (CHKD)	李绍宗	审核 (APP)	黄志明