

版次	变更摘要	日期	序号	品名	材质
0	新产品发行	2023/03/07			

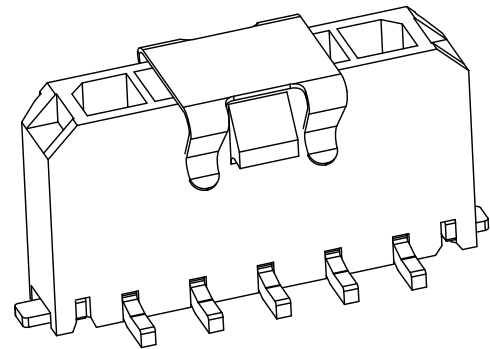

①	MX3.0单排卧式胶芯	LCP UL94V-0 黑色
②	MX3.0单排立式端子	铜合金/表面镀锡
③	MX3.0单排立式焊片	铜合金/表面镀锡
④	MX3.0单排立式吸盖	不锈钢

- 技术指标:
1. 温度范围: -25° C~85° C.
  2. 额定电流: 5.0A AC DC.
  3. 额定电压: 250V AC DC.
  4. 耐电压: 1000V AC/minute.
  5. 接触电阻: ≤20mΩ .
  6. 绝缘电阻: ≥1000MΩ.
  7. 产品料号:

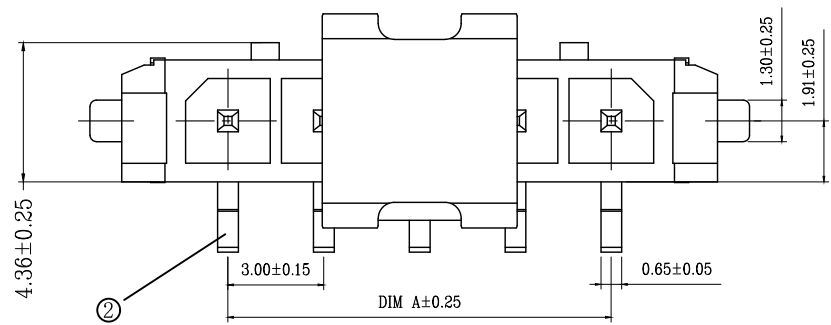
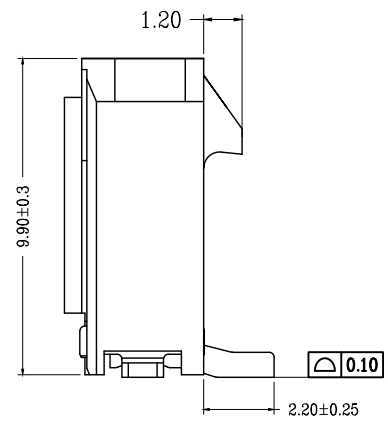
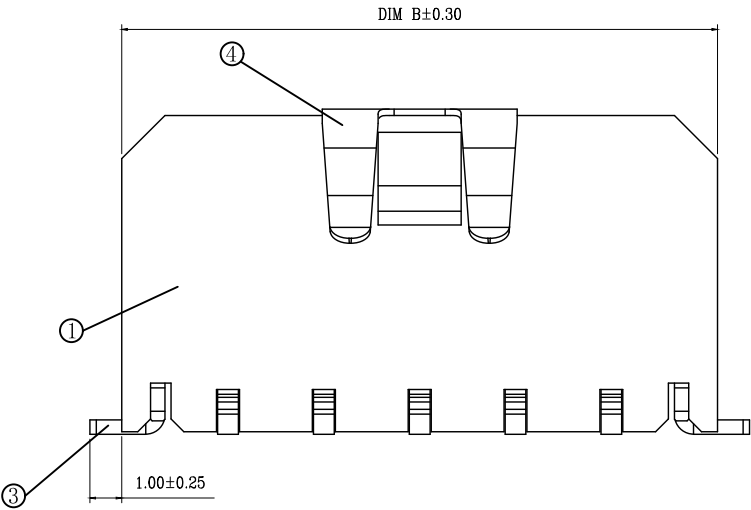

WT5557L-\*\*\* \*\*-\*

NO OF CKT (产品PIN数) 00 胶芯有LOGO:WD  
0W 胶芯无LOGO

Plating (电镀方式) R:TAPE & REEL卷装  
C:TAPE & REEL WITH COVER加吸盖卷装

Packing (包装方式)

CKT	DIM A	DIM B
2	3.00	9.65
3	6.00	12.65
4	9.00	15.65
5	12.00	18.65
6	15.00	21.65
7	18.00	24.65
8	21.00	27.65
9	24.00	30.65
10	27.00	33.65
11	30.00	36.65
12	33.00	39.65

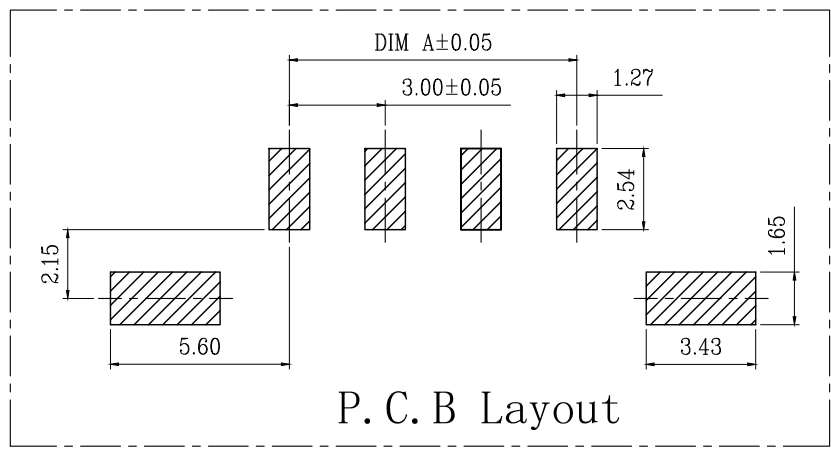

一般公差 (TOLERANCE)  
 X ±.50 .XX ±.10  
 Y ±.20 .XXX ±.05  
 ANGLES ±1°

## ZGWD 浙江温达电子有限公司

ZHEJIANG WENDA ELECTRONICS CO., LTD

品名 (TITLE) MX3.0 单排立式WTB业务图	制图 (DR) Anlan
料号 (DWG.NO) WT5557L-****-***	校对 (CHKD) 李绍宗
比例 (SCALE) 1:1	审核 (APPD) 黄志明
单位 (UNITS) mm	张数 (SHEET) 1 OF 2
尺寸 (SIZE) A4	REV A

A

B

C

D

E

F

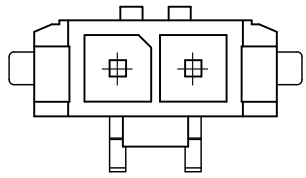

2PIN

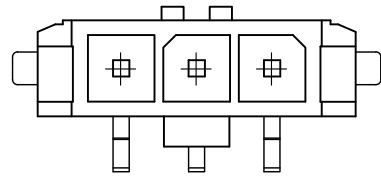

3PIN

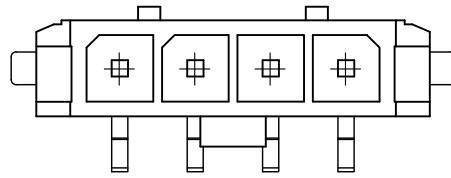

4PIN

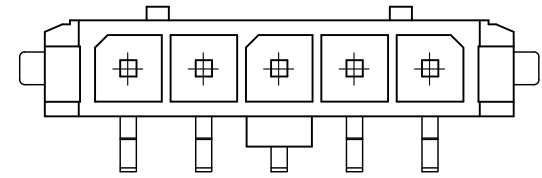

5PIN

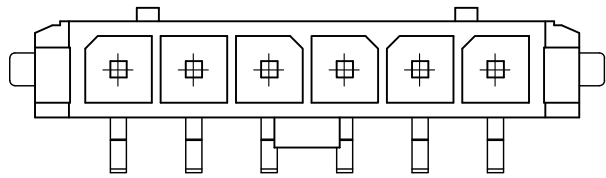

6PIN

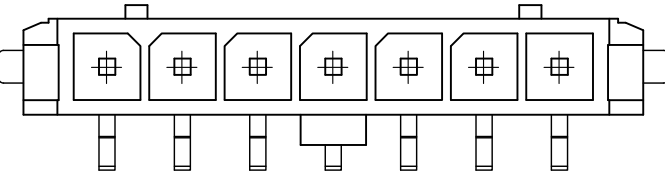

7PIN

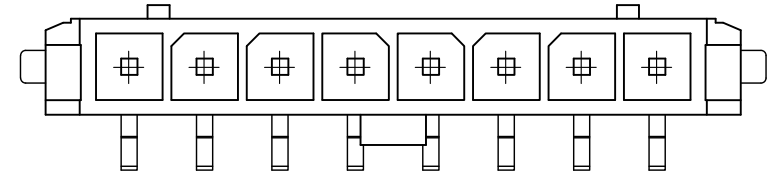

8PIN

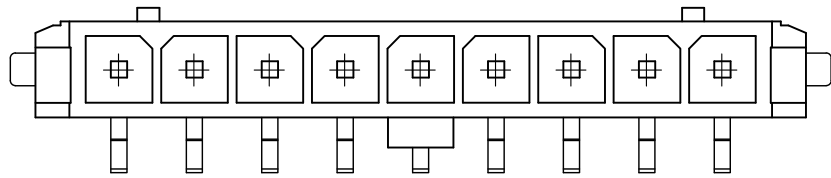

9PIN

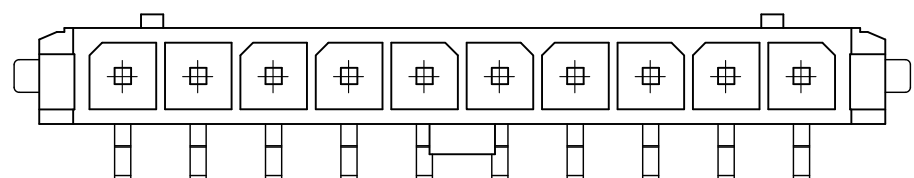

10PIN

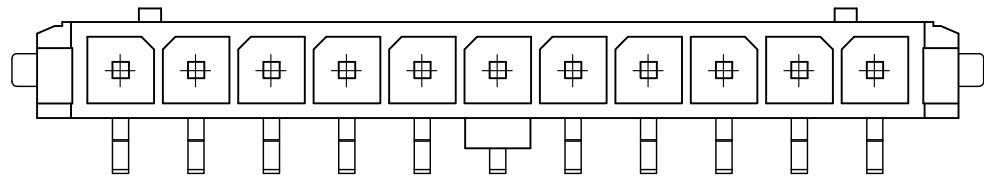

11PIN

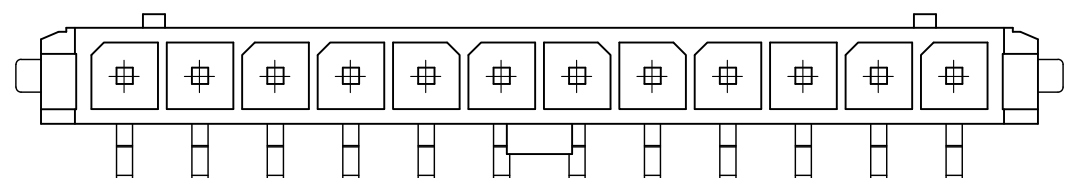

12PIN



一般公差 (TOLERANCE)  
 X ±.50 .XX ±.10  
 Y ±.20 .XXX ±.05  
 ANGLES ±1°

**ZGWD** 浙江温达电子有限公司  
 ZHEJIANG WENDA ELECTRONICS CO., LTD

品名 (TITLE) MX3.0 单排立式WTB业务图

料号 (DWG.NO) WT5557L-\*\*\*\*-\*\*

比例 (SCALE) 1:1

制图 (DR) Anlan

校对 (CHKD) 李绍宗

审核 (APPD) 黄志明

张数 (SHEET) 2 OF 2

单位 (UNITS) mm

SIZE A4

REV A

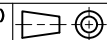

A

B

C

D

E

F

1

1

2

2

3

3

4

4

5

5