

SOD-323 Plastic-Encapsulate ESD Protection Diodes

DESCRIPTION

The SDxxC Series is designed for applications requiring transient overvoltage protection capability. They are intended for use in voltage and ESD sensitive equipment such as computers, printers, business machines, communication systems, medical equipment and other applications. These devices are ideal for situations where board space is at a premium.

This series has been specifically designed to protect sensitive components which are connected to power, data and transmission lines from overvoltage caused by ESD (electrostatic discharge), CDE (Cable Discharge Events), and EFT (electrical fast transients).

Features

- ◆ 350 Watts Peak Pulse Power per (8/20μs)
- ◆ IEC61000-4-2 (ESD) ±30kV (air), ±30kV (contact)
- ◆ IEC61000-4-4 (EFT) 40A (5/50ns)
- ◆ Protects one I/O line (bidirectional)
- ◆ Low clamping voltage
- ◆ Low leakage current
- ◆ Working voltages : 3V, 5V, 8V, 12V, 15V, 18V, 20V, 24V, 36V
- ◆ Meets MSL 1 Requirements

Pin Configuration



Circuit Diagram

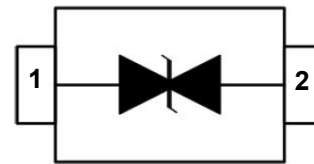

Mechanical Characteristics

- ◆ Package: SOD-323
- ◆ Flammability Rating: UL 94V-0
- ◆ Terminal: Matte tin plated.
- ◆ High temperature soldering guaranteed: 260 C /10s
- ◆ Packaging: Tape and Reel

Applications

- ◆ Cell Phone Handsets and Accessories
- ◆ Microprocessor based equipment
- ◆ Personal Digital Assistants (PDA's)
- ◆ Notebooks, Desktops, and Servers
- ◆ Portable Instrumentation
- ◆ Networking and Telecom
- ◆ Serial and Parallel Ports
- ◆ Peripherals

Absolute Maximum Ratings (T_A=25°C unless otherwise specified)

Parameter	Symbol	Value	Unit
ESD per IEC 61000-4-2 (Air)	V _{ESD}	± 30	KV
ESD per IEC 61000-4-2 (Contact)		± 30	
Peak Pulse Power (tp=8/20us waveform)	P _{PP}	350	W
Operating Temperature	T _{OPT}	-55 to +150	°C
Storage Temperature	T _{STG}	-55 to +150	°C
Lead Solder Temperature – Maximum (10 Second Duration)	T _L	260(10 sec.)	°C

The above data are for reference only.

Electrical Characteristics (T_A=25°C unless otherwise specified)

PART NUMBER	DEVICE MARKING	V _{RWM} (V) (max.)	V _B (V) (min.)	I _T (mA)	V _{C@1A} (V) (max.)	V _C (V)		I _R (μA) (max.)	C _T (pF) (max.)
						(max.)	(@A)		
SD03C	2A	3.3	4	1	7.5	16	20	40	450
SD05C	2B	5	6	1	9.8	18	17	10	300
SD08C	2C	8	8.5	1	13.4	24	15	2	120
SD12C	2D	12	13.3	1	19	32	11	1	75
SD15C	2J	15	16.7	1	24	38	10	1	68
SD18C	2K	18	20.0	1	29	45	9	1	57
SD20C	2L	20	22.3	1	35	50	8	1	52
SD24C	2H	24	26.7	1	43	52	7	1	50
SD36C	2N	36	40	1	60	75	4.5	1	35

The above data are for reference only.

ELECTRICAL CHARACTERISTICS CURVE

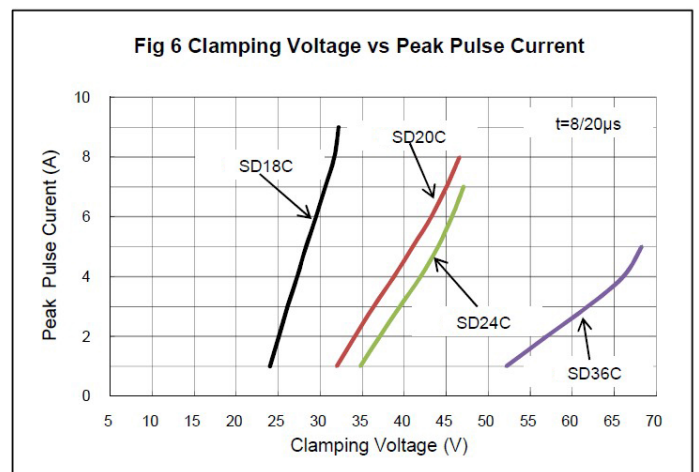
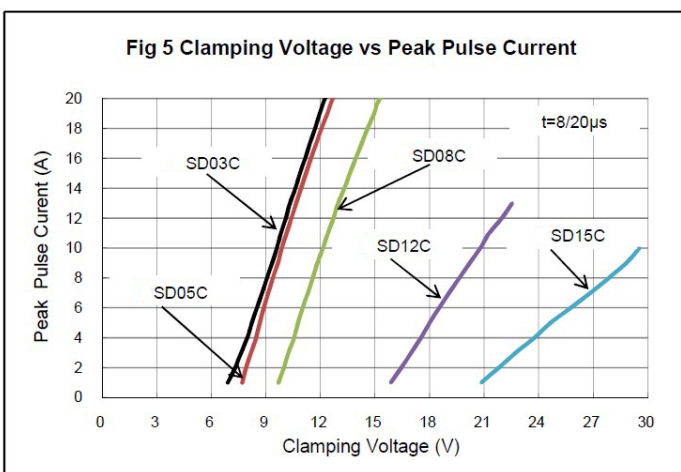
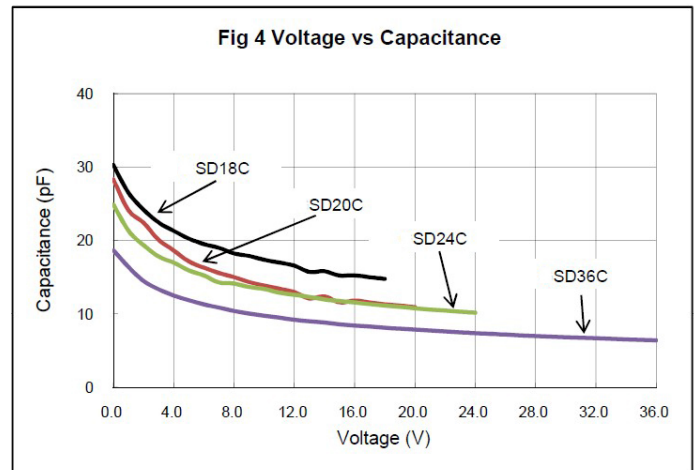
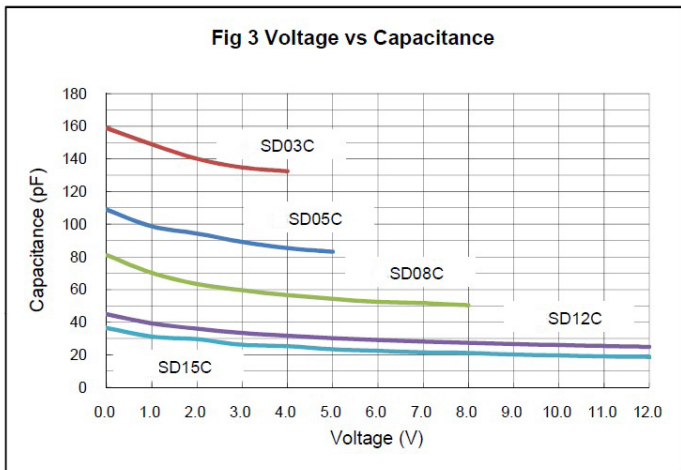
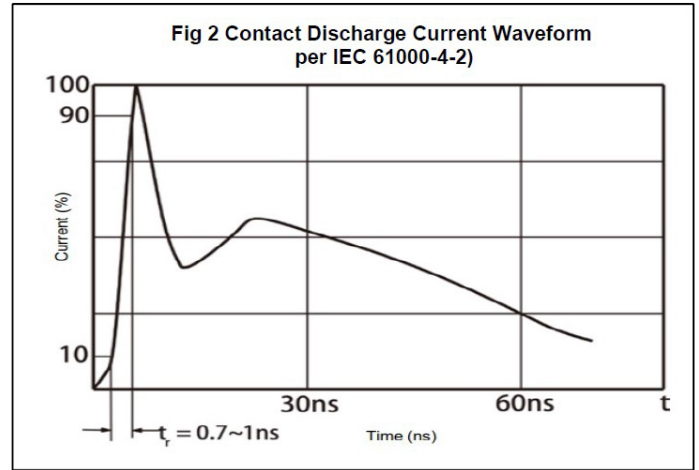
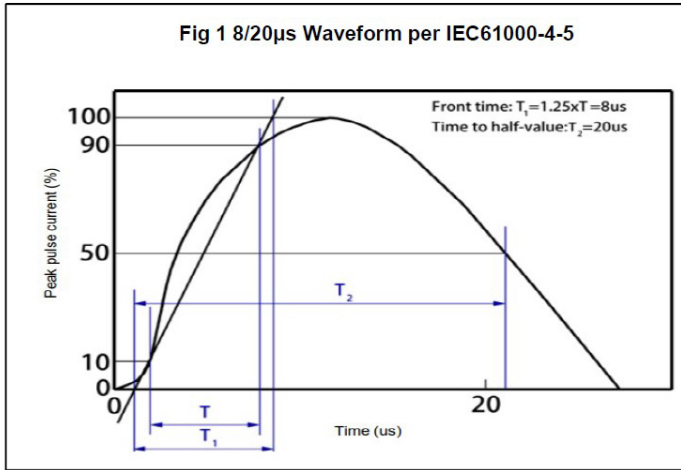

The curve above is for reference only.

Outline Drawing

SOD-323 Package Outline Dimensions

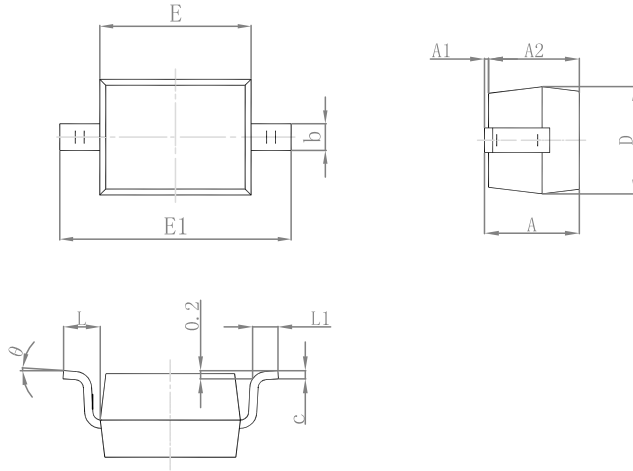

Symbol	Dimensions In Millimeters		Dimensions In Inches	
	Min.	Max.	Min.	Max.
A		1.000		0.039
A1	0.000	0.100	0.000	0.004
A2	0.800	0.900	0.031	0.035
b	0.250	0.350	0.010	0.014
c	0.080	0.150	0.003	0.006
D	1.200	1.400	0.047	0.055
E	1.600	1.800	0.063	0.071
E1	2.550	2.750	0.100	0.108
L	0.475 REF.		0.019 REF.	
L1	0.250	0.400	0.010	0.016
θ	0°		8°	

Suggested Pad Layout

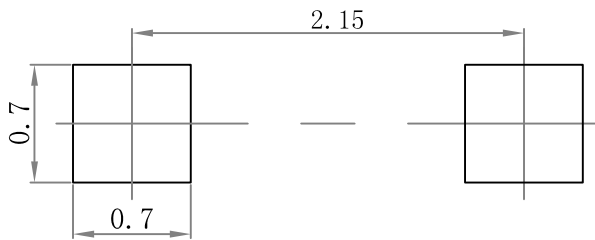

Note:

1. Controlling dimension: in/millimeters.
2. General tolerance: ±0.05mm.
3. The pad layout is for reference purposes only.

PACKAGE SPECIFICATIONS

Package	Reel Size	Reel DIA. (mm)	Q'TY/Reel (pcs)	Box Size (mm)	QTY/Box (pcs)	Carton Size (mm)	Q'TY/Carton (pcs)
SOD-323	7'	178	3000	183×188×80	45,000	386×265×215	180,000