

Features

- 1.5μA Current at no Load
- ±2% Output Accuracy
- 150mA Output Current
- Maximum working input voltage: 28V
- Package Available SOT89-3, SOT23-5, SOT23-3L

Applications

- Industrial Controls
- Home Automation
- Modules (Wireless, Camera, etc.)
- Current Limit Protection
- Portable, Battery Powered Equipment

PIN CONFIGURATION

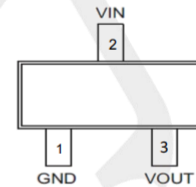
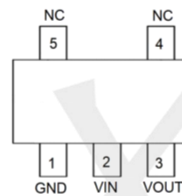
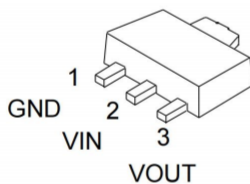

SOT89-3

SOT23-5

SOT23-3L

Pin Number			Pin Name	Pin Function
SOT89-3	SOT23-5	SOT23-3L		
1	1	1	GND(VSS)	Ground
2	2	2	VIN	Input of Supply Voltage
3	3	3	VOUT	Output of the Regulator
--	4,5	--	NC	No Internal Connection

Ordering Information

HT75XXXX

PACKAGE TYPE

-1: SOT89-3

S: SOT23-3L

S-2: SOT23-5

OUTPUT VOLTAGE

Example: HT7533-1

→ 3.3V Version, in SOT89-3 Package & Tape & Reel Packing Type

30: 3.0V

33: 3.3V

36: 3.6V

40: 4.0V

44: 4.4V

50: 5.0V

A2: 12V

XX: X.XV

Absolute Maximum Ratings

over operating free-air temperature range (unless otherwise noted)

		MIN	MAX	UNIT
VIN	Input voltage range	-0.3	28	V
IOUT	Output pin current	Internally limited		mA
Temperature	Operating junction, T _J	-25	85	°C
	Storage, T _{stg}	-40	125	

BLOCK DIAGRAM

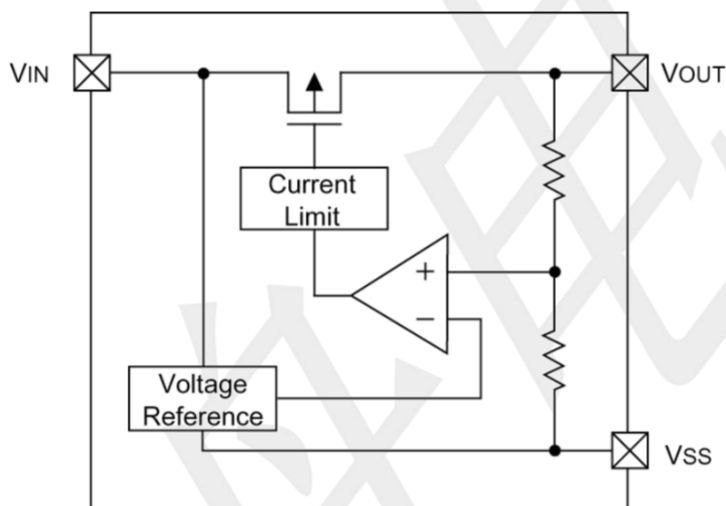

Typical Application Circuit

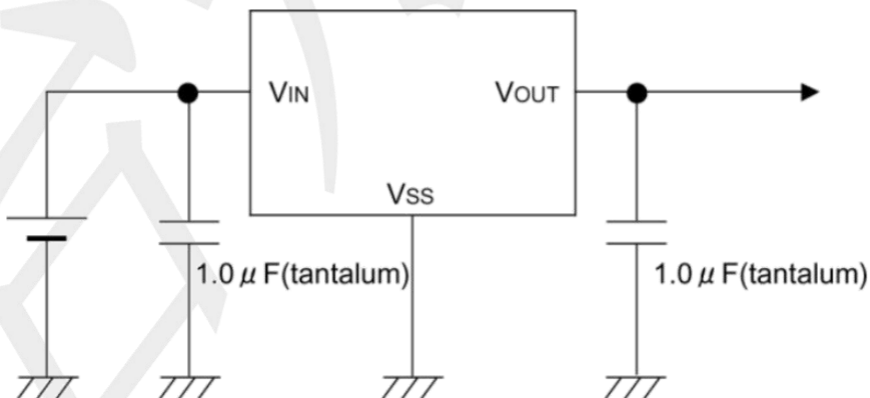

Electrical Characteristics

(VIN=15V, VEN=5V, TA=25°C, unless otherwise specified)

PARAMETER	SYMBOL	TEST Conditions	MIN	TYP	MAX	UNIT
Supply Voltage	VIN		2.7	--	24	V
Output current	IOUT		150	--	--	mA
DC Output Voltage Accuracy		IOUT = 0.1mA	-2	--	2	%
Dropout Voltage (VIN-VOUT)	IOUT = 100mA	VOUT = 3.0V	--	530	--	mV
		VOUT = 3.3V	--	520	--	
		VOUT = 3.6V	--	500	--	
		VOUT = 5.0V	--	420	--	
Ground Current (IOUT = 0mA)	IQ	VOUT = 3.3V	--	1.5	4.0	uA
Line Regulation	ΔLINE	IOUT = 1mA, 3 ≤ VIN ≤ 24V	--	0.3	--	%
Load Regulation	ΔLOAD	10mA ≤ IOUT ≤ 100mA	--	0.3	--	
Output Current Limit	ILIM	VOUT = 0.9 × VOUT(NOM)	170	200	--	mA
Power Supply Rejection Ratio	PSRR	VOUT = 3.3V, IOUT = 30mA, VIN = 12V, f = 1kHz	--	68	--	dB
Package Thermal Resistance θJA (Note 1)	SOT23-5	Thermal Resistance Junction-to Ambient	--	210	--	°C/W
	SOT23-3L		--	210	--	
	SOT89-3		--	120	--	
Total Power Dissipation Tc=25°C	SOT23-5	PDTOT	--	0.3	--	W
	SOT23-3L		--	0.3	--	
	SOT89-3		--	0.5	--	

Note: 1. Test condition: the device is mounted on FR-4 substrate PC board, with minimum recommended pad layout.

Typical Operating Characteristics (25 °C, unless otherwise noted)

Line-Transient Response

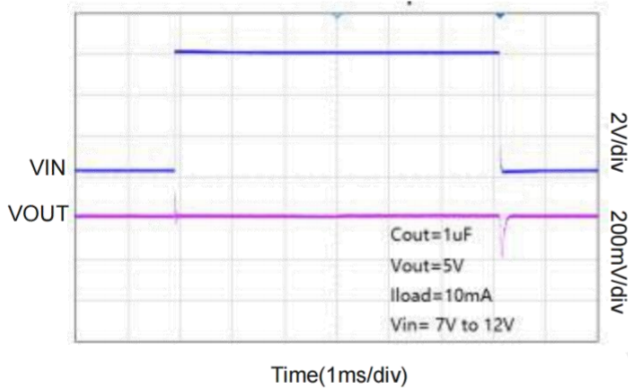

Line-Transient Response

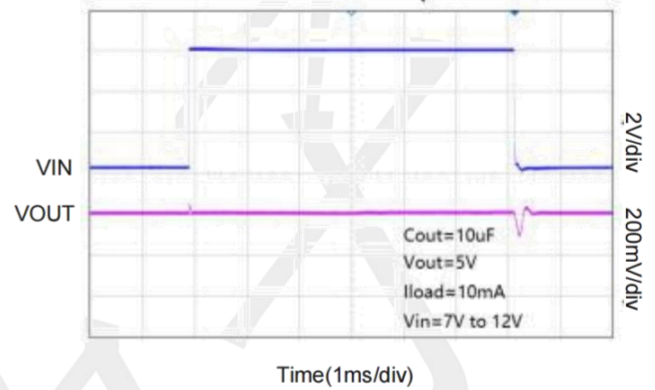

Load-Transient Response

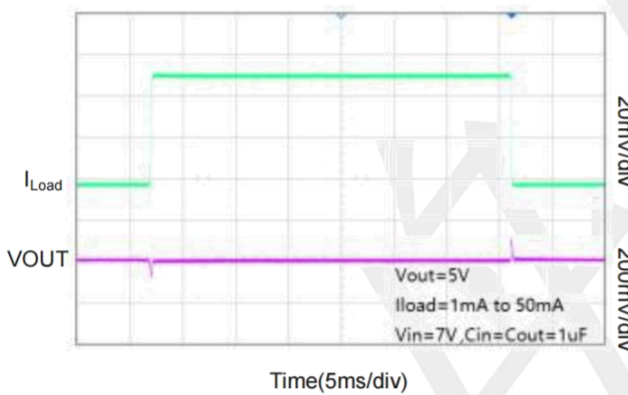

Load-Transient Response

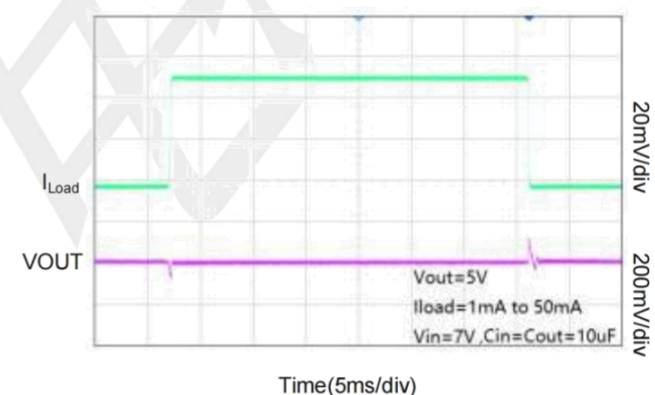

Start up Response



Start up Response

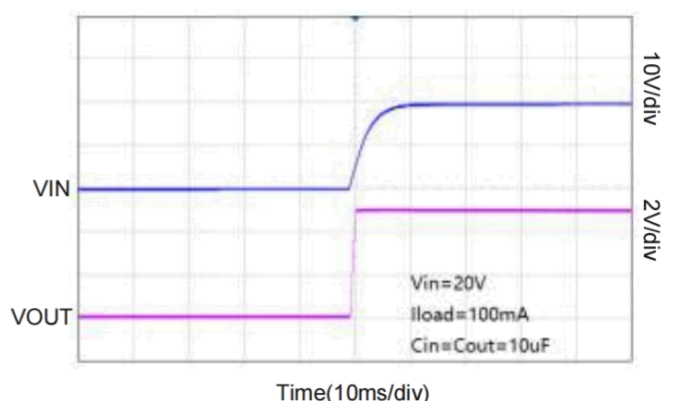

Package information

SOT23-5(unit:mm)

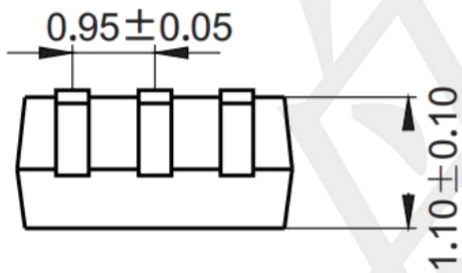
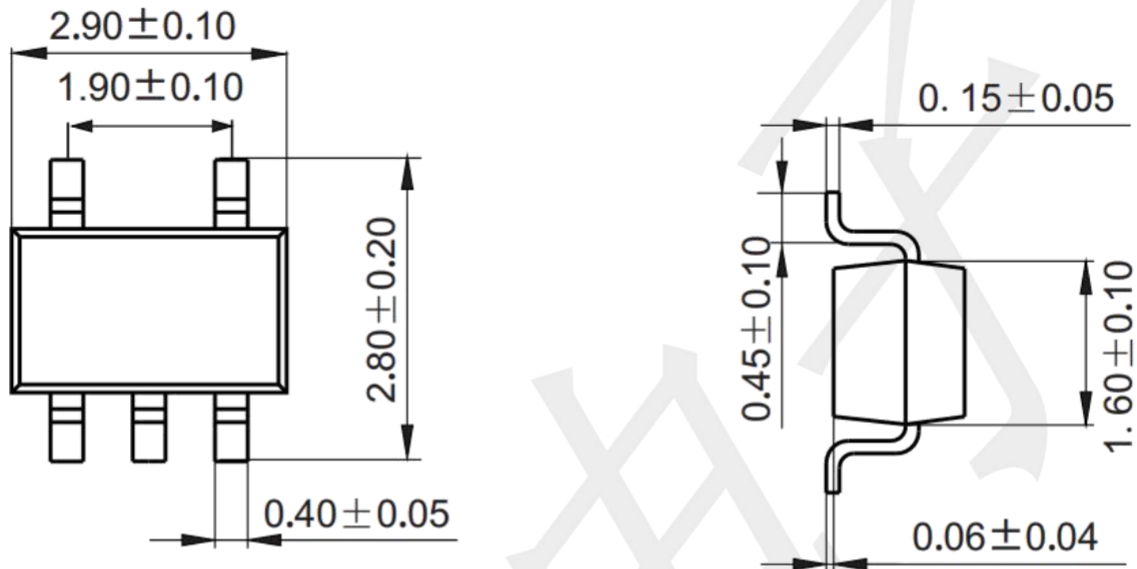

Mounting Pad Layout (unit: mm)

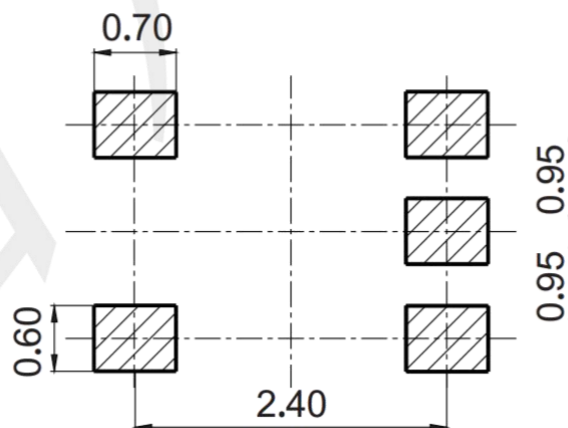

Package information

SOT23-3L(unit:mm)

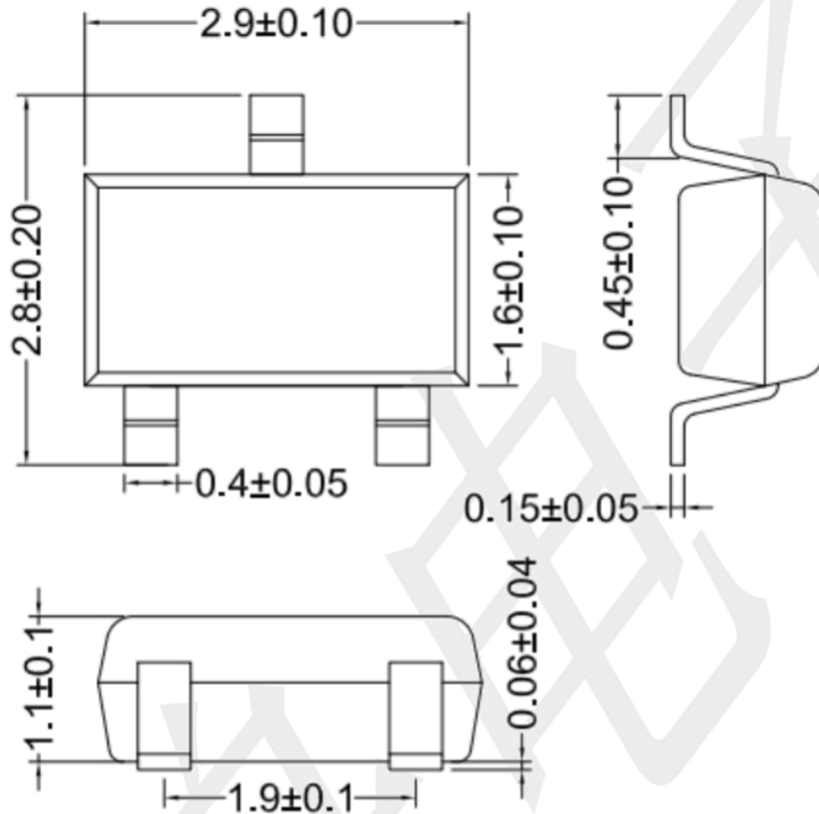

Mounting Pad Layout (unit: mm)

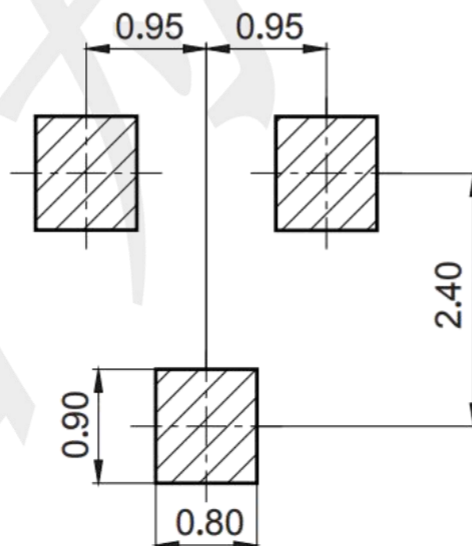

Package information

SOT89-3(unit:mm)

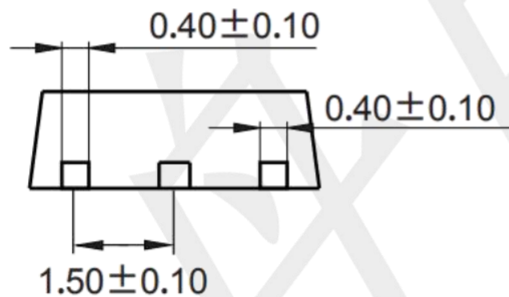
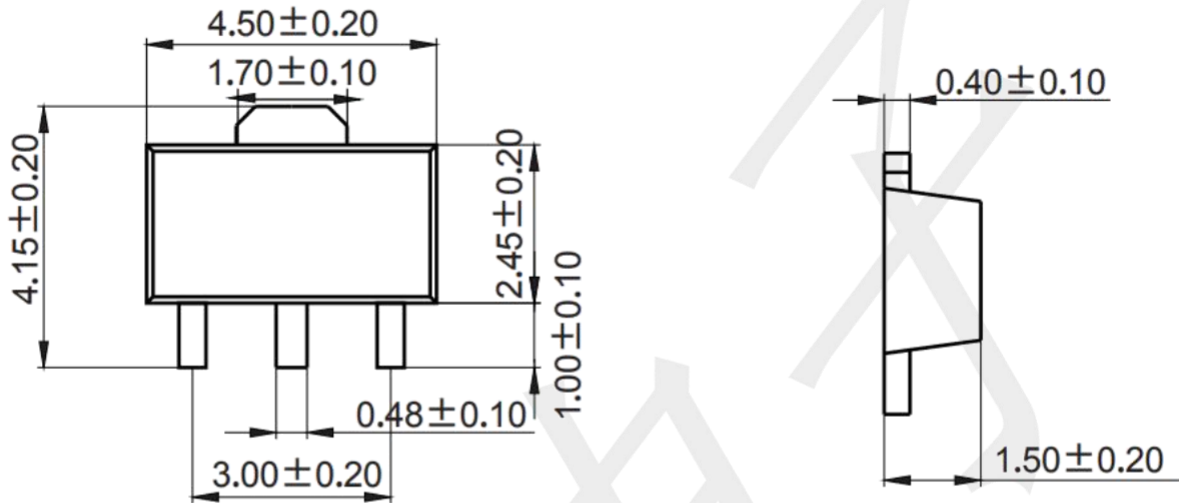

Mounting Pad Layout (unit: mm)

