

LDO Regulators with Voltage Detector

500 mA Output LDO Regulator with Voltage Detector

BD42754FP2-C BD42754FPJ-C

General Description

BD42754FP2-C, BD42754FPJ-C are voltage regulators featuring 45 V absolute maximum voltage with 1ch Reset and offers the output current of 500 mA while limiting the low quiescent current. These regulators are therefore ideal for applications requiring a direct connection to the battery and a low current consumption. A reset signal is generated for an output voltage V_O of Typ 4.62 V. The reset delay time can be programmed by the external capacitor.

Features

- Low ESR Ceramic Capacitors Applicable for Output.
- Low Drop Voltage: PDMOS Output Transistor
- Power On and Under-Voltage Reset
- Programmable Reset Time by External Capacitor.

Applications

- Onboard vehicle device (Engine ECU, Body-Control, Car Stereos, Satellite Navigation system, etc.)

Key Specifications

- AEC-Q100 qualified^(Note 1)
 - Qualified for Automotive Applications
 - Input Voltage Range: -0.3V to +45V
 - Low Quiescent Current: 75 μ A (Typ)
 - Output Load Current: 500 mA (Max)
 - Output Voltage: 5.0 V \pm 2 %
 - Reset Detect Voltage Accuracy: 4.50 V to 4.75 V (Typ 4.62 V)
 - Over Current Protection (OCP)
 - Thermal Shut Down (TSD)
- (Note 1:Grade1)

Package

FP2: TO263-5 **W (Typ) × D (Typ) × H (Max)**
10.16 mm × 15.10 mm × 4.70 mm



FPJ: TO252-J5 6.60 mm × 10.10 mm × 2.38 mm



Figure 1. Package image

Typical Application Circuit

- VCC and VO pin capacitors: $0.1 \mu\text{F} \leq C_{IN}$ (Typ), $6 \mu\text{F} \leq C_O$ (Min)
Please refer to the "Selection of Components Externally Connected" for the selection of VCC and VO capacitors.

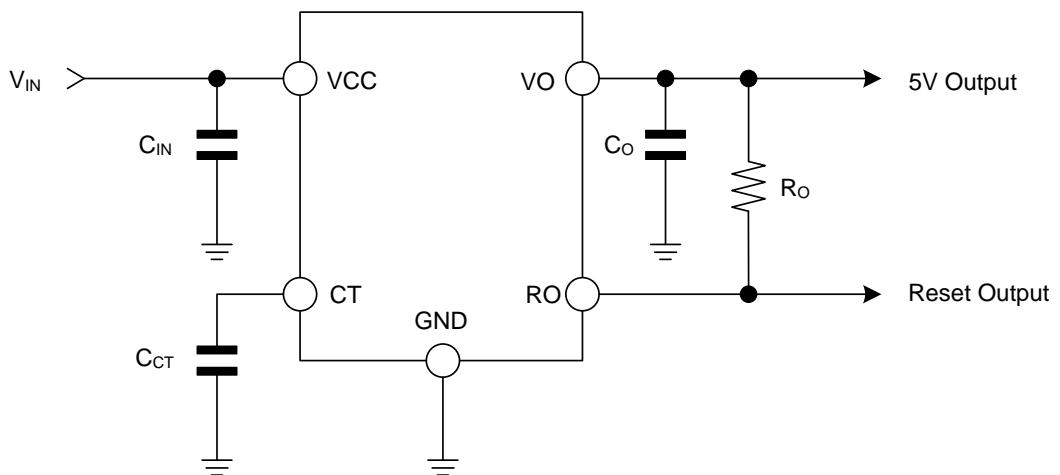

Figure 2. Application Circuit

Pin Configurations

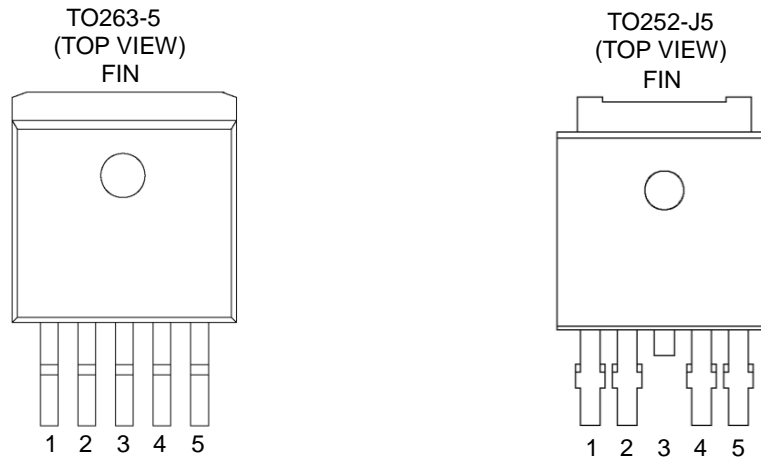

Figure 3. Pin Configuration

Pin Descriptions

Pin No.	Pin Name	Function
1	VCC	Supply Voltage Input
2	RO	Reset Output; Open-Collector output.
3	GND	Ground; Pin3 internally connected to FIN.
4	CT	Reset Delay; connect capacitor to GND for setting delay time.
5	VO	5V Output;
FIN	FIN	FIN; FIN internally connected to Pin3.

Block Diagram

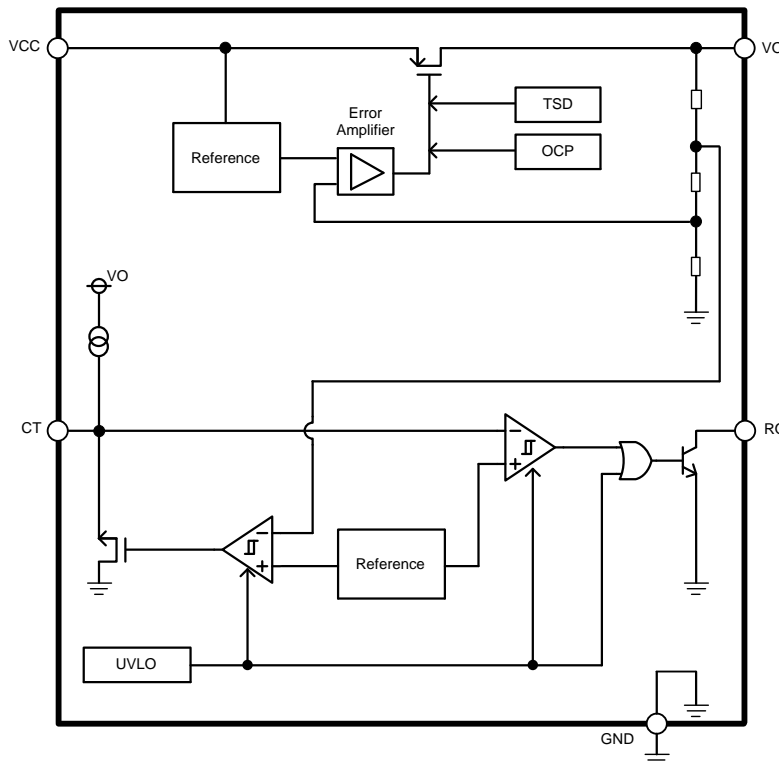

Figure 4. Block Diagram

Block Descriptions

Block Name	Function	Description of Blocks
Reference	Reference Voltage	The Reference generates the Reference Voltage.
Error Amplifier	Error Amplifier	The Error Amplifier amplifies the difference between the feed back voltage of the output voltage and the reference voltage.
TSD	Thermal Shutdown	The TSD protects the device from overheating. If the chip temperature (Tj) reaches ca. 175 °C (Typ), the output is turned off.
OCP	Over Current Protection	The OCP protects the device from damage caused by over current.
UVLO	Under Voltage Lock Out	The UVLO prevents malfunction of the reset block in case of very low output voltage which is supply voltage of the reset.

Absolute Maximum Ratings

Parameter	Symbol	Limits	Unit
VCC Voltage	V_{CC}	-0.3 to +45.0	V
RO Voltage	V_{RO}	-0.3 to +18.0	V
VO Voltage	V_O	-0.3 to +7.0	V
Junction Temperature Range	T_j	-40 to +150	°C
Storage Temperature Range	T_{stg}	-55 to +150	°C

(Caution) Exceeding the absolute maximum rating for supply voltage, operating temperature or other parameters can result in damages to or destruction of the chip. In this event it also becomes impossible to determine the cause of the damage (e.g. short circuit, open circuit, etc.). Therefore, if any special mode is being considered with values expected to exceed the absolute maximum ratings, implementing physical safety measures, such as adding fuses, should be considered.

Recommended Operating Conditions

Parameter	Symbol	Min	Max	Unit
Supply Voltage ($I_o \leq 300\text{mA}$)	V_{CC}	5.5	45.0	V
Supply Voltage ($I_o \leq 500\text{mA}$)	V_{CC}	5.9	45.0	V
Start-Up Voltage ^(Note 1)	V_{CC}	3.0	-	V
Output Current	I_o	0	500	mA
Operating Ratings Temperature	T_a	-40	125	°C

(Note 1) When $I_o=0\text{mA}$.

Thermal Resistance^(Note 1)

Parameter	Symbol	Thermal Resistance (Typ)		Unit
		1s ^(Note 3)	2s2p ^(Note 4)	
TO263-5				
Junction to Ambient	θ_{JA}	80.7	20.3	°C/W
Junction to Top Characterization Parameter ^(Note 2)	Ψ_{JT}	8	2	°C/W
TO252-J5				
Junction to Ambient	θ_{JA}	136	23	°C/W
Junction to Top Characterization Parameter ^(Note 2)	Ψ_{JT}	17	3	°C/W

(Note 1)Based on JESD51-2A(Still-Air)

(Note 2)The thermal characterization parameter to report the difference between junction temperature and the temperature at the top center of the outside surface of the component package.

(Note 3)Using a PCB board based on JESD51-3.

Layer Number of Measurement Board	Material	Board Size
Single	FR-4	114.3mm x 76.2mm x 1.57mmt
Top		
Copper Pattern	Thickness	
Footprints and Traces	70μm	

(Note 4)Using a PCB board based on JESD51-5, 7.

Layer Number of Measurement Board	Material	Board Size	Thermal Via ^(Note 5)		
			Pitch	Diameter	
4 Layers	FR-4	114.3mm x 76.2mm x 1.6mmt	1.20mm	Φ0.30mm	
Top		2 Internal Layers		Bottom	
Copper Pattern	Thickness	Copper Pattern	Thickness	Copper Pattern	Thickness
Footprints and Traces	70μm	74.2mm x 74.2mm	35μm	74.2mm x 74.2mm	70μm

(Note 5) This thermal via connects with the copper pattern of all layers. The placement and dimensions obey a land pattern.

Electrical Characteristics (LDO)(Unless Otherwise Specified, $T_j = -40\text{ }^\circ\text{C}$ to $+150\text{ }^\circ\text{C}$, $V_{CC} = 13.5\text{ V}$, $I_o = 0\text{ mA}$, Typ is the value when $T_j = 25\text{ }^\circ\text{C}$)

Parameter	Symbol	Limits			Unit	Conditions
		Min	Typ	Max		
Circuit Current	I_{CC}	-	75	150	μA	$I_o = 0\text{ mA}$
Output Voltage 1	V_o	4.90	5.00	5.10	V	$5\text{ mA} \leq I_o \leq 400\text{ mA}$ $6\text{ V} \leq V_{CC} \leq 28\text{ V}$
Output Voltage 2	V_o	4.90	5.00	5.10	V	$5\text{ mA} \leq I_o \leq 200\text{ mA}$ $6\text{ V} \leq V_{CC} \leq 40\text{ V}$
Dropout Voltage	ΔV_d	-	0.25	0.5	V	$V_{CC} = 4.75\text{ V}$, $I_o = 300\text{ mA}$
Load Regulation	Reg.L	-	10	30	mV	$I_o = 10\text{ mA}$ to 250 mA
Line Regulation	Reg.l	-15	-	15	mV	$V_{CC} = 8\text{ V}$ to 16 V , $I_o = 5\text{ mA}$
Current Limit	I_{OCP}	500	-	-	mA	
Ripple Rejection	R.R.	-	60	-	dB	$f = 120\text{ Hz}$, $e_{in} = 1\text{ V}_{rms}$, $I_o = 100\text{ mA}$
Thermal Shutdown Temperature	T_{TSD}	-	175	-	$^\circ\text{C}$	

Electrical Characteristics (RESET)(Unless Otherwise Specified, $T_j = -40\text{ }^\circ\text{C}$ to $+150\text{ }^\circ\text{C}$, $V_{CC} = 13.5\text{ V}$, $I_o = 0\text{ mA}$, Typ is the value when $T_j = 25\text{ }^\circ\text{C}$)

Parameter	Symbol	Limits			Unit	Conditions
		Min	Typ	Max		
Reset Detection Threshold	V_{RT}	4.50	4.62	4.75	V	
Reset Detection Hysteresis	V_{RHYS}	20	60	100	mV	
CT Upper-side Threshold	V_{CTH}	-	1.18	-	V	
CT Lower-side Threshold	V_{CTL}	-	0.25	-	V	
CT Charge Current	I_{CT}	-	8.8	-	μA	$V_{CT} = 0.5\text{ V}$
Delay Time L→H	t_{POR}	10	14	18	ms	$C_{CT} = 0.1\text{ }\mu\text{F}$ ^(Note 1)
RO L Voltage	V_{ROL}	-	-	0.4	V	RO pull-up resistor $\geq 4.7\text{ k}\Omega$ $V_o \geq 1\text{ V}$

(Note 1) T_{POR} can be varied by changing the CT capacitance value(T_{POR_ADJ}). ($0.001\mu\text{F}$ to $10\text{ }\mu\text{F}$ available) $T_{POR_ADJ}(\text{ms}) \approx T_{POR}(\text{ the reset delay time at } C_{CT} = 0.1\text{ }\mu\text{F}) \times C_{CT}(\mu\text{F}) / 0.1$ CT capacitor : $0.1\mu\text{F} \leq C_{CT} \leq 10\text{ }\mu\text{F}$ example: When $C_{CT} = 1\mu\text{F}$, $100\text{ms} \leq T_{POR} \leq 180\text{ ms}$ $T_{POR_ADJ}(\text{ms}) \approx T_{POR}(\text{ the reset delay time at } C_{CT} = 0.1\text{ }\mu\text{F}) \times C_{CT}(\mu\text{F}) / 0.1 \pm 0.1$ CT capacitor : $0.001\mu\text{F} \leq C_{CT} < 0.1\text{ }\mu\text{F}$ example: When $C_{CT} = 0.01\mu\text{F}$, $0.9\text{ms} \leq T_{POR} \leq 1.9\text{ ms}$

Typical Performance Curve (Unless Otherwise Specified, $T_j = 25\text{ }^\circ\text{C}$, $V_{CC} = 13.5\text{ V}$)

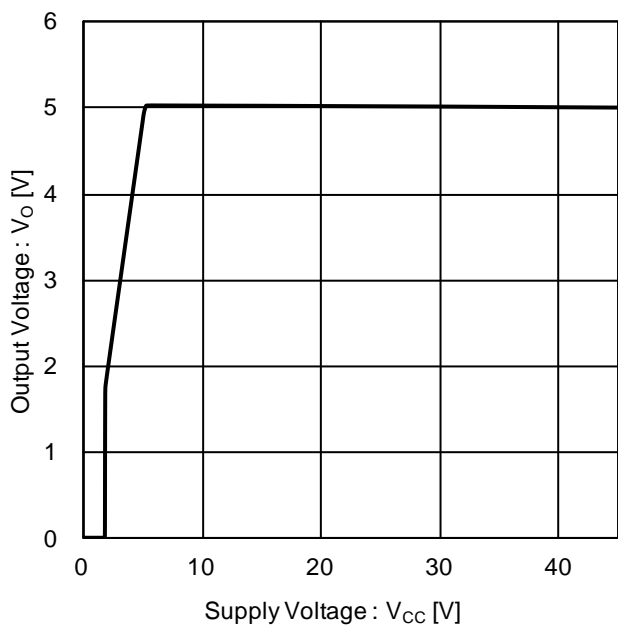

Figure 5. Output Voltage vs Supply Voltage ($R_L = 25\ \Omega$)

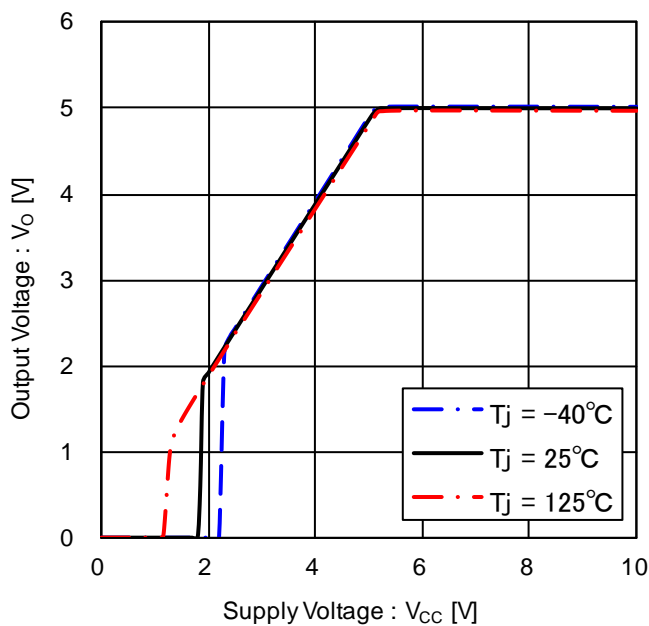

Figure 6. Output Voltage vs Supply Voltage (at Low Supply Voltage, $R_L = 25\ \Omega$)

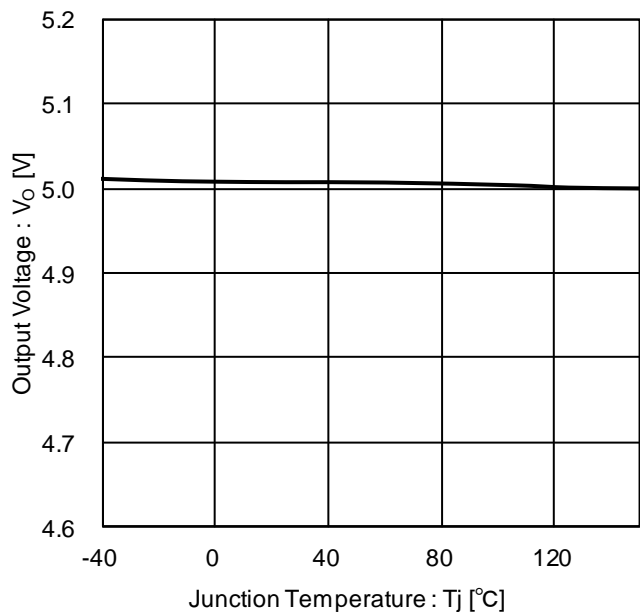

Figure 7. Output Voltage vs Temperature ($R_L = 1\ \text{k}\Omega$)

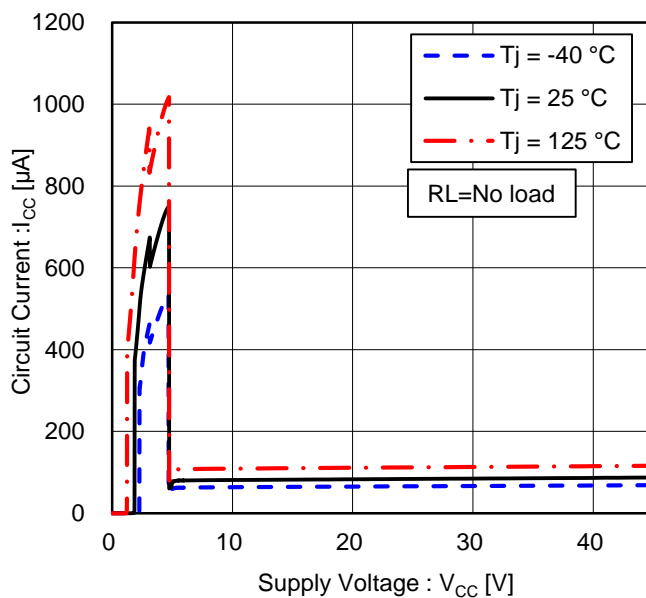

Figure 8. Circuit Current vs Supply Voltage

Typical Performance Curve - continued

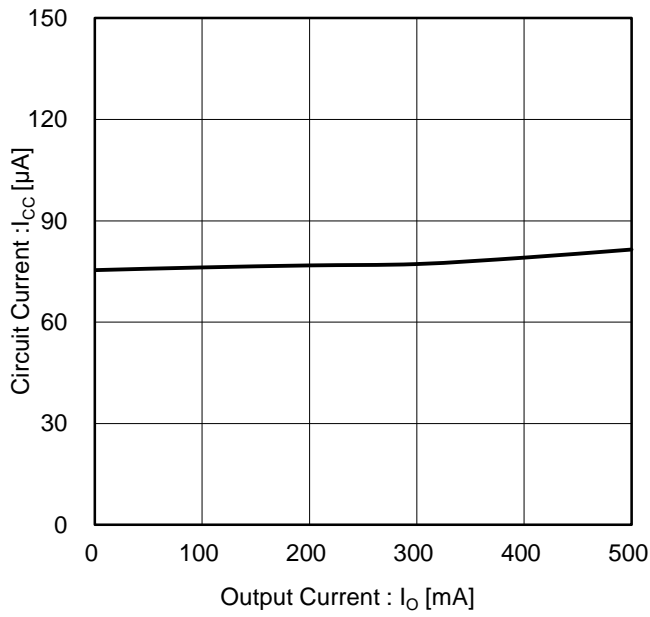

Figure 9. Circuit Current vs Output Current

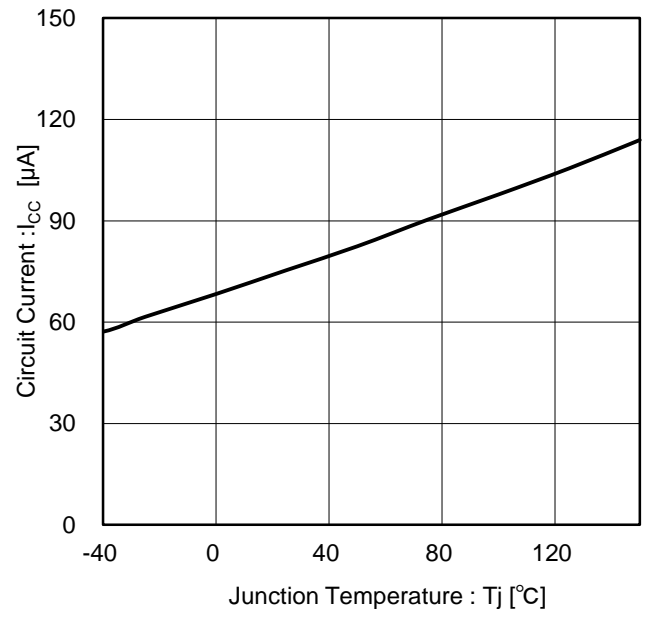

Figure 10. Circuit Current vs Temperature

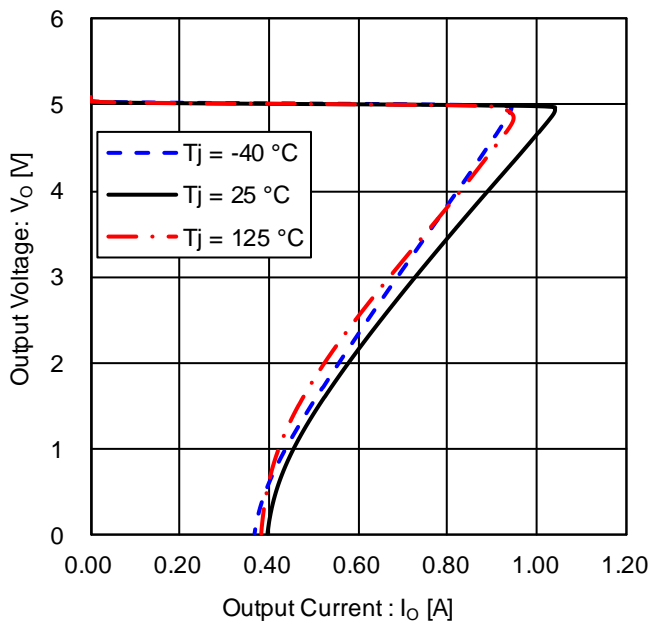

Figure 11. Output Voltage vs Output Current (Over Current Protection)

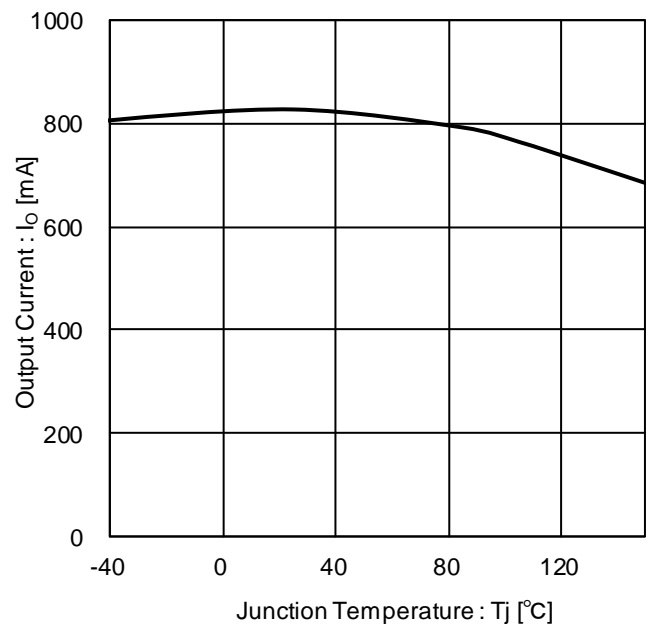

Figure 12. Output Current vs Temperature

Typical Performance Curve - continued

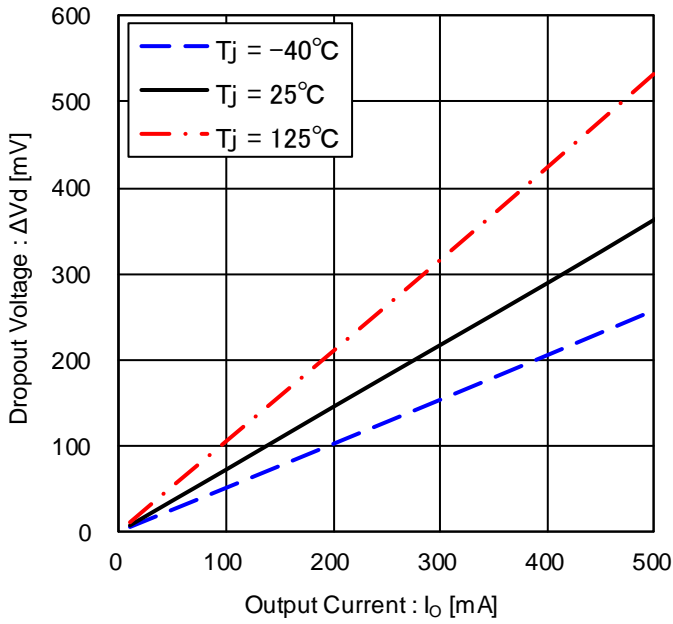

Figure 13. Dropout Voltage vs Output Current (V_{CC} = 4.75 V)

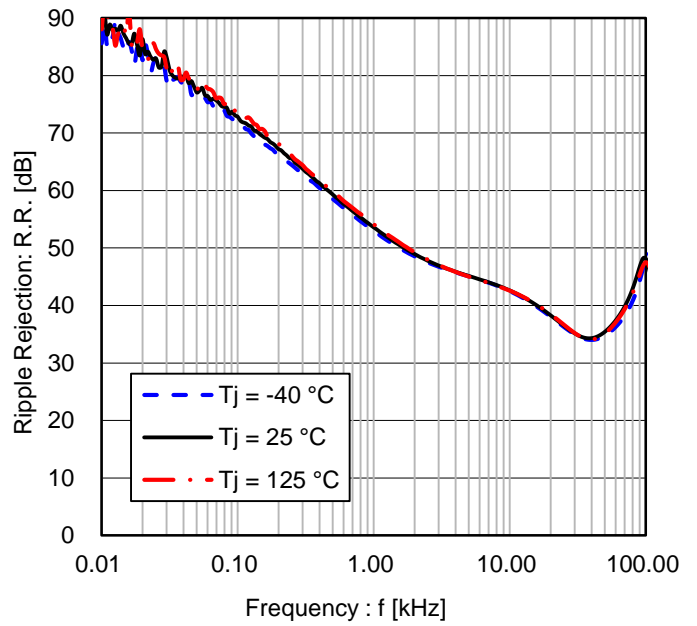

Figure 14. Ripple Rejection (e_{in}=1V_{rms}, I_{OUT}=100mA)

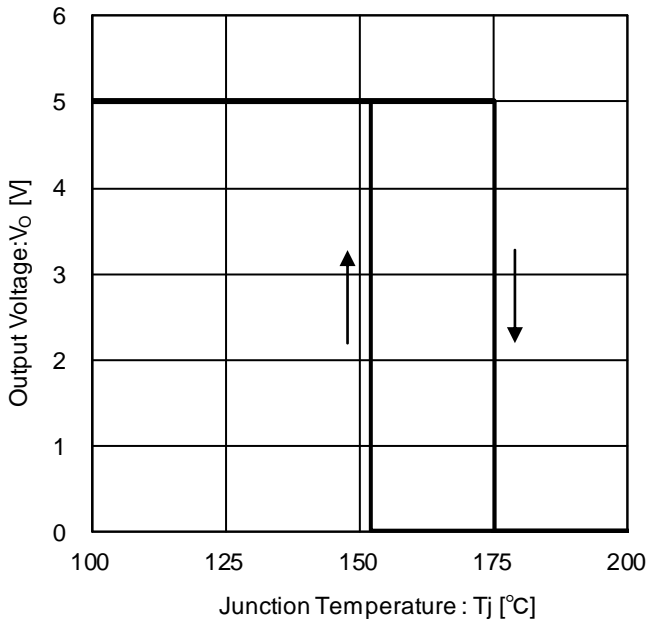

Figure 15. Output Voltage vs Temperature (Thermal Shutdown)

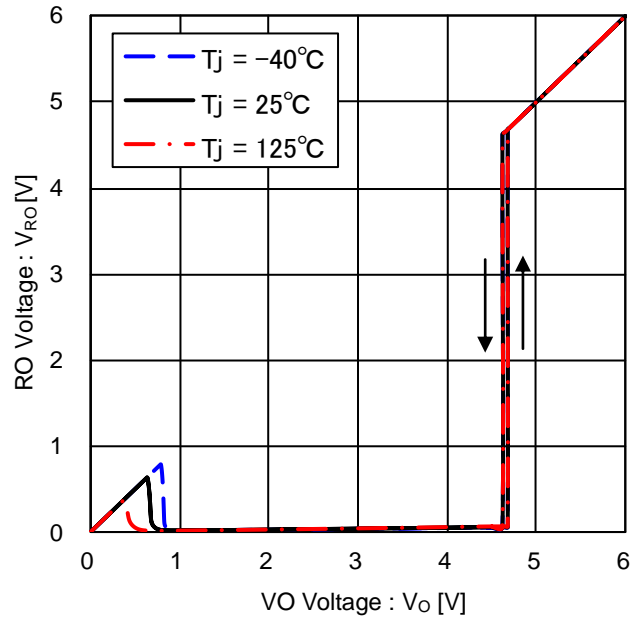

Figure 16. RO Voltage vs VO Voltage (RO: 10 kΩ pull-up to VO)

Typical Performance Curve - continued

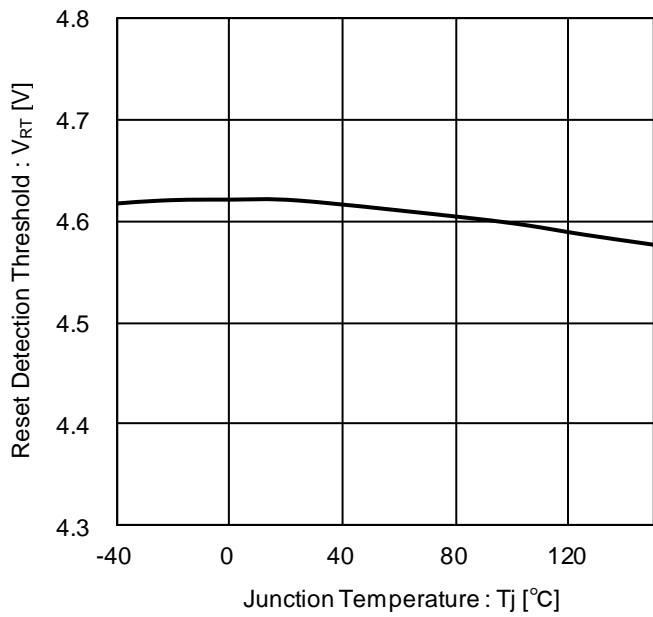

Figure 17. Reset Detection Threshold vs Temperature (RO: 10 kΩ pull-up to VO)

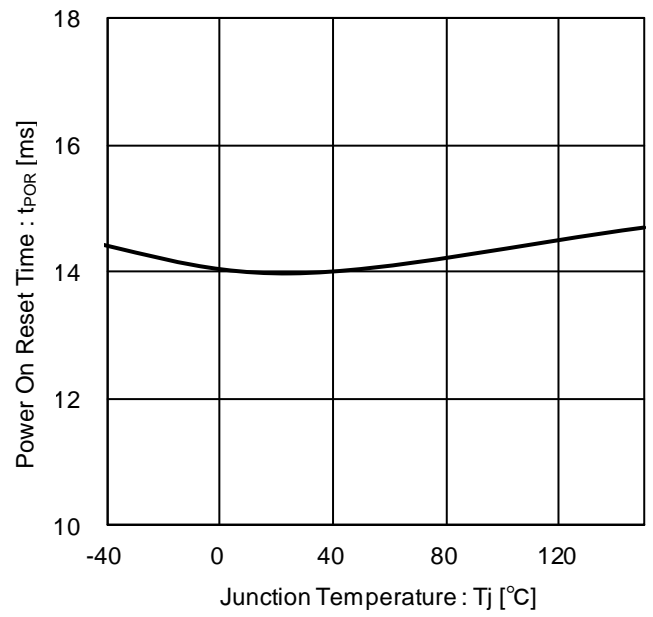

Figure 18. Power on Reset Time vs Temperature (C_{CT} = 0.1 μF)

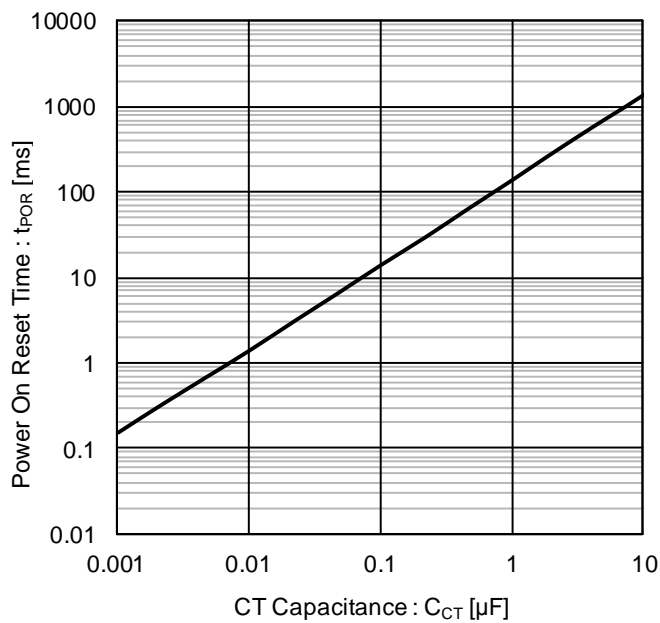
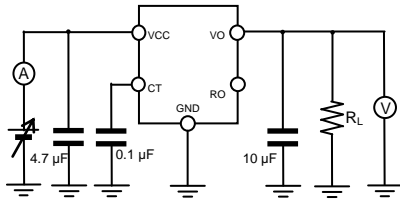
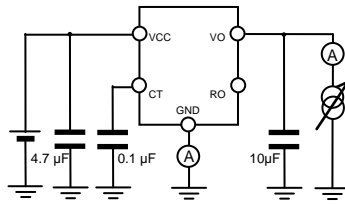

Figure 19. Power on Reset Time vs CT Capacitance

Measurement Circuit for Typical Performance Curve



Measurement Circuit for Figure. 5, 6, 7, 8, 10, 15



Measurement Circuit for Figure.9

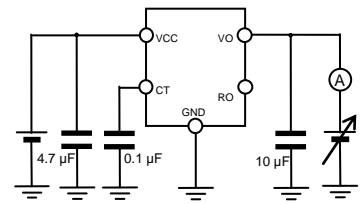

Measurement Circuit for Figure.11, 12

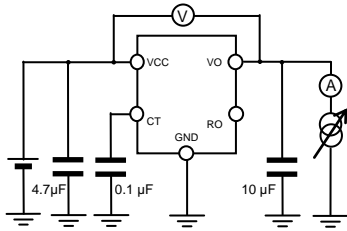

Measurement Circuit for Figure.13

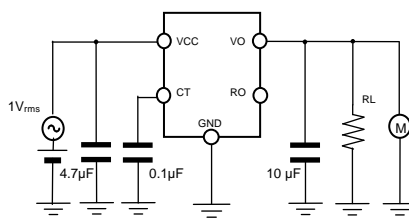

Measurement Circuit for Figure.14

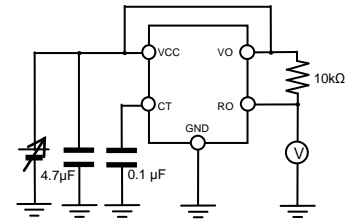

Measurement Circuit for Figure.16, 17

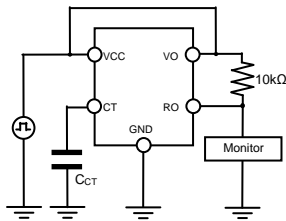

Measurement Circuit for Figure.18, 19

Figure 20. Measurement Circuit for Typical Performance Curves

Timing Chart

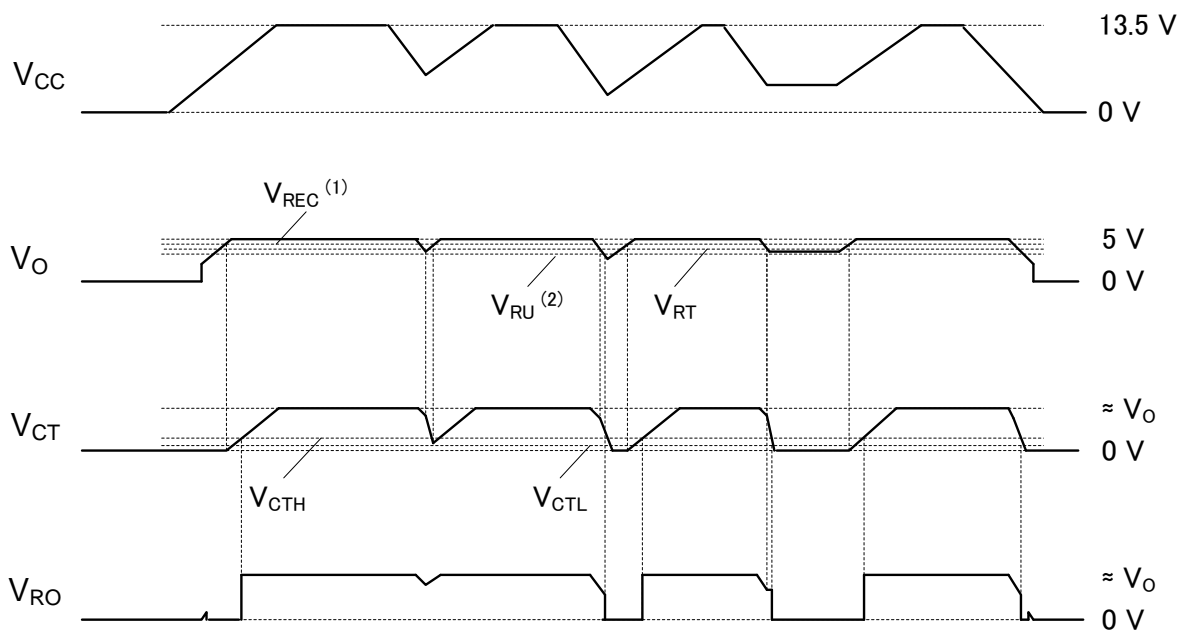

Figure 21. Timing Chart

(1) $V_{REC} = V_{RT} + V_{RHV}$
 (2) $V_{RU} = 2V \text{ to } 3.5V$

Power Dissipation

■ TO263-5

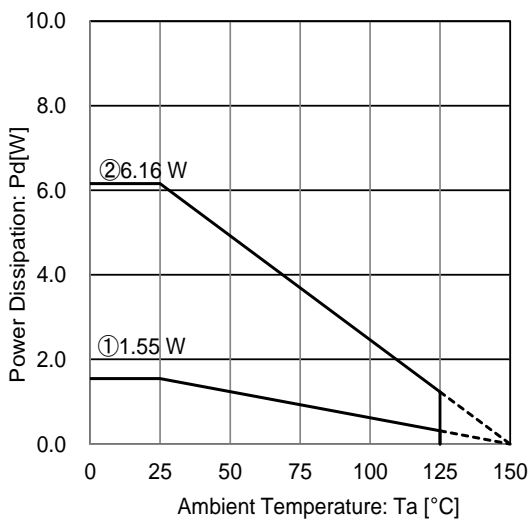

Figure 22. TO263-5 Package Data

IC mounted on ROHM standard board based on JEDEC.

①: 1-layer PCB (Copper foil area on the reverse side of PCB: 0 mm × 0 mm)

Board material: FR4

Board size: 114.3mm × 76.2mm × 1.57 mmt

Mount condition: PCB and exposed pad are soldered.

Top copper foil: ROHM recommended footprint + wiring to measure, 2 oz. copper.

②: 4-layer PCB

(Copper foil area on the reverse side of PCB: 74.2 mm × 74.2 mm)

Board material: FR4

Board size: 114.3mm × 76.2mm × 1.60 mmt

Mount condition: PCB and exposed pad are soldered.

Top copper foil: ROHM recommended footprint + wiring to measure, 2 oz. copper.

2 inner layers copper foil area of PCB: 74.2 mm × 74.2 mm, 1 oz. copper.

Copper foil area on the reverse side of PCB: 74.2 mm × 74.2 mm, 2 oz. copper.

Condition①: $\theta_{JA} = 80.7 \text{ }^\circ\text{C/W}$, Ψ_{JT} (top center) = 8 °C/W

Condition②: $\theta_{JA} = 20.3 \text{ }^\circ\text{C/W}$, Ψ_{JT} (top center) = 2 °C/W

■ TO252-J5

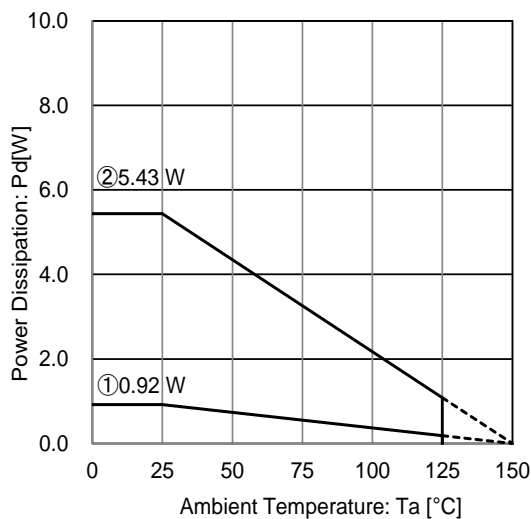

Figure 23. TO252-J5 Package Data

IC mounted on ROHM standard board based on JEDEC.

①: 1-layer PCB (Copper foil area on the reverse side of PCB: 0 mm × 0 mm)

Board material: FR4

Board size: 114.3mm × 76.2mm × 1.57 mmt

Mount condition: PCB and exposed pad are soldered.

Top copper foil: ROHM recommended footprint + wiring to measure, 2 oz. copper.

②: 4-layer PCB

(Copper foil area on the reverse side of PCB: 74.2 mm × 74.2 mm)

Board material: FR4

Board size: 114.3mm × 76.2mm × 1.60 mmt

Mount condition: PCB and exposed pad are soldered.

Top copper foil: ROHM recommended footprint + wiring to measure, 2 oz. copper.

2 inner layers copper foil area of PCB: 74.2 mm × 74.2 mm, 1 oz. copper.

Copper foil area on the reverse side of PCB: 74.2 mm × 74.2 mm, 2 oz. copper.

Condition①: $\theta_{JA} = 136 \text{ }^\circ\text{C/W}$, Ψ_{JT} (top center) = 17 °C/W

Condition②: $\theta_{JA} = 23 \text{ }^\circ\text{C/W}$, Ψ_{JT} (top center) = 3 °C/W

Thermal Design

This product exposes a frame on the back side of the package for thermal efficiency improvement. Within this IC, the power consumption is decided by the dropout voltage condition, the load current and the circuit current. Refer to power dissipation curves illustrated in Figure 22, 23 when using the IC in an environment of $T_a \geq 25\text{ }^\circ\text{C}$. Even if the ambient temperature T_a is at $25\text{ }^\circ\text{C}$, depending on the input voltage and the load current, chip junction temperature can be very high. Consider the design to be $T_j \leq T_{jmax} = 150\text{ }^\circ\text{C}$ in all possible operating temperature range. Should by any condition the maximum junction temperature $T_{jmax} = 150\text{ }^\circ\text{C}$ rating be exceeded by the temperature increase of the chip, it may result in deterioration of the properties of the chip. The thermal impedance in this specification is based on recommended PCB and measurement condition by JEDEC standard. Verify the application and allow sufficient margins in the thermal design by the following method is used to calculate the junction temperature T_j . T_j can be calculated by either of the two following methods.

1. The following method is used to calculate the junction temperature T_j from ambient temperature T_a .

$$T_j = T_a + P_C \times \theta_{JA}$$

T_j : Junction Temperature
 T_a : Ambient Temperature
 P_C : Power Consumption
 θ_{JA} : Thermal Impedance
 (Junction to Ambient)

2. The following method is also used to calculate the junction temperature T_j from Top Center of Case's (mold) Temperature T_T .

$$T_j = T_T + P_C \times \Psi_{JT}$$

T_j : Junction Temperature
 T_T : Top Center of Case's (mold) Temperature
 P_C : Power consumption
 Ψ_{JT} : Thermal Impedance
 (Junction to Top Center of Case)

The following method is used to calculate the power consumption P_C (W).

$$P_C = (V_{CC} - V_O) \times I_O + V_{CC} \times I_{CC}$$

P_C : Power Consumption
 V_{CC} : Input Voltage
 V_O : Output Voltage
 I_O : Load Current
 I_{CC} : Circuit Current

· **Calculation Example (TO263-5)**

If $V_{CC} = 13.5 \text{ V}$, $V_O = 5.0 \text{ V}$, $I_O = 200 \text{ mA}$, $I_{CC} = 75 \text{ }\mu\text{A}$, the power consumption P_C can be calculated as follows:

$$\begin{aligned} P_C &= (V_{CC} - V_O) \times I_O + V_{CC} \times I_{CC} \\ &= (13.5 \text{ V} - 5.0 \text{ V}) \times 200 \text{ mA} + 13.5 \text{ V} \times 75 \text{ }\mu\text{A} \\ &= 1.7 \text{ W} \end{aligned}$$

At the ambient temperature $T_{\text{amax}} = 85^\circ\text{C}$, the thermal impedance (Junction to Ambient) $\theta_{JA} = 20.3 \text{ }^\circ\text{C} / \text{W}$ (4-layer PCB),

$$\begin{aligned} T_j &= T_{\text{amax}} + P_C \times \theta_{JA} \\ &= 85 \text{ }^\circ\text{C} + 1.7 \text{ W} \times 20.3 \text{ }^\circ\text{C} / \text{W} \\ &= 119.5 \text{ }^\circ\text{C} \end{aligned}$$

When operating the IC, the top center of case's (mold) temperature $T_T = 100 \text{ }^\circ\text{C}$, $\Psi_{JT} = 8 \text{ }^\circ\text{C} / \text{W}$ (1-layer PCB),

$$\begin{aligned} T_j &= T_T + P_C \times \Psi_{JT} \\ &= 100 \text{ }^\circ\text{C} + 1.7 \text{ W} \times 8 \text{ }^\circ\text{C} / \text{W} \\ &= 113.6 \text{ }^\circ\text{C} \end{aligned}$$

For optimum thermal performance, it is recommended to expand the copper foil area of the board, increasing the layer and thermal via between thermal land pad.

· **Calculation Example (TO252-J5)**

If $V_{CC} = 13.5 \text{ V}$, $V_O = 5.0 \text{ V}$, $I_O = 200 \text{ mA}$, $I_{CC} = 75 \text{ }\mu\text{A}$, the power consumption P_C can be calculated as follows:

$$\begin{aligned} P_C &= (V_{CC} - V_O) \times I_O + V_{CC} \times I_{CC} \\ &= (13.5 \text{ V} - 5.0 \text{ V}) \times 200 \text{ mA} + 13.5 \text{ V} \times 75 \text{ }\mu\text{A} \\ &= 1.7 \text{ W} \end{aligned}$$

At the ambient temperature $T_{\text{amax}} = 85^\circ\text{C}$, the thermal impedance (Junction to Ambient) $\theta_{JA} = 23 \text{ }^\circ\text{C} / \text{W}$ (4-layer PCB),

$$\begin{aligned} T_j &= T_{\text{amax}} + P_C \times \theta_{JA} \\ &= 85 \text{ }^\circ\text{C} + 1.7 \text{ W} \times 23 \text{ }^\circ\text{C} / \text{W} \\ &= 124.1^\circ\text{C} \end{aligned}$$

When operating the IC, the top center of case's (mold) temperature $T_T = 100 \text{ }^\circ\text{C}$, $\Psi_{JT} = 17 \text{ }^\circ\text{C} / \text{W}$ (1-layer PCB),

$$\begin{aligned} T_j &= T_T + P_C \times \Psi_{JT} \\ &= 100 \text{ }^\circ\text{C} + 1.7 \text{ W} \times 17^\circ\text{C} / \text{W} \\ &= 128.9 \text{ }^\circ\text{C} \end{aligned}$$

For optimum thermal performance, it is recommended to expand the copper foil area of the board, increasing the layer and thermal via between thermal land pads.

Selection of Components Externally Connected

- VCC Pin Capacitor**
 Insert capacitors with a capacitance of 0.1 μF or higher between the VCC and GND pin. We recommend using ceramic capacitor generally featuring good high frequency characteristic. When selecting a ceramic capacitor, please consider about temperature and DC - biasing characteristics. And please place capacitors near VCC - GND pin as close as possible. When input impedance is high, e.g. in case there is distance from battery, line voltage drop needs to be prevented by large capacitor. Select the capacitance according to the line impedance between the power smoothing circuit and the VCC pin. Selection of the capacitance also depends on the applications. Verify the application and allow sufficient margins in the design. We recommend using a capacitor with excellent voltage and temperature characteristics.
- Output Pin Capacitor**
 In order to prevent oscillation, a capacitor needs to be placed between the output pin and GND pin. We recommend using a ceramic capacitor with a capacitance of 6 μF or higher. In selecting the capacitor, ensure that the capacitance of 6 μF or higher is maintained at the intended applied voltage and temperature range. Due to changes in temperature the capacitor's capacitance can fluctuate possibly resulting in oscillation.
 In actual applications the stable operating range is influenced by the PCB impedance, input supply impedance and load impedance. Therefore sufficient verification of the final operating environment is needed. When selecting a ceramic capacitor, we recommend using X7R or better components with excellent temperature and DC - biasing characteristics and high voltage tolerance.
 In case of the transient input voltage and the load current fluctuation, output voltage may fluctuate. In case this fluctuation can be problematic for the application, connect low ESR capacitor (capacitance > 6 μF , ESR < 1 Ω) in paralleled to large capacitor with a capacitance of 13 μF or higher and ESR of 5 Ω or lower. Electrolytic and tantalum and conductive polymer capacitors can be used as large capacitor. When selecting an electrolytic capacitor, please consider about increasing ESR and decreasing capacitance at cold temperature.
 We recommend placing the capacitor near output pin as close as possible.

I/O Equivalence Circuits

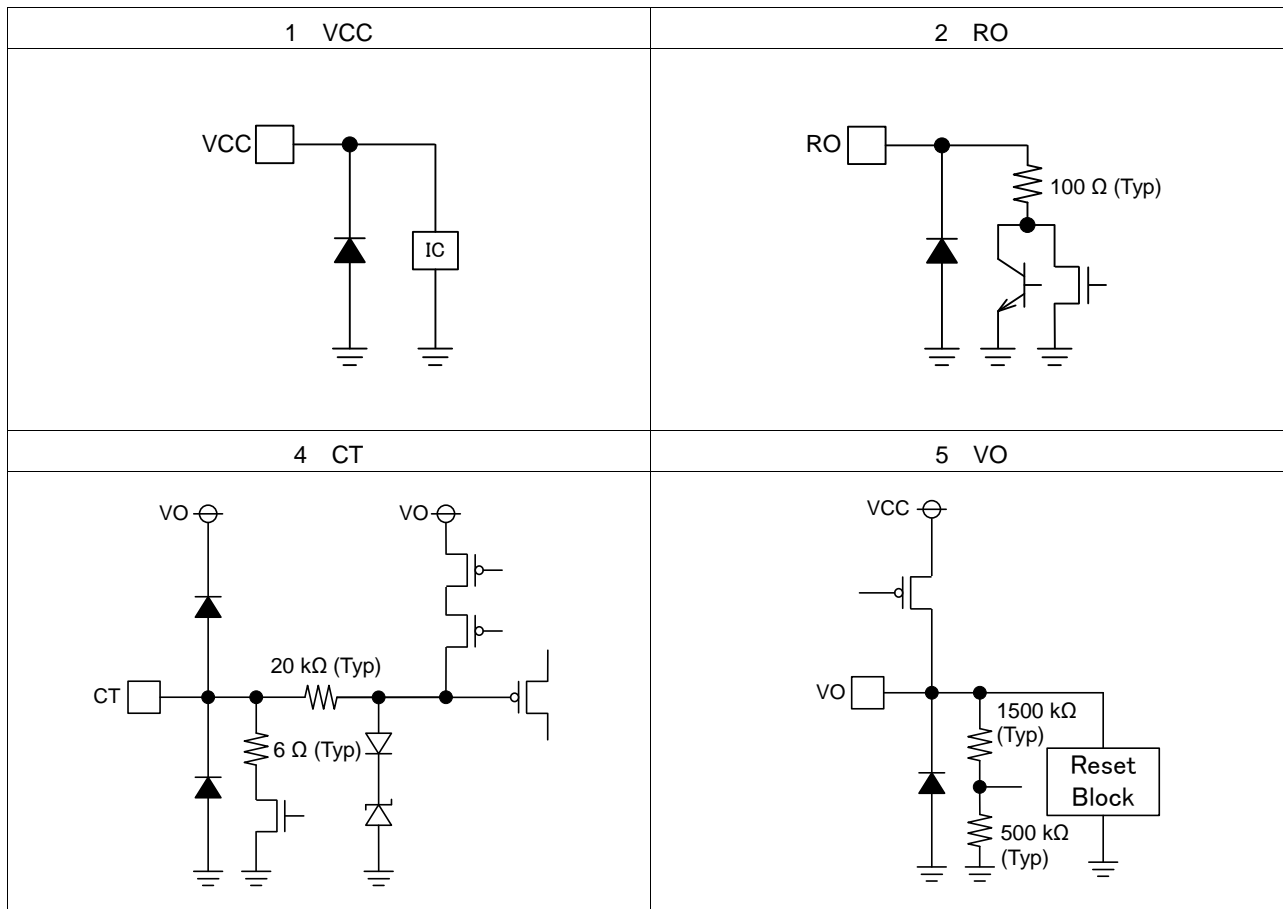

Figure 24. I / O equivalence circuits

Application Examples

- Applying positive surge to the VCC

If the possibility exists that surges higher than 45 V will be applied to the VCC, a Zener Diode should be placed between the VCC and GND as shown in the figure below.

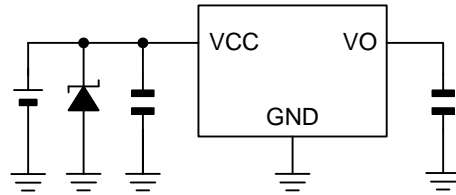

Figure 25. Application Example 1

- Applying negative surge to the VCC

If the possibility exists that negative surges lower than the GND are applied to the VCC, a Schottky Diode should be placed between the VCC and GND as shown in the figure below.

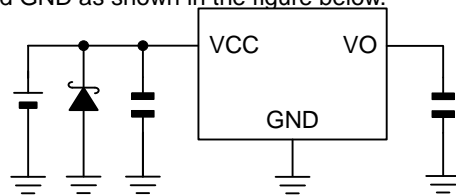

Figure 26. Application Example 2

- Implementing a Protection Diode

If the possibility exists that a large inductive load is connected to the output pin resulting in back-EMF at time of startup and shutdown, a protection diode should be placed as shown in the figure below.

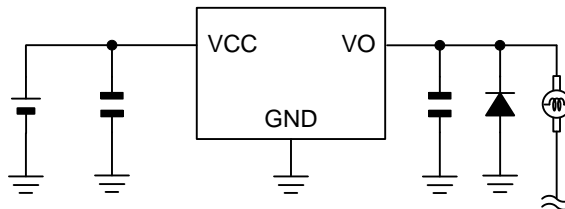

Figure 27. Application Example 3

- Reverse Polarity Diode

In some applications, the VCC and pin potential might be reversed, possibly resulting in circuit internal damage or damage to the elements. For example, while the external capacitor is charged, the A point shorts to the GND. Use a capacitor with a capacitance with 1000 μ F or less. We also recommend using reverse polarity diodes in series or a bypass between VO pins and the VCC.

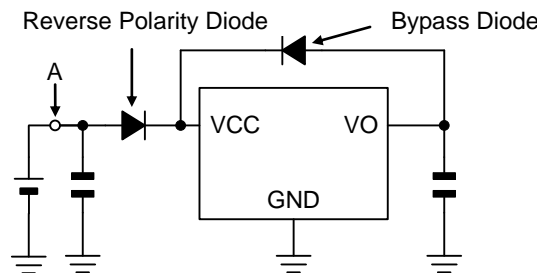

Figure 28. Application Example 4

Operational Notes

1. Reverse Connection of Power Supply

Connecting the power supply in reverse polarity can damage the IC. Take precautions against reverse polarity when connecting the power supply, such as mounting an external diode between the power supply and the IC's power supply pins.

2. Power Supply Lines

Design the PCB layout pattern to provide low impedance supply lines. Separate the ground and supply lines of the digital and analog blocks to prevent noise in the ground and supply lines of the digital block from affecting the analog block. Furthermore, connect a capacitor to ground at all power supply pins. Consider the effect of temperature and aging on the capacitance value when using electrolytic capacitors.

3. Ground Voltage

Ensure that no pins are at a voltage below that of the ground pin at any time, even during transient condition.

4. Ground Wiring Pattern

When using both small-signal and large-current ground traces, the two ground traces should be routed separately but connected to a single ground at the reference point of the application board to avoid fluctuations in the small-signal ground caused by large currents. Also ensure that the ground traces of external components do not cause variations on the ground voltage. The ground lines must be as short and thick as possible to reduce line impedance.

5. Thermal Consideration

Should by any chance the power dissipation rating be exceeded the rise in temperature of the chip may result in deterioration of the properties of the chip. Power dissipation is the value when the IC is mounted on a 114.3mm x 76.2mm x 1.57mm/1.6mm glass epoxy board. And in case this exceeds, take the measures like enlarge the size of board; make copper foil area for heat dissipation big; and do not exceed the power dissipation.

6. Inrush Current

When power is first supplied to the IC, it is possible that the internal logic may be unstable and inrush current may flow instantaneously due to the internal powering sequence and delays, especially if the IC has more than one power supply. Therefore, give special consideration to power coupling capacitance, power wiring, width of ground wiring, and routing of connections.

7. Testing on Application Boards

When testing the IC on an application board, connecting a capacitor directly to a low-impedance output pin may subject the IC to stress. Always discharge capacitors completely after each process or step. The IC's power supply should always be turned off completely before connecting or removing it from the test setup during the inspection process. To prevent damage from static discharge, ground the IC during assembly and use similar precautions during transport and storage.

8. Inter-pin Short and Mounting Errors

Ensure that the direction and position are correct when mounting the IC on the PCB. Incorrect mounting may result in damaging the IC. Avoid nearby pins being shorted to each other especially to ground, power supply and output pin. Inter-pin shorts could be due to many reasons such as metal particles, water droplets (in very humid environment) and unintentional solder bridge deposited in between pins during assembly to name a few.

Operational Notes – Continued

9. Unused Input Pins

Input pins of an IC are often connected to the gate of a MOS transistor. The gate has extremely high impedance and extremely low capacitance. If left unconnected, the electric field from the outside can easily charge it. The small charge acquired in this way is enough to produce a significant effect on the conduction through the transistor and cause unexpected operation of the IC. So unless otherwise specified, unused input pins should be connected to the power supply or ground line.

10. Regarding the Input Pin of the IC

This monolithic IC contains P+ isolation and P substrate layers between adjacent elements in order to keep them isolated. P-N junctions are formed at the intersection of the P layers with the N layers of other elements, creating a parasitic diode or transistor. For example (refer to figure below):

When $GND > Pin A$ and $GND > Pin B$, the P-N junction operates as a parasitic diode.
When $GND > Pin B$, the P-N junction operates as a parasitic transistor.

Parasitic diodes inevitably occur in the structure of the IC. The operation of parasitic diodes can result in mutual interference among circuits, operational faults, or physical damage. Therefore, conditions that cause these diodes to operate, such as applying a voltage lower than the GND voltage to an input pin (and thus to the P substrate) should be avoided.

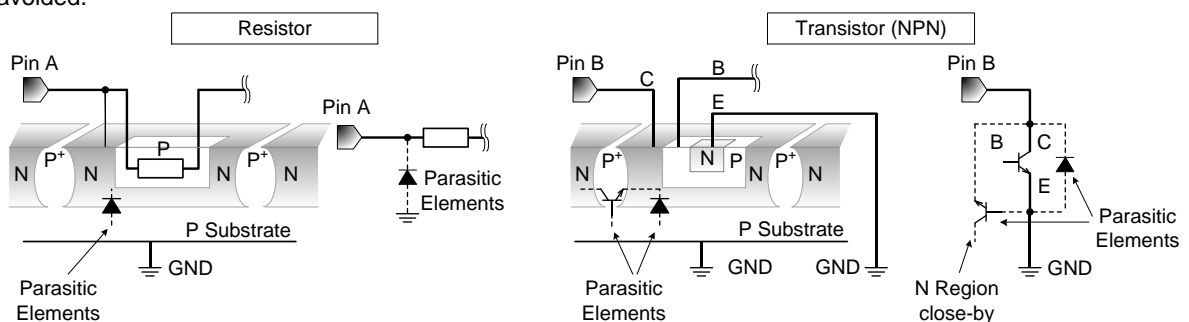
**11. Ceramic Capacitor**

When using a ceramic capacitor, determine the dielectric constant considering the change of capacitance with temperature and the decrease in nominal capacitance due to DC bias and others.

12. Thermal Shutdown Circuit(TSD)

This IC has a built-in thermal shutdown circuit that prevents heat damage to the IC. Normal operation should always be within the IC's power dissipation rating. If however the rating is exceeded for a continued period, the junction temperature (T_j) will rise which will activate the TSD circuit that will turn OFF all output pins. When the T_j falls below the TSD threshold, the circuits are automatically restored to normal operation.

Note that the TSD circuit operates in a situation that exceeds the absolute maximum ratings and therefore, under no circumstances, should the TSD circuit be used in a set design or for any purpose other than protecting the IC from heat damage.

13. Over Current Protection Circuit (OCP)

This IC incorporates an integrated overcurrent protection circuit that is activated when the load is shorted. This protection circuit is effective in preventing damage due to sudden and unexpected incidents. However, the IC should not be used in applications characterized by continuous operation or transitioning of the protection circuit.

Ordering Information

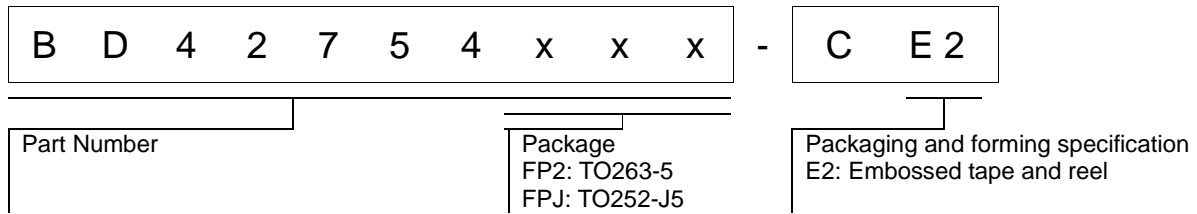

Marking Diagram

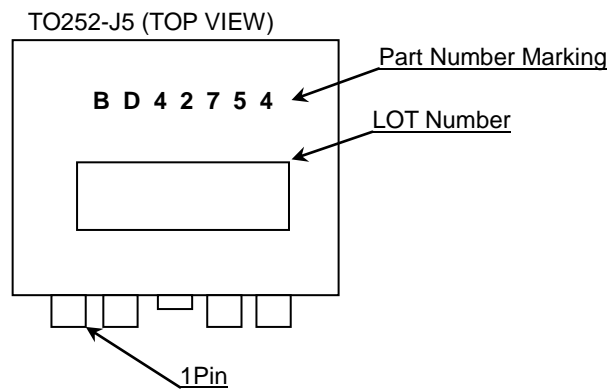
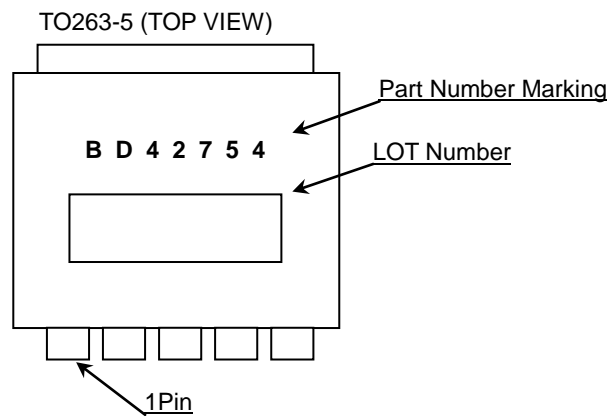

Physical Dimension Tape and Reel Information

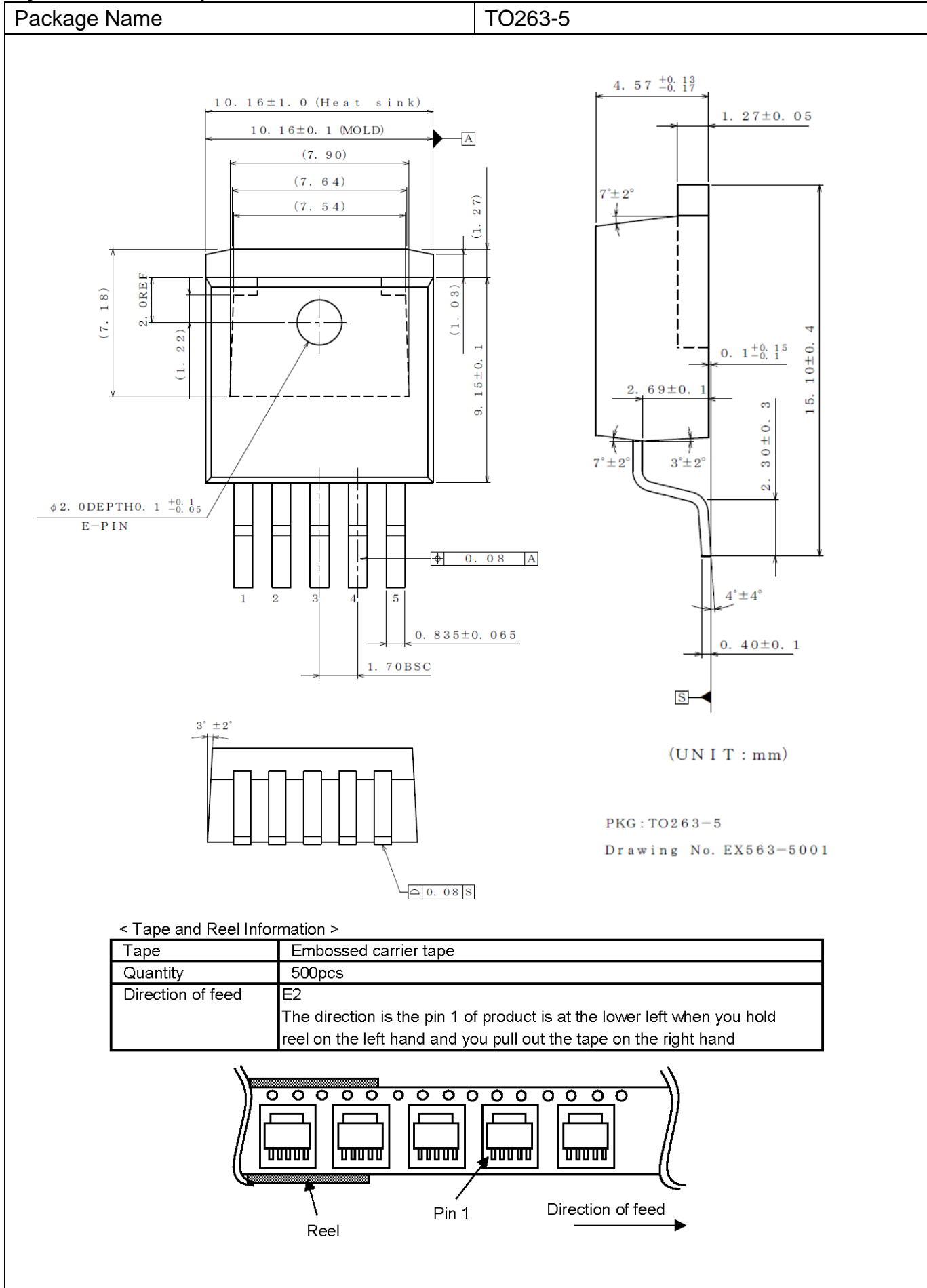

Package Name

TO252-J5

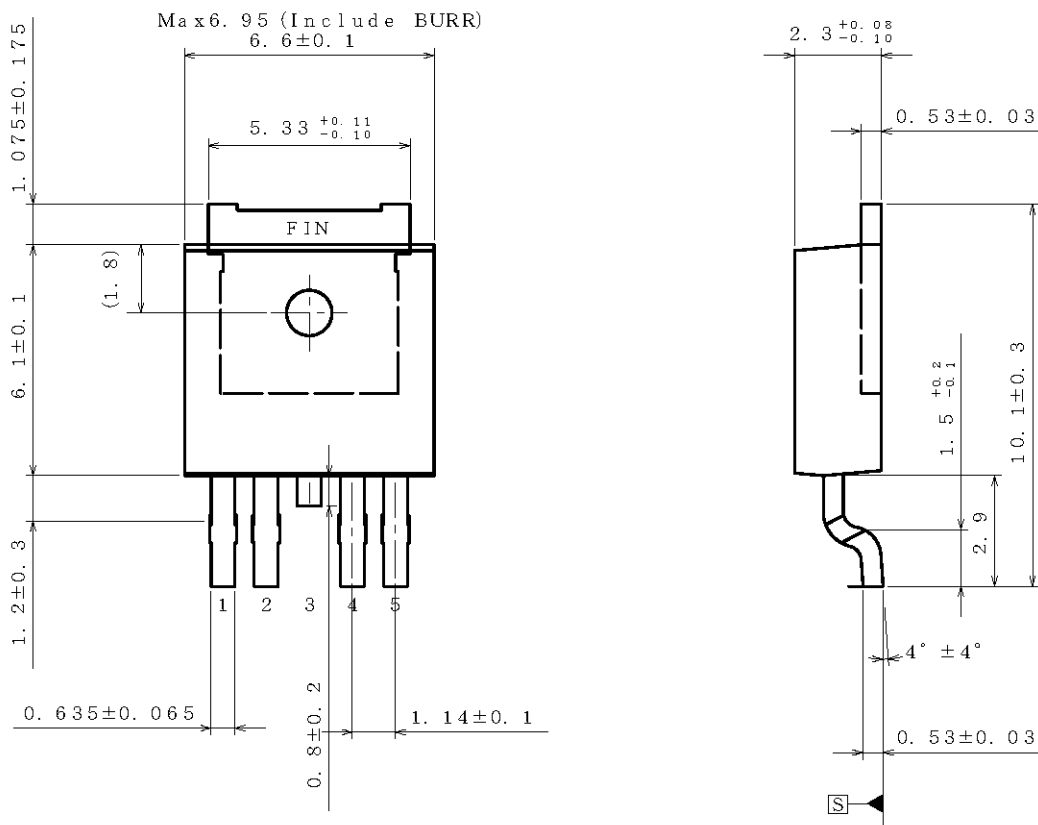

(UNIT : mm)

PKG : TO252-J5
 Drawing No. EX575-5002

< Tape and Reel Information >

Tape	Embossed carrier tape with dry pack
Quantity	2000pcs
Direction of feed	E2 The direction is the pin 1 of product is at the lower left when you hold reel on the left hand and you pull out the tape on the right hand

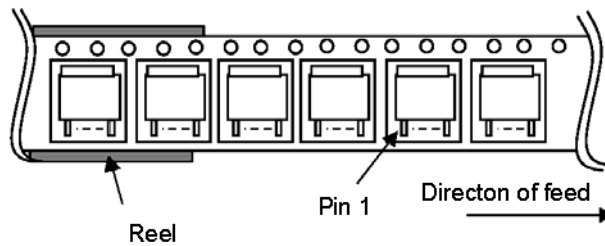

*Order quantity needs to be multiple of the minimum quantity.

Revision History

Date	Revision	Changes
19.Dec.2016	001	New Release
07.Mar.2017	002	TO252-J5 PKG was added
11.Mar.2019	003	Unit corrected in Figure 11 on Page 8.

Notice

Precaution on using ROHM Products

1. If you intend to use our Products in devices requiring extremely high reliability (such as medical equipment ^(Note 1), aircraft/spacecraft, nuclear power controllers, etc.) and whose malfunction or failure may cause loss of human life, bodily injury or serious damage to property ("Specific Applications"), please consult with the ROHM sales representative in advance. Unless otherwise agreed in writing by ROHM in advance, ROHM shall not be in any way responsible or liable for any damages, expenses or losses incurred by you or third parties arising from the use of any ROHM's Products for Specific Applications.

(Note1) Medical Equipment Classification of the Specific Applications

JAPAN	USA	EU	CHINA
CLASS III	CLASS III	CLASS II b	CLASS III
CLASS IV		CLASS III	

2. ROHM designs and manufactures its Products subject to strict quality control system. However, semiconductor products can fail or malfunction at a certain rate. Please be sure to implement, at your own responsibilities, adequate safety measures including but not limited to fail-safe design against the physical injury, damage to any property, which a failure or malfunction of our Products may cause. The following are examples of safety measures:
 - [a] Installation of protection circuits or other protective devices to improve system safety
 - [b] Installation of redundant circuits to reduce the impact of single or multiple circuit failure
3. Our Products are not designed under any special or extraordinary environments or conditions, as exemplified below. Accordingly, ROHM shall not be in any way responsible or liable for any damages, expenses or losses arising from the use of any ROHM's Products under any special or extraordinary environments or conditions. If you intend to use our Products under any special or extraordinary environments or conditions (as exemplified below), your independent verification and confirmation of product performance, reliability, etc, prior to use, must be necessary:
 - [a] Use of our Products in any types of liquid, including water, oils, chemicals, and organic solvents
 - [b] Use of our Products outdoors or in places where the Products are exposed to direct sunlight or dust
 - [c] Use of our Products in places where the Products are exposed to sea wind or corrosive gases, including Cl₂, H₂S, NH₃, SO₂, and NO₂
 - [d] Use of our Products in places where the Products are exposed to static electricity or electromagnetic waves
 - [e] Use of our Products in proximity to heat-producing components, plastic cords, or other flammable items
 - [f] Sealing or coating our Products with resin or other coating materials
 - [g] Use of our Products without cleaning residue of flux (Exclude cases where no-clean type fluxes is used. However, recommend sufficiently about the residue.); or Washing our Products by using water or water-soluble cleaning agents for cleaning residue after soldering
 - [h] Use of the Products in places subject to dew condensation
4. The Products are not subject to radiation-proof design.
5. Please verify and confirm characteristics of the final or mounted products in using the Products.
6. In particular, if a transient load (a large amount of load applied in a short period of time, such as pulse, is applied, confirmation of performance characteristics after on-board mounting is strongly recommended. Avoid applying power exceeding normal rated power; exceeding the power rating under steady-state loading condition may negatively affect product performance and reliability.
7. De-rate Power Dissipation depending on ambient temperature. When used in sealed area, confirm that it is the use in the range that does not exceed the maximum junction temperature.
8. Confirm that operation temperature is within the specified range described in the product specification.
9. ROHM shall not be in any way responsible or liable for failure induced under deviant condition from what is defined in this document.

Precaution for Mounting / Circuit board design

1. When a highly active halogenous (chlorine, bromine, etc.) flux is used, the residue of flux may negatively affect product performance and reliability.
2. In principle, the reflow soldering method must be used on a surface-mount products, the flow soldering method must be used on a through hole mount products. If the flow soldering method is preferred on a surface-mount products, please consult with the ROHM representative in advance.

For details, please refer to ROHM Mounting specification

Precautions Regarding Application Examples and External Circuits

1. If change is made to the constant of an external circuit, please allow a sufficient margin considering variations of the characteristics of the Products and external components, including transient characteristics, as well as static characteristics.
2. You agree that application notes, reference designs, and associated data and information contained in this document are presented only as guidance for Products use. Therefore, in case you use such information, you are solely responsible for it and you must exercise your own independent verification and judgment in the use of such information contained in this document. ROHM shall not be in any way responsible or liable for any damages, expenses or losses incurred by you or third parties arising from the use of such information.

Precaution for Electrostatic

This Product is electrostatic sensitive product, which may be damaged due to electrostatic discharge. Please take proper caution in your manufacturing process and storage so that voltage exceeding the Products maximum rating will not be applied to Products. Please take special care under dry condition (e.g. Grounding of human body / equipment / solder iron, isolation from charged objects, setting of Ionizer, friction prevention and temperature / humidity control).

Precaution for Storage / Transportation

1. Product performance and soldered connections may deteriorate if the Products are stored in the places where:
 - [a] the Products are exposed to sea winds or corrosive gases, including Cl₂, H₂S, NH₃, SO₂, and NO₂
 - [b] the temperature or humidity exceeds those recommended by ROHM
 - [c] the Products are exposed to direct sunshine or condensation
 - [d] the Products are exposed to high Electrostatic
2. Even under ROHM recommended storage condition, solderability of products out of recommended storage time period may be degraded. It is strongly recommended to confirm solderability before using Products of which storage time is exceeding the recommended storage time period.
3. Store / transport cartons in the correct direction, which is indicated on a carton with a symbol. Otherwise bent leads may occur due to excessive stress applied when dropping of a carton.
4. Use Products within the specified time after opening a humidity barrier bag. Baking is required before using Products of which storage time is exceeding the recommended storage time period.

Precaution for Product Label

A two-dimensional barcode printed on ROHM Products label is for ROHM's internal use only.

Precaution for Disposition

When disposing Products please dispose them properly using an authorized industry waste company.

Precaution for Foreign Exchange and Foreign Trade act

Since concerned goods might be fallen under listed items of export control prescribed by Foreign exchange and Foreign trade act, please consult with ROHM in case of export.

Precaution Regarding Intellectual Property Rights

1. All information and data including but not limited to application example contained in this document is for reference only. ROHM does not warrant that foregoing information or data will not infringe any intellectual property rights or any other rights of any third party regarding such information or data.
2. ROHM shall not have any obligations where the claims, actions or demands arising from the combination of the Products with other articles such as components, circuits, systems or external equipment (including software).
3. No license, expressly or implied, is granted hereby under any intellectual property rights or other rights of ROHM or any third parties with respect to the Products or the information contained in this document. Provided, however, that ROHM will not assert its intellectual property rights or other rights against you or your customers to the extent necessary to manufacture or sell products containing the Products, subject to the terms and conditions herein.

Other Precaution

1. This document may not be reprinted or reproduced, in whole or in part, without prior written consent of ROHM.
2. The Products may not be disassembled, converted, modified, reproduced or otherwise changed without prior written consent of ROHM.
3. In no event shall you use in any way whatsoever the Products and the related technical information contained in the Products or this document for any military purposes, including but not limited to, the development of mass-destruction weapons.
4. The proper names of companies or products described in this document are trademarks or registered trademarks of ROHM, its affiliated companies or third parties.

General Precaution

1. Before you use our Products, you are requested to carefully read this document and fully understand its contents. ROHM shall not be in any way responsible or liable for failure, malfunction or accident arising from the use of any ROHM's Products against warning, caution or note contained in this document.
2. All information contained in this document is current as of the issuing date and subject to change without any prior notice. Before purchasing or using ROHM's Products, please confirm the latest information with a ROHM sales representative.
3. The information contained in this document is provided on an "as is" basis and ROHM does not warrant that all information contained in this document is accurate and/or error-free. ROHM shall not be in any way responsible or liable for any damages, expenses or losses incurred by you or third parties resulting from inaccuracy or errors of or concerning such information.