

SK6513S High Voltage, Low Power LDO

DESCRIPTION

The SK6513S is a high voltage, low power consumption and high performance LDO. The family uses an advanced CMOS process and a PMOSFET pass device to achieve fast start-up, with high output voltage accuracy.

The SK6513S is stable with a $1\mu\text{F} \sim 10\mu\text{F}$ ceramic output capacitor, and uses a precision voltage reference and feedback loop to achieve a worst-case accuracy of 2% over all load, line, process, and temperature variations.

The SK6513S is available in standard DFN1×1-4, SOT23-3, SOT23-5, SOT89-3 package and Standard products are Pb-free and Halogen-free.

FEATURES

- Wide Input Voltage Range: 2.5~36V
- Up to 300mA Load Current
- Standard Fixed Output Voltage Options: 1.8 V, 2.5 V, 3.0 V, 3.3 V, 3.6 V and 5.0 V
- Other Output Voltage Options Available on Request
- Low IQ: $2.5\mu\text{A}$
- Low Dropout Voltage: 330mV @100mA, when $V_{\text{OUT}} = 3\text{V}$
- Short current protection: 150mA
- Excellent Load/Line Transient Response
- Line Regulation: 0.01 %/V typical

APPLICATION

- Battery powered equipment
- Voltage regulator for LAN cards
- Wireless communication equipment
- Audio/Video equipment

TYPICAL APPLICATION CIRCUITS

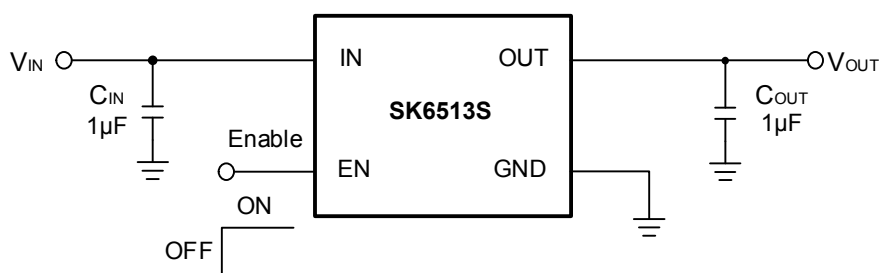

PIN CONFIGURATION (Top View)

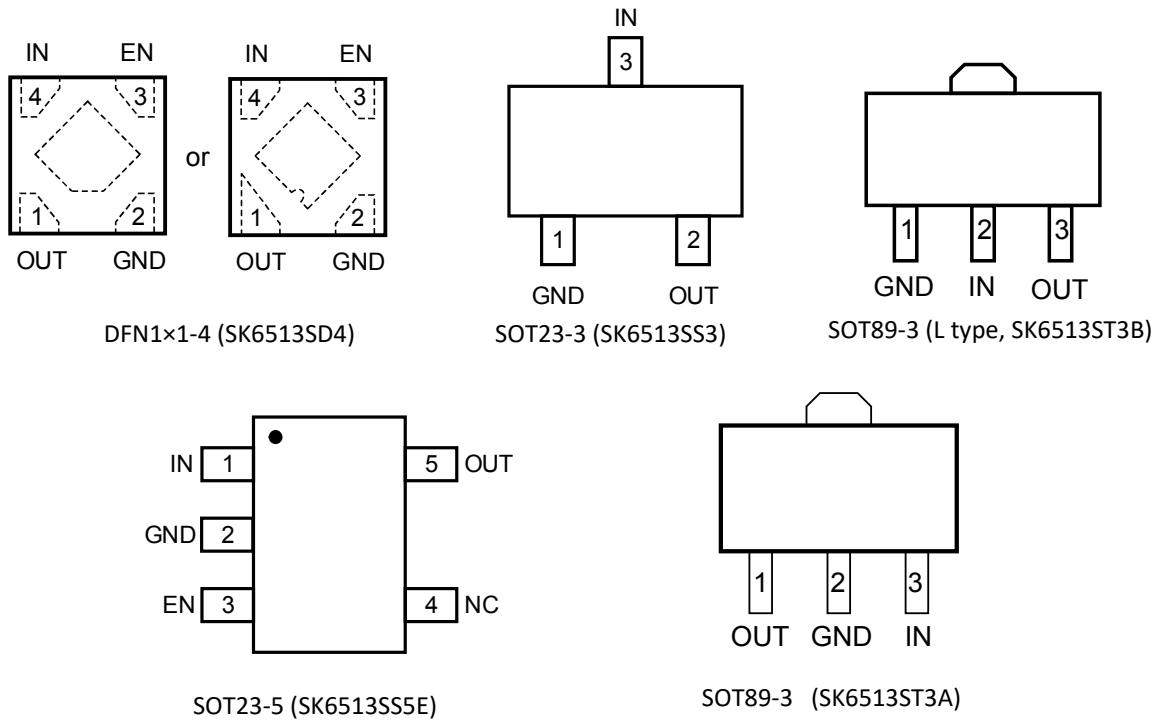

PIN DESCRIPTIONS

Pin					Symbol	Description
DFN1×1-4 (SK6513SD4-XX)	SOT23-3 (SK6513SS3-XX)	SOT23-5 (SK6513SS5E-XX)	SOT89-3 (SK6513ST3A-XX)	SOT89-3 (SK6513ST3B-XX)		
1	2	5	1	3	OUT	Output pin.
2	1	2	2	1	GND	Ground.
3		3			EN	Enable control input, active high.
4	3	1	3	2	IN	Supply input pin.
		4			NC	No connection.

ORDERING INFORMATION

Ordering Number	Package	Tape and Reel
SK6513SD4-XX	DFN1×1-4	10000/Reel
SK6513SS3-XX	SOT23-3	3000/Reel
SK6513SS5E-XX	SOT23-5	3000/Reel
SK6513ST3A-XX	SOT89-3	1000/Reel
SK6513ST3B-XX(L-Type)	SOT89-3	1000/Reel

*XX: When expressed as 18, the output voltage is 1.8V; when expressed as 30 the output voltage is 3.0V.
The SK6513S devices are Pb-free and RoHS compliant.

PART NUMBER RULES

SK6513S 1-2

Output Voltage :

XX indicates output voltage, example: 28 indicates 2.8V output voltage.

Package:

D4: DFN1x1-4; **S3**: SOT23-3; **S5E**: SOT23-5;

T3A: SOT89-3; **T3B**: SOT89-3 (L type)

ABSOLUTE MAXIMUM RATINGS

Parameter	Rating	Unit
IN pin to GND pin	0 to 44	V
OUT pin to GND pin	0.8 to 6	V
Thermal Resistance (Junction to Ambient)	DFN1 ×1-4	250
	SOT23-3	360
	SOT23-5	250
	SOT89-3	135
Operating Junction Temperature	-40 to 125	°C
Storage Temperature	-55 to 150	°C
Lead Temperature (Soldering, 10 sec)	260	°C
ESD (HBM mode) Tested per EIA/JESD22-A114	2000	V
ESD (CDM Capability) Tested per JESD22-C101	1500	V
Latch up Current Maximum Rating	200	mA

Note (1): Stresses beyond those listed under “ABSOLUTE MAXIMUM RATINGS” may cause permanent damage to the device. These are stress ratings only, and functional operation of the device at these or any other conditions beyond those indicated in the operational sections of the specifications is not implied. Exposure to absolute maximum rating conditions for extended periods may affect device reliability.

CAUTION

This integrated circuit can be damaged by ESD if you don't pay attention to ESD protection. SUNTEK recommends that all integrated circuits be handled with appropriate precautions. Failure to observe proper handling and installation procedures can cause damage. ESD damage can range from subtle performance degradation to complete device failure. Precision integrated circuits may be more susceptible to damage because very small parametric changes could cause the device not to meet its published specifications. SUNTEK reserves the right to make any change in circuit design, specification or other related things if necessary without notice at any time. Please contact SUNTEK sales office to get the latest datasheet.

RECOMMENDED OPERATING CONDITIONS

Symbol	Item	Rating	Unit
V_{IN}	Input Voltage	2.5 to 36	V
I_{OUT}	Output Current	0 to 300	mA
T_A	Operating Ambient Temperature	-40 to 85	°C
C_{IN}	Effective Input Ceramic Capacitor Value	1 to 10	uF
C_{OUT}	Effective Output Ceramic Capacitor Value	1 to 10	uF
ESR	Input and Output Capacitor Equivalent Series Resistance (ESR)	5 to 100	mΩ

ELECTRICAL CHARACTERISTICS

$V_{IN} = V_{OUT} + 2V$; $I_{OUT} = 10mA$, $C_{IN} = C_{OUT} = 1.0\mu F$, unless otherwise noted. Typical values are at $T_A = +25^\circ C$.

Parameter	Symbol	Test Conditions	Min	Typ	Max	Unit
Operating Input Voltage	V_{IN}		2.5	36		V
Line Regulation	Reg_{LINE}	$2.5V \leq V_{IN} \leq 36V$, $I_{OUT} = 10mA$		0.05	0.20	%/V
Dropout Voltage	V_{DROP}	$V_{OUT} = 3.0V$, $I_{OUT} = 100mA$		330		mV
		$V_{OUT} = 3.0V$, $I_{OUT} = 200mA$		690		
Load Regulation	Reg_{LOAD}	$1mA \leq I_{OUT} \leq 300mA$, $V_{IN} = V_{OUT} + 2V$			40	mV
Current Limit	I_{LMT}	$V_{IN} = V_{OUT} + 2V$	300	450		mA
Quiescent Current	I_Q	$I_{OUT} = 0mA$		2.5	4.5	μA
Standby Current	I_{Q_OFF}	$V_{EN} = 0V$, $T_A = 25^\circ C$		0.1	1	μA
EN Pin Threshold Voltage	V_{ENH}	EN Input Voltage "H"	1.2			V
EN Pin Threshold Voltage	V_{ENL}	EN Input Voltage "L"			0.4	V
EN Pin Current	I_{EN}	$V_{EN} = 0V$ to 36V		1		μA
Power Supply Rejection Ratio	PSRR	$V_{IN} = V_{OUT} + 1V$, $I_{OUT} = 20mA$ $f = 1 kHz$		60		dB
Output Noise Voltage	e_N	$V_{IN} = V_{OUT} + 2V$, $I_{OUT} = 1mA$ $f = 10Hz$ to 100kHz $V_{OUT} = 3V$, $C_{OUT} = 1\mu F$		100		μV _{RMS}
Thermal Shutdown Temperature	T_{SD}	Temperature Increasing from $T_A = +25^\circ C$		155		°C
Thermal Shutdown Hysteresis	T_{SDH}	Temperature Falling from TSD		30		°C

BLOCK DIAGRAM

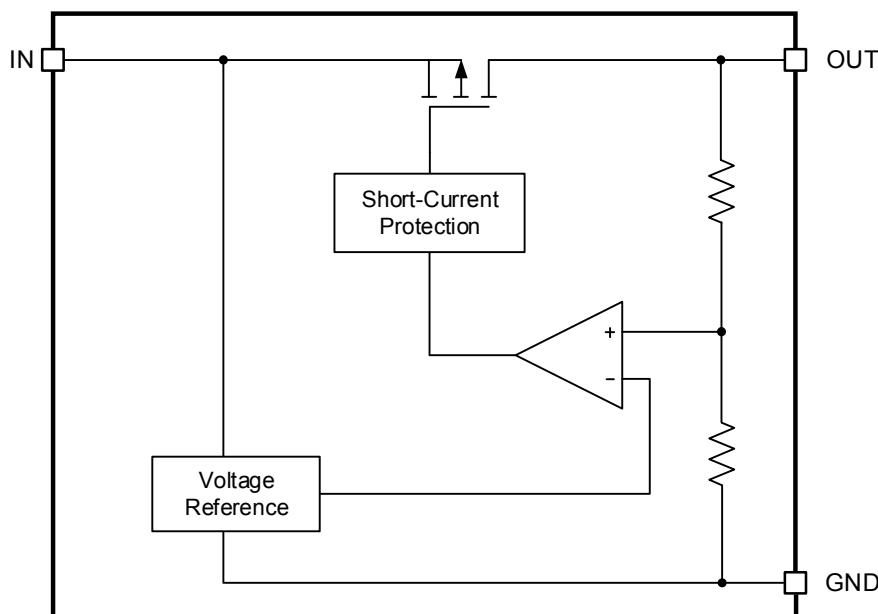

FUNCTIONAL DESCRIPTION

Input Capacitor

A $1\mu\text{F} \sim 10\mu\text{F}$ ceramic capacitor is recommended to connect between IN and GND pins to decouple input power supply glitch and noise. The amount of the capacitance may be increased without limit. This input capacitor must be located as close as possible to the device to assure input stability and less noise. For PCB layout, a wide copper trace is required for both IN and GND.

Output Capacitor

An output capacitor is required for the stability of the LDO. The recommended output capacitance is from $1\mu\text{F}$ to $10\mu\text{F}$, Equivalent Series Resistance (ESR) is from $5\text{m}\Omega$ to $100\text{m}\Omega$, and temperature characteristics are X7R or X5R. Higher capacitance values help to improve load / line transient response. The output capacitance may be increased to keep low undershoot / overshoot. Place output capacitor as close as possible to OUT and GND pins.

Low Quiescent Current

The SK6513S, consuming only around $2.6\mu\text{A}$ for all input range and output loading, provides great power saving in portable and low power applications.

Short Current Limit Protection

When output current at the OUT pin is higher than current limit threshold or the OUT pin is short-circuit to GND, the short current limit protection will be triggered and clamp the output current to approximately 100mA to prevent over-current and to protect the regulator from damage due to overheating.

TYPICAL PERFORMANCE CHARACTERISTICS

VOLTAGE VERSION 3.3V

($V_{IN} = V_{OUT} + 2V$, $I_{OUT} = 10mA$, $C_{IN} = C_{OUT} = 1.0\mu F$, unless otherwise noted. Typical values are at $T_A = +25^\circ C$.)

Output Voltage VS Temperature

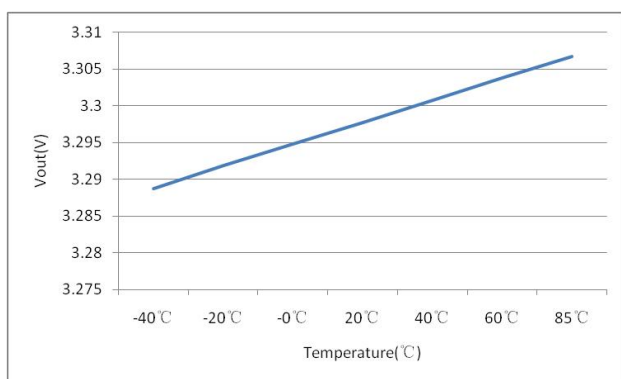

Quiescent Current VS Temperature

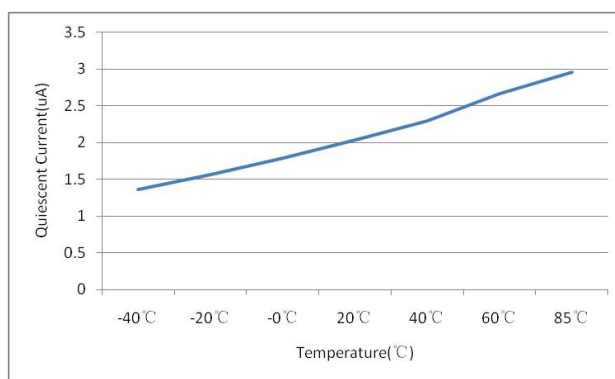

Ground Current VS Output Current

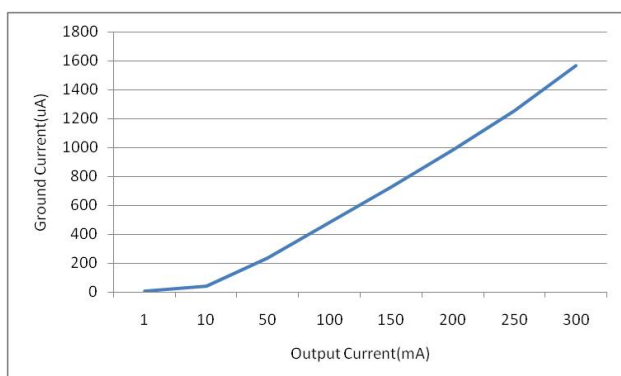

Dropout Voltage VS Output Current

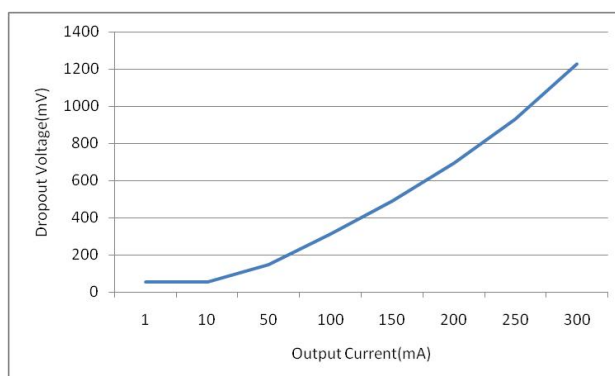

Output Voltage VS Input Voltage

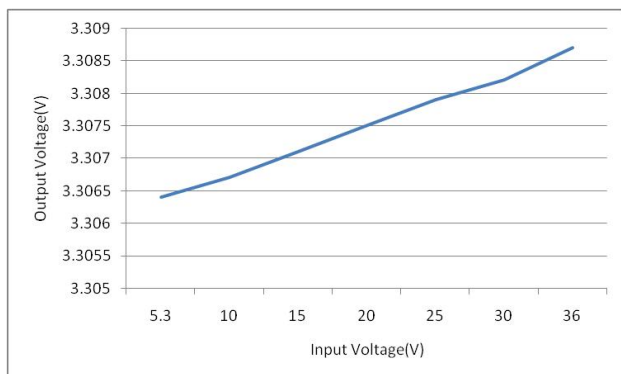

Output Voltage VS Output Current

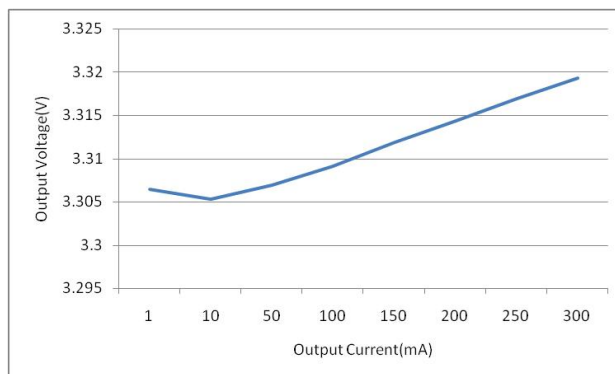

TYPICAL PERFORMANCE CHARACTERISTICS (continued)

PSRR

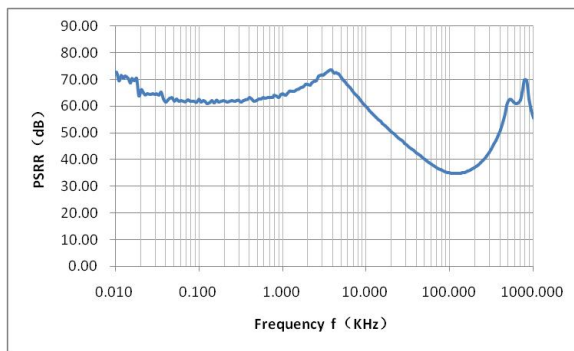

Line-Transient Response

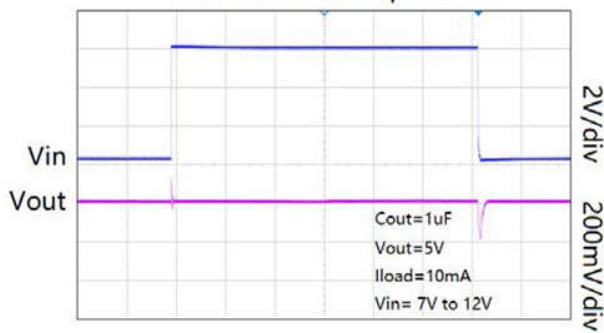

Time(1ms/div)

Line-Transient Response

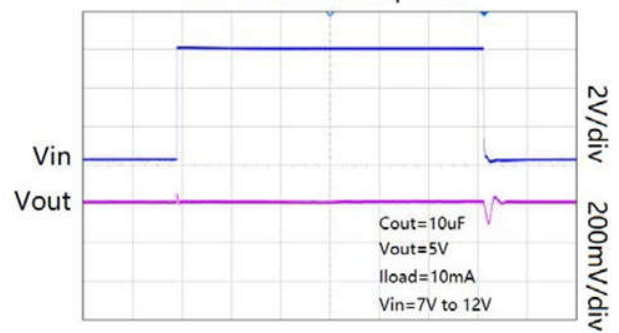

Time(1ms/div)

Load-Transient Response

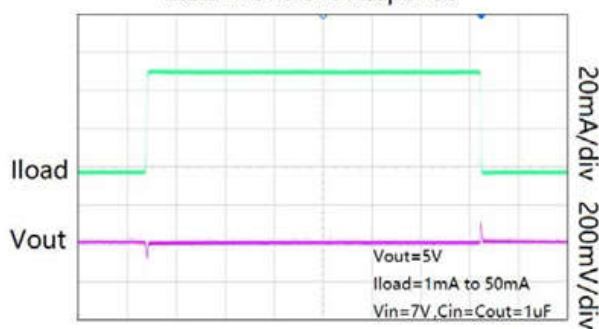

Time(5ms/div)

Load-Transient Response

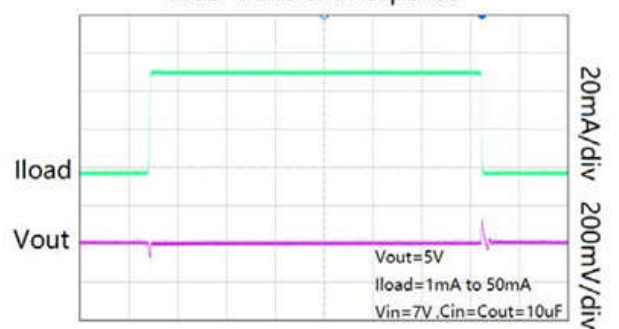

Time(5ms/div)

Start up Response

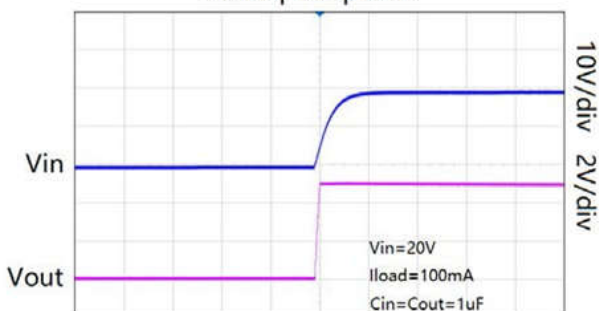

Time(10ms/div)

Start up Response

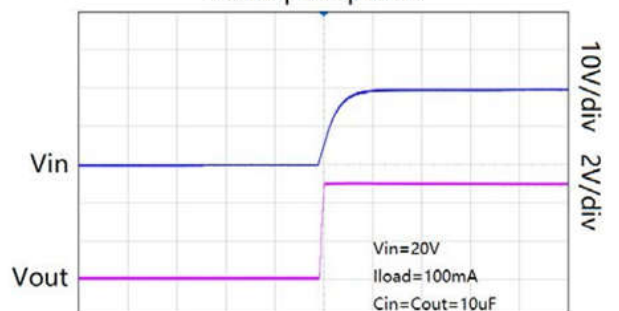

Time(10ms/div)

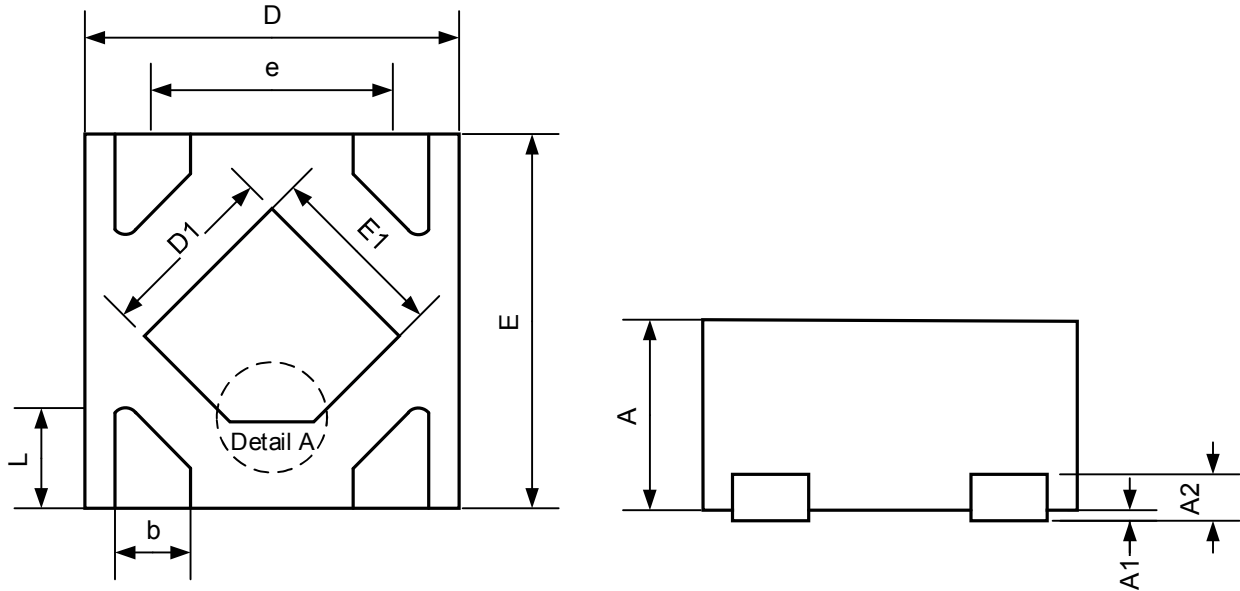
PACKAGE DIMENSION: DFN1×1-4

Detail A:



Note: Detail A has two kinds of shapes

Symbol	Dimensions In Millimeters	
	Min	Max
A		0.500
A1	0.000	0.050
A2	0.125REF	
b	0.150	0.250
D	0.950	1.050
D1	0.380	0.580
E	0.950	1.050
E1	0.380	0.580
e	0.650BSC	
L	0.150	0.350

PACKAGE DIMENSION: SOT23-3

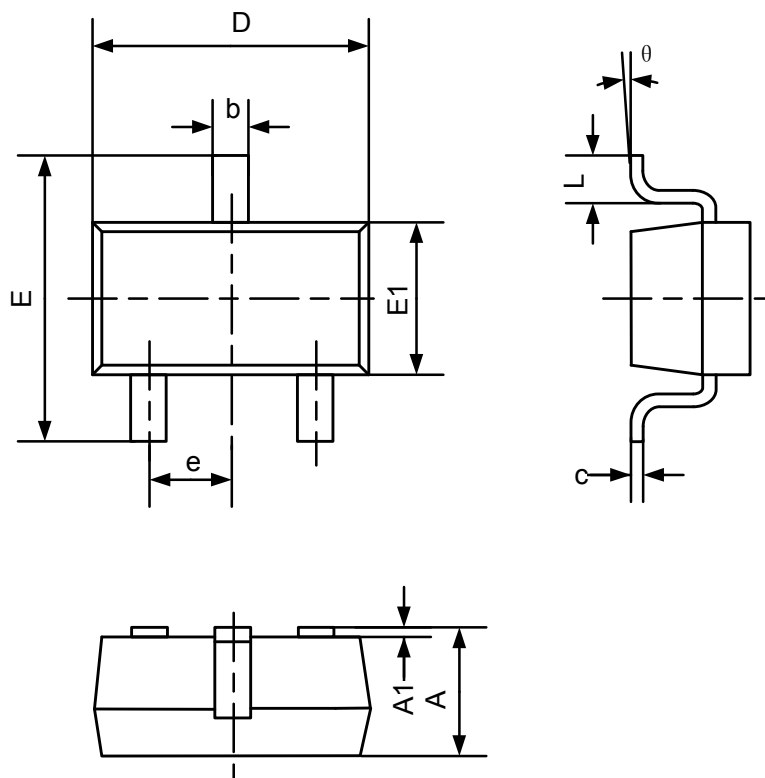

Symbol	Dimensions In Millimeters	
	Min	Max
A	1.050	1.250
A1	0.000	0.100
b	0.300	0.500
c	0.100	0.200
D	2.820	3.020
E	2.650	2.950
E1	1.500	1.700
e	0.950BSC	
L	0.300	0.600
θ	0°	8°

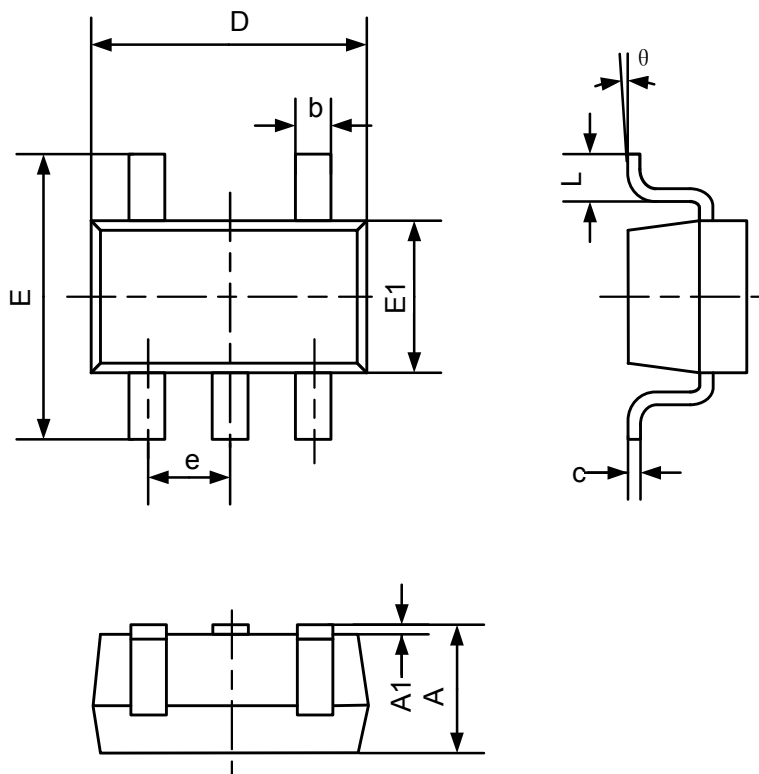
PACKAGE DIMENSION: SOT23-5

Symbol	Dimensions In Millimeters	
	Min	Max
A	1.050	1.250
A1	0.000	0.100
b	0.300	0.500
c	0.100	0.200
D	2.820	3.020
E	2.650	2.950
E1	1.500	1.700
e	0.950BSC	
L	0.300	0.600
θ	0°	8°

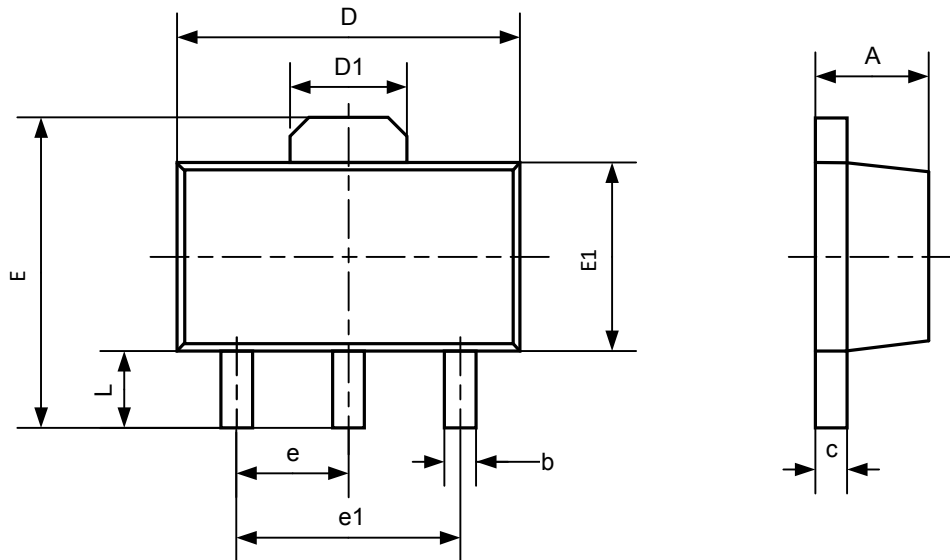
PACKAGE DIMENSION: SOT89-3

Symbol	Dimensions In Millimeters	
	Min	Max
A	1.400	1.600
b	0.320	0.520
c	0.350	0.440
D	4.400	4.600
D1	1.550REF	
E	3.940	4.250
E1	2.300	2.600
e	1.500BSC	
e1	3.000BSC	
L	0.900	1.200