

### General Description

The 85R290R is power MOSFET using Cmos's advanced super junction technology that can realize very low on resistance and gate charge. It will provide much high efficiency by using optimized charge coupling technology. These user friendly devices give an advantage of low EMI to designers as well as low switching loss.

### Features

- Low On-Resistance
- 100% avalanche tested
- RoHS Compliant

### Product Summary

| BVDSS | R <sub>DS(on)</sub> max. | ID  |
|-------|--------------------------|-----|
| 850V  | 260mΩ                    | 19A |

### Applications

- Charger
- Adaptor
- Power Supply

### TO-220/263/262/220F Pin Configuration

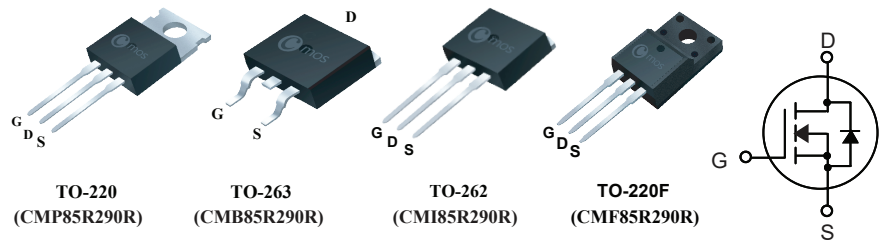

### Absolute Maximum Ratings

| Symbol                                | Parameter                              | 220/263/262 | 220F | Units |
|---------------------------------------|--|-------------|------|-------|
| V <sub>DS</sub>                       | Drain-Source Voltage                   | 850         |      | V     |
| V <sub>GS</sub>                       | Gate-Source Voltage                    | ±30         |      | V     |
| I <sub>D</sub> @T <sub>C</sub> =25°C  | Continuous Drain Current               | 19          | 19*  | A     |
| I <sub>D</sub> @T <sub>C</sub> =100°C | Continuous Drain Current               | 12          | 12*  | A     |
| I <sub>DM</sub>                       | Pulsed Drain Current                   | 76          | 76*  | A     |
| EAS                                   | Single Pulse Avalanche Energy (Note 1) | 29.4        |      | mJ    |
| P <sub>D</sub> @T <sub>C</sub> =25°C  | Total Power Dissipation                | 220         | 43   | W     |
| T <sub>STG</sub>                      | Storage Temperature Range              | -55 to 150  |      | °C    |
| T <sub>J</sub>                        | Operating Junction Temperature Range   | -55 to 150  |      | °C    |

\* Drain current limited by maximum junction temperature.

### Thermal Data

| Symbol           | Parameter                                | 220/263/262 | 220F | Unit |
|------------------|--|-------------|------|------|
| R <sub>θJA</sub> | Thermal Resistance Junction-ambient Max. | 63.6        | 63.6 | °C/W |
| R <sub>θJC</sub> | Thermal Resistance Junction-case Max.    | 0.57        | 2.9  | °C/W |

**Electrical Characteristics (T<sub>J</sub>=25°C , unless otherwise noted)**

| Symbol              | Parameter                         | Conditions   | Min. | Typ. | Max. | Unit |
|---------------------|-----------------------------------|--|------|------|------|------|
| BV <sub>DSS</sub>   | Drain-Source Breakdown Voltage    | V <sub>GS</sub> =0V , I <sub>D</sub> =250uA              | 850  | ---  | ---  | V    |
| R <sub>DS(ON)</sub> | Static Drain-Source On-Resistance | V <sub>GS</sub> =10V , I <sub>D</sub> =10A               | ---  | 0.22 | 0.26 | Ω    |
| V <sub>GS(th)</sub> | Gate Threshold Voltage            | V <sub>GS</sub> =V <sub>DS</sub> , I <sub>D</sub> =250uA | 2    | ---  | 4    | V    |
| I <sub>DSS</sub>    | Drain-Source Leakage Current      | V <sub>DS</sub> =800V , V <sub>GS</sub> =0V              | ---  | ---  | 1    | uA   |
| I <sub>GSS</sub>    | Gate-Source Leakage Current       | V <sub>GS</sub> = ±30V , V <sub>DS</sub> =0V             | ---  | ---  | ±100 | nA   |
| g <sub>fs</sub>     | Forward Transconductance          | V <sub>DS</sub> =10V , I <sub>D</sub> =10A               | ---  | 15   | ---  | S    |
| R <sub>g</sub>      | Gate Resistance                   | V <sub>DS</sub> =0V , V <sub>GS</sub> =0V , f=1MHz       | ---  | 3    | ---  | Ω    |
| Q <sub>g</sub>      | Total Gate Charge                 | I <sub>D</sub> =17A                                      | ---  | 39   | ---  | nC   |
| Q <sub>gs</sub>     | Gate-Source Charge                | V <sub>DS</sub> =640V                                    | ---  | 7.3  | ---  |      |
| Q <sub>gd</sub>     | Gate-Drain Charge                 | V <sub>GS</sub> =10V                                     | ---  | 19.2 | ---  |      |
| T <sub>d(on)</sub>  | Turn-On Delay Time                | V <sub>DS</sub> =400V                                    | ---  | 28   | ---  | ns   |
| T <sub>r</sub>      | Rise Time                         | V <sub>GS</sub> =10V                                     | ---  | 50   | ---  |      |
| T <sub>d(off)</sub> | Turn-Off Delay Time               | I <sub>D</sub> =17A                                      | ---  | 129  | ---  |      |
| T <sub>f</sub>      | Fall Time                         | R <sub>G</sub> =25Ω                                      | ---  | 44   | ---  |      |
| C <sub>iss</sub>    | Input Capacitance                 | V <sub>DS</sub> =400V , V <sub>GS</sub> =0V , f=1MHz     | ---  | 1400 | ---  | pF   |
| C <sub>oss</sub>    | Output Capacitance                |  | ---  | 29.7 | ---  |      |
| C <sub>rss</sub>    | Reverse Transfer Capacitance      |  | ---  | 3.8  | ---  |      |

**Diode Characteristics**

| Symbol          | Parameter                 | Conditions   | Min. | Typ. | Max. | Unit |
|-----------------|---------------------------|--|------|------|------|------|
| I <sub>S</sub>  | Continuous Source Current | V <sub>G</sub> =V <sub>D</sub> =0V , Force Current | ---  | ---  | 19   | A    |
| I <sub>SM</sub> | Pulsed Source Current     |  | ---  | ---  | 76   | A    |
| V <sub>SD</sub> | Diode Forward Voltage     | V <sub>GS</sub> =0V , I <sub>S</sub> =10A          | ---  | 0.84 | 1.4  | V    |

Note :

1.The EAS data shows Max. rating .The test condition is V<sub>DS</sub>=100V , V<sub>GS</sub>=10V , L=30mH , I<sub>AS</sub>=1.4A.

This product has been designed and qualified for the consumer market.  
Cmos assumes no liability for customers' product design or applications.  
Cmos reserves the right to improve product design ,functions and reliability without notice.

Typical Characteristics

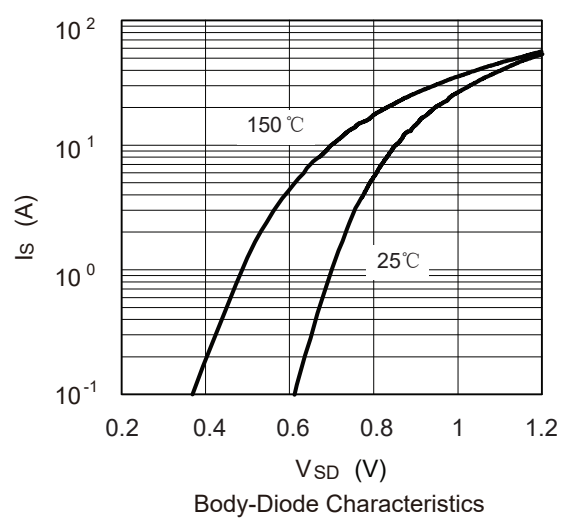
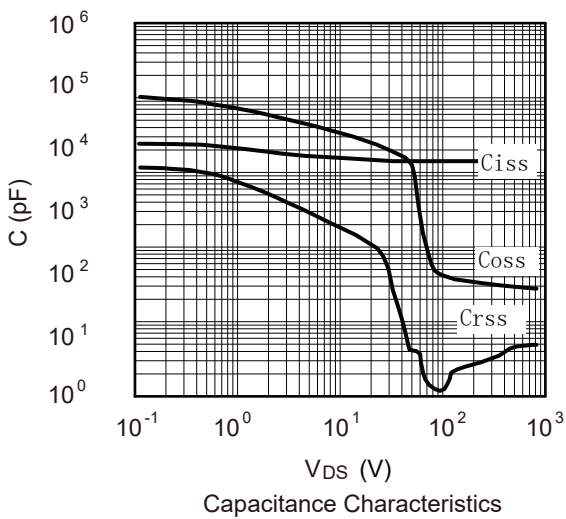
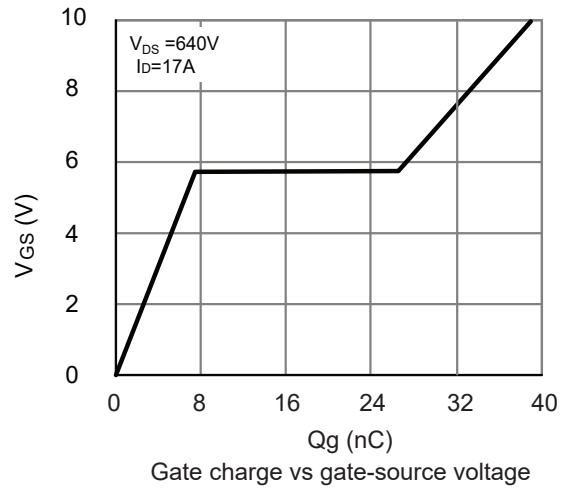
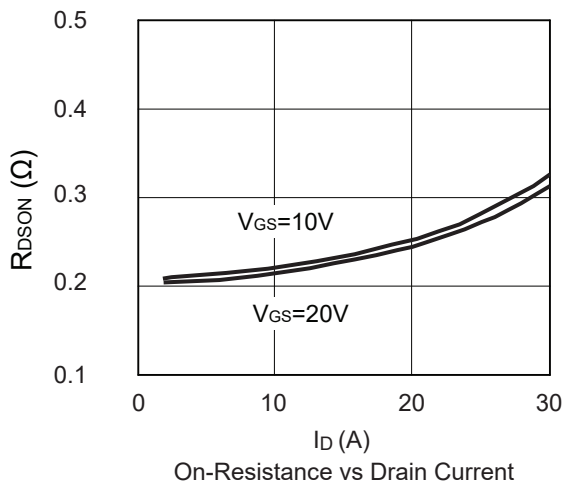
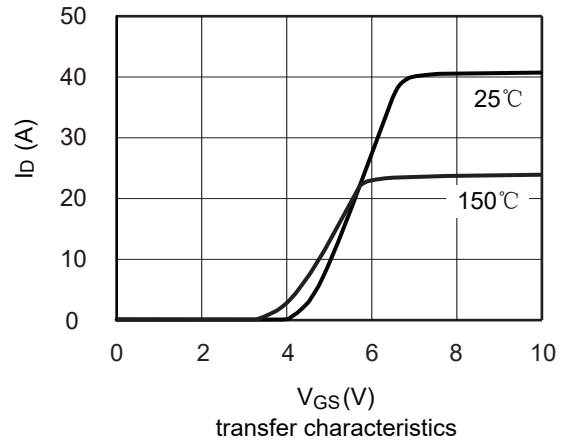
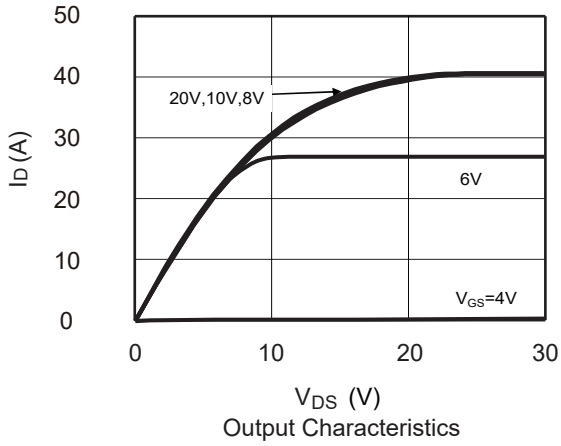

Package Dimension

TO-220

Unit :mm

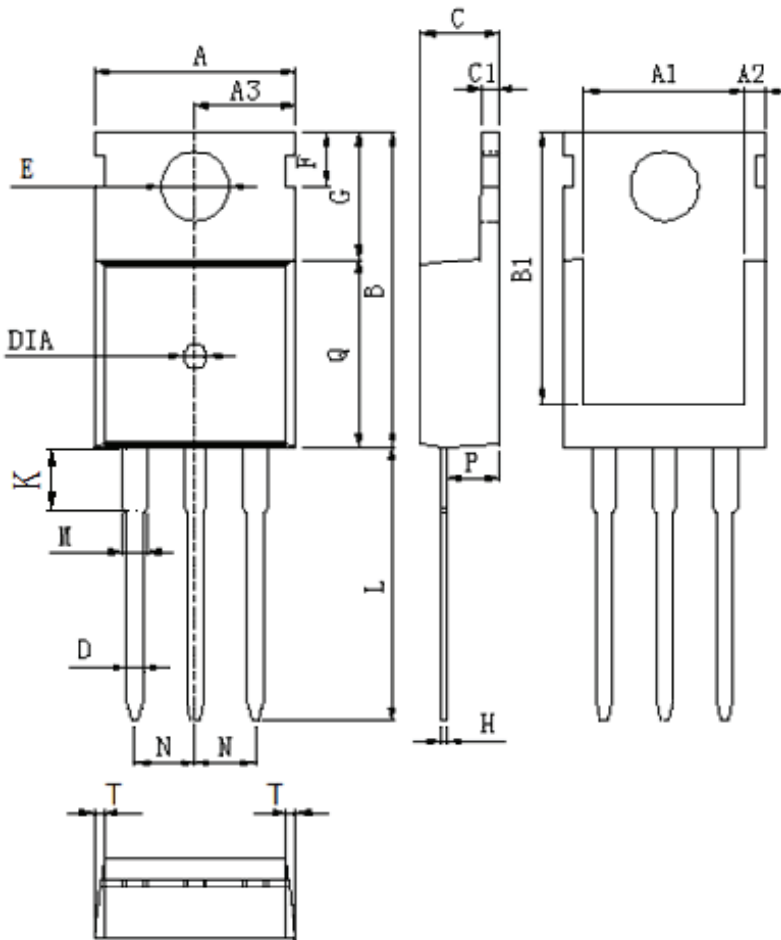

| DIM | MILLIMETERS    |
|-----|----------------|
| A   | 10.0±0.3       |
| A1  | 8.64±0.2       |
| A2  | 1.15±0.1       |
| A3  | 5.0±0.2        |
| B   | 15.8±0.4       |
| B1  | 13.2±0.3       |
| C   | 4.56±0.1       |
| C1  | 1.3±0.2        |
| D   | 0.8±0.2        |
| E   | 3.6±0.2        |
| F   | 2.95±0.3       |
| G   | 6.5±0.3        |
| H   | 0.5±0.1        |
| K   | 3.1±0.2        |
| L   | 13.2±0.4       |
| M   | 1.25±0.1       |
| N   | 2.54±0.1       |
| P   | 2.4±0.3        |
| Q   | 9.0±0.3        |
| T   | W:0.35         |
| DIA | ⊙1.5(deep 0.2) |

Package Dimension

TO-263

Unit :mm

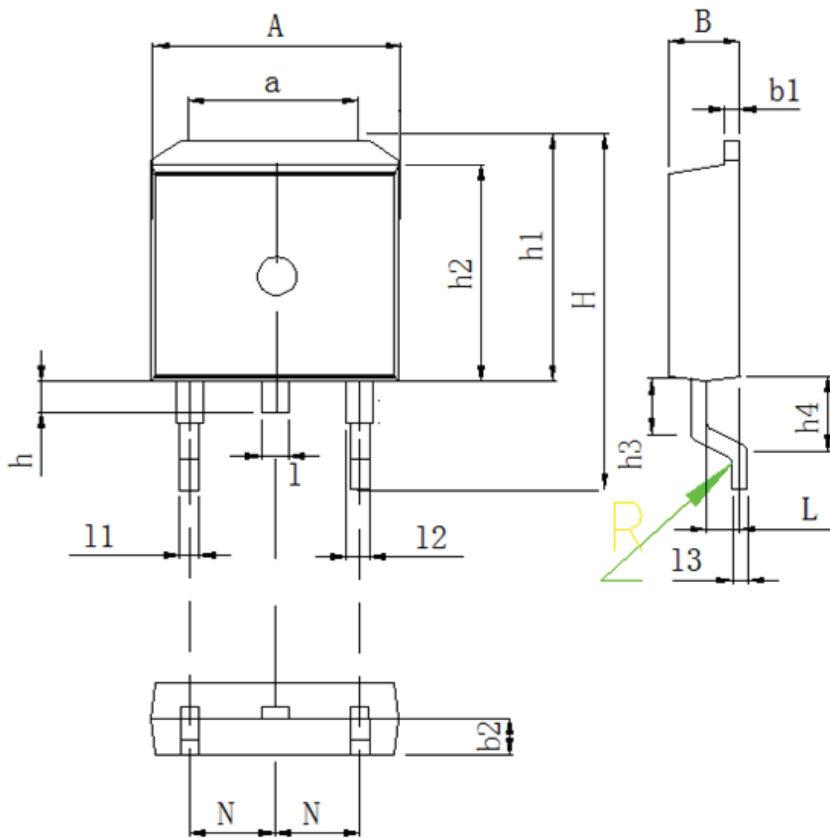

| DIM | MILLIMETERS |
|-----|-------------|
| A   | 9.8±0.2     |
| a   | 7.4±0.4     |
| B   | 4.5±0.2     |
| b1  | 1.3±0.05    |
| b2  | 2.4±0.2     |
| H   | 15.5±0.3    |
| h   | 1.54±0.2    |
| h1  | 10.5±0.2    |
| h2  | 9.2±0.1     |
| h3  | 1.54±0.2    |
| h4  | 2.7±0.2     |
| L   | 2.4±0.2     |
| 1   | 1.3±0.1     |
| 11  | 0.8±0.1     |
| 12  | 1.3±0.1     |
| 13  | 0.5±0.1     |
| N   | 2.54±0.1    |
| R   | 0.5R±0.05   |

Package Dimension

TO-262

Unit :mm

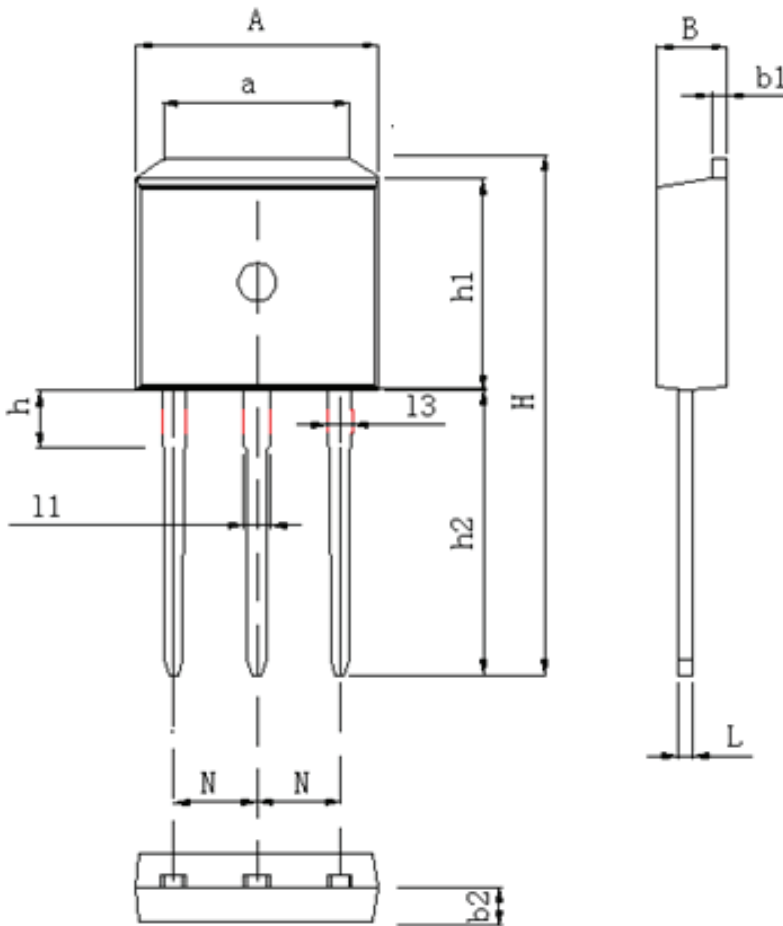

| DIM | MILLIMETERS    |
|-----|----------------|
| A   | $9.98 \pm 0.2$ |
| a   | $7.4 \pm 0.4$  |
| B   | $4.5 \pm 0.2$  |
| b1  | $1.3 \pm 0.05$ |
| b2  | $2.4 \pm 0.2$  |
| H   | $23.9 \pm 0.3$ |
| h   | $3.1 \pm 0.2$  |
| h1  | $9.16 \pm 0.2$ |
| h2  | $13.2 \pm 0.2$ |
| L   | $0.5 \pm 0.1$  |
| l1  | $1.3 \pm 0.1$  |
| l2  | $0.8 \pm 0.1$  |
| N   | $2.45 \pm 0.1$ |

Package Dimension

TO-220F

Unit :mm

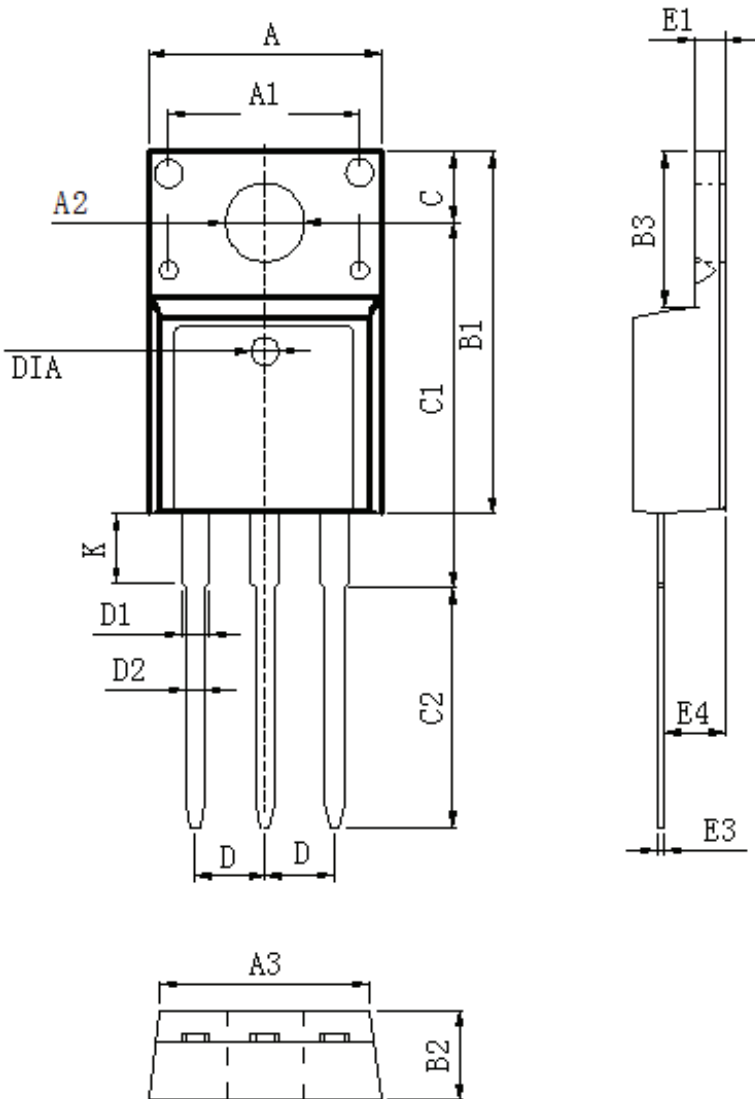

| DIM | MILLIMETERS     |
|-----|-----------------|
| A   | 10.16±0.3       |
| A1  | 7.00±0.1        |
| A2  | 3.3±0.2         |
| A3  | 9.5±0.2         |
| B1  | 15.87±0.3       |
| B2  | 4.7±0.2         |
| B3  | 6.68±0.4        |
| C   | 3.3±0.2         |
| C1  | 12.57±0.3       |
| C2  | 10.02±0.5       |
| D   | 2.54±0.05       |
| D1  | 1.28±0.2        |
| D2  | 0.8±0.1         |
| K   | 3.1±0.3         |
| E1  | 2.54±0.1        |
| E3  | 0.5±0.1         |
| E4  | 2.76±0.2        |
| DIA | ⊙1.5 (deep 0.2) |