

Features

- Constant Voltage Control
- Wide Voltage Range Selection 2.4V To 75V
- SOD323-GW Thin SMD package
- RoHS Compliant / Green EMC/Pb Free
- Matte Tin (Sn) Lead Finish
- Device marking: Refer to table list
- Complies with the standards of AEC-Q101
- Moisture Sensitivity Level (MSL 1)

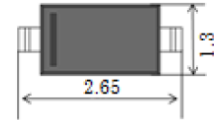

SOD323-GW



Maximum Ratings(Ta=25°C)

Symbol	Parameter	Value	Units
P _D	Power Dissipation	300(*)	mW
T _J	Junction Temperature	150	°C
R _{θJC(Top)}	Junction-to-case(top) Thermal Resistance	265	°C/W
T _{STG}	Storage Temperature	-55 to+125	°C
I _{ZM}	Maximum Regulator Current	P _D /V _Z	mA
V _F	Maximum Instantaneous Forward Voltage at 10mA	0.9	V

Note*: Mounted on ceramic substrate with FR-4 1CM² PCB Board.

Electrical Characteristics (T =25°C unless otherwise noted)

Type Number	Device Marking	V _Z (V) (Note1)			I _{ZT} mA	Z _{ZT} @ I _{ZT}	Z _{ZK} @ I _{ZK}	I _{ZK} (mA)	I _R (μA)	V _R (V)
		Nom(V)	Min(V)	Max(V)		Ω				
SZT52C2V4S-AT	WX	2.4	2.28	2.52	5	100	600	1.0	50	1.0
SZT52C2V7S-AT	W1	2.7	2.57	2.84	5	100	600	1.0	20	1.0
SZT52C3V0S-AT	W2	3.0	2.85	3.15	5	95	600	1.0	10	1.0
SZT52C3V3S-AT	W3	3.3	3.14	3.47	5	95	600	1.0	5	1.0
SZT52C3V6S-AT	W4	3.6	3.42	3.78	5	90	600	1.0	5	1.0
SZT52C3V9S-AT	W5	3.9	3.71	4.10	5	90	600	1.0	3	1.0
SZT52C4V3S-AT	W6	4.3	4.09	4.52	5	90	600	1.0	3	1.0
SZT52C4V7S-AT	W7	4.7	4.47	4.94	5	80	500	1.0	3	2.0
SZT52C5V1S-AT	W8	5.1	4.85	5.36	5	60	480	1.0	2	2.0
SZT52C5V6S-AT	W9	5.6	5.32	5.88	5	40	400	1.0	1	2.0
SZT52C6V2S-AT	WA	6.2	5.89	6.51	5	10	150	1.0	3	4.0
SZT52C6V8S-AT	WB	6.8	6.46	7.14	5	15	80	1.0	2	4.0

Type Number	Device Marking	V _z (V) (Note1)			I _{ZT} mA	Z _{ZT} @ I _{ZT}	Z _{ZK} @ I _{ZK}	I _{ZK} (mA)	I _R (μA)	V _R (V)
		Nom(V)	Min(V)	Max(V)		Ω				
SZT52C7V5S-AT	WC	7.5	7.13	7.88	5	15	80	1.0	1	5.0
SZT52C8V2S-AT	WD	8.2	7.79	8.61	5	15	80	1.0	0.7	5.0
SZT52C9V1S-AT	WE	9.1	8.65	9.56	5	15	100	1.0	0.5	6.0
SZT52C10S-AT	WF	10.0	9.50	10.50	5	20	150	1.0	0.2	7.0
SZT52C11S-AT	WG	11.0	10.45	11.55	5	20	150	1.0	0.1	8.0
SZT52C12S-AT	WH	12.0	11.40	12.60	5	25	150	1.0	0.1	8.0
SZT52C13S-AT	WI	13.0	12.35	13.65	5	30	170	1.0	0.1	8.0
SZT52C14S-AT	WY	14	13.30	14.70	5	25	110	1.0	0.1	10.5
SZT52C15S-AT	WJ	15.0	14.25	15.75	5	30	200	1.0	0.1	10.5
SZT52C16S-AT	WK	16.0	15.20	16.80	5	40	200	1.0	0.1	11.2
SZT52C18S-AT	WL	18.0	17.10	18.90	5	45	225	1.0	0.1	12.6
SZT52C20S-AT	WM	20.0	19.00	21.00	5	55	225	1.0	0.1	14.0
SZT52C22S-AT	WN	22.0	20.90	23.10	5	55	250	1.0	0.1	15.4
SZT52C24S-AT	WO	24.0	22.80	25.20	5	70	250	1.0	0.1	16.8
SZT52C27S-AT	WP	27.0	25.65	28.35	2	80	300	0.5	0.1	18.9
SZT52C30S-AT	WQ	30.0	28.50	31.50	2	80	300	0.5	0.1	21.0
SZT52C33S-AT	WR	33.0	31.35	34.65	2	80	325	0.5	0.1	23.1
SZT52C36S-AT	WS	36.0	34.20	37.80	2	90	350	0.5	0.1	25.2
SZT52C39S-AT	WT	39.0	37.05	40.95	2	130	350	0.5	0.1	27.3
SZT52C43S-AT	WU	43.0	40.85	45.15	2	150	375	0.5	0.05	30.1
SZT52C47S-AT	WV	47.0	44.65	49.35	2	170	1000	0.25	0.1	36
SZT52C51S-AT	X1	51	48.45	53.55	2	180	1300	0.25	0.1	39
SZT52C56S-AT	X2	56	53.20	58.80	2	200	1400	0.25	0.1	43
SZT52C62S-AT	X3	62	58.90	65.10	2	225	1400	0.25	0.1	47
SZT52C68S-AT	X4	68	64.60	71.40	2	240	1600	0.25	0.1	52
SZT52C75S-AT	X5	75	71.25	78.75	2	265	1700	0.25	0.1	56

Note 1: Pulse width = 10 ms

VF Forward Voltage=900mV Maximum@IF=10Ma for all types



Typical Characteristics

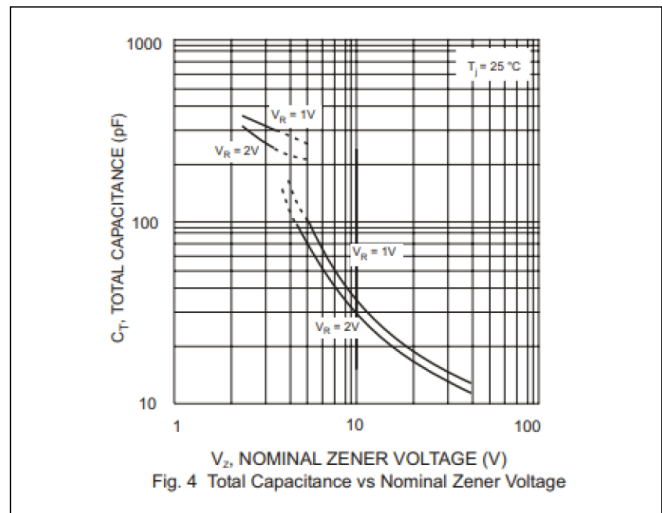
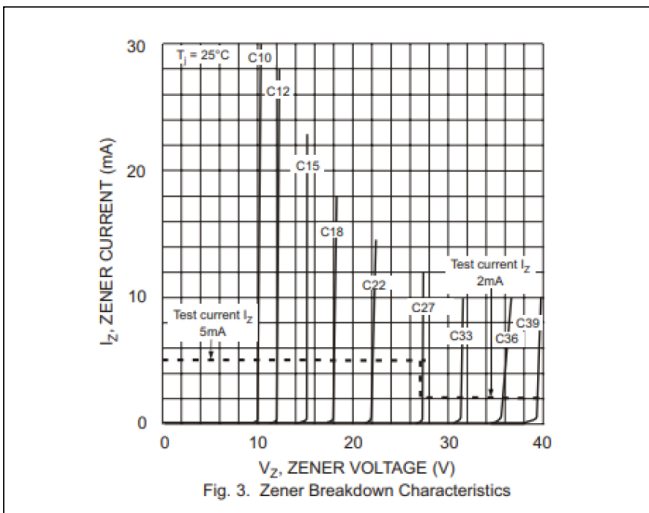
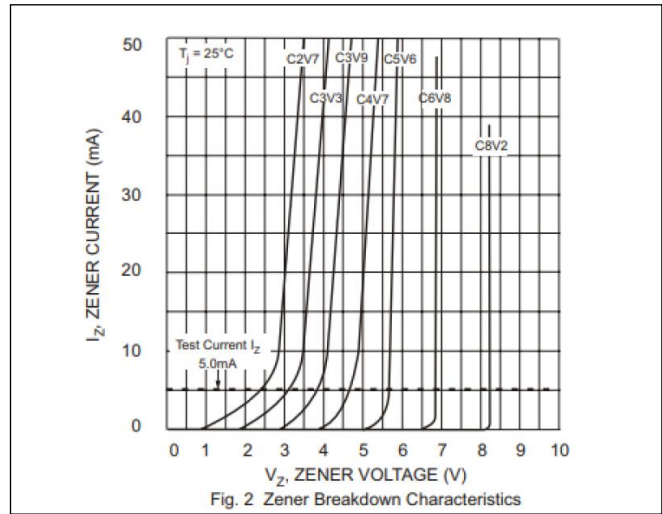
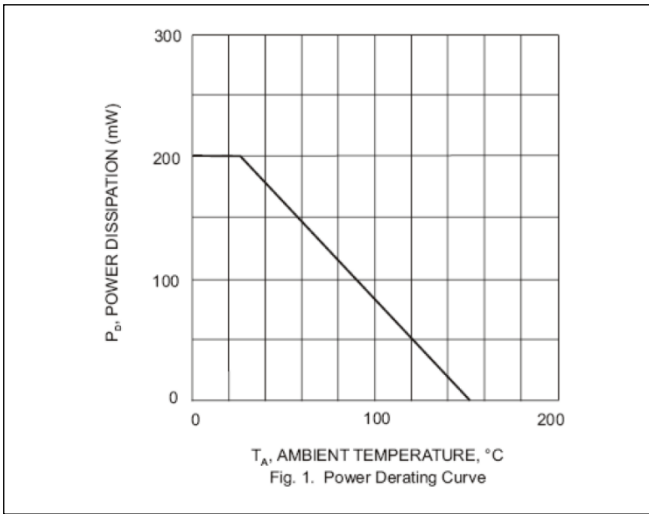



Reflow Profile

Reflow Condition		Lead-free assembly
Pre Heat	- Temperature Min ($T_{s(min)}$)	150°C
	- Temperature Max ($T_{s(max)}$)	200°C
	- Time (min to max) (t_s)	60 – 180 secs
Average ramp up rate (Liquidus Temp (T_L) to peak)		3°C/second max
$T_{s(max)}$ to T_L - Ramp-up Rate		3°C/second max
Reflow	- Temperature (T_A) (Liquidus)	217°C
	- Time (min to max) (t_r)	60 – 150 seconds
Peak Temperature (T_p)		260 ^{+0/-5} °C
Time within 5°C of actual peak Temperature (t_p)		20 – 40 seconds
Ramp-down Rate		6°C/second max
Time 25°C to peak Temperature (T_p)		8 minutes Max.
Do not exceed		260°C

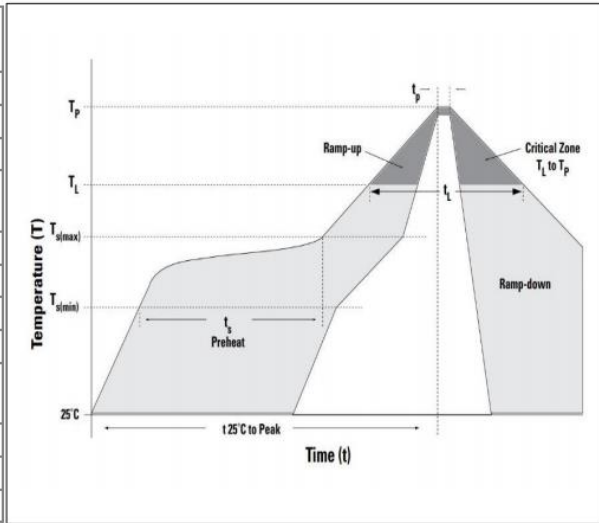

Ordering Information

Device	Package	Shipping	Tape wide	Emboss pitch	Tape specification	Notes
SZT52CXXS Series	SOD323-GW	Tape & Reel 3000pcs /7" Reel	8 mm	4 mm	Conductive	

Package Dimensions

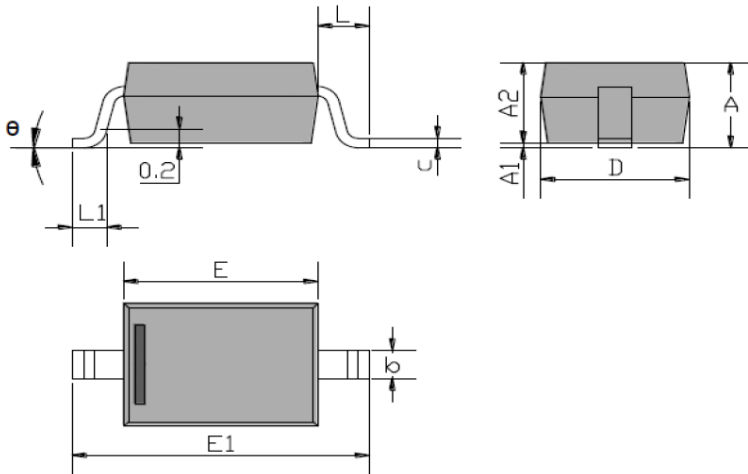

Symbol	Dimensions in mm	
	Min	Max
A		1.000
A1	0.000	0.100
A2	0.800	0.900
b	0.250	0.350
c	0.080	0.150
D	1.200	1.400
E	1.600	1.800
E1	2.500	2.700
L	0.475REF	
L1	0.250	0.400
θ	0°	8°

Note:

- 1 Halogen free, EMC
- 2 Pb free
- 3 Lead thickness includes solder plating
- 4 Lead frame: A42
- 5 Other Tolerance: ± 0.05
- 6 Dimensions are exclusive of Burrs, Mold Flash and Tie Bar extrusions
- 7 Unit: mm



Part Numbering

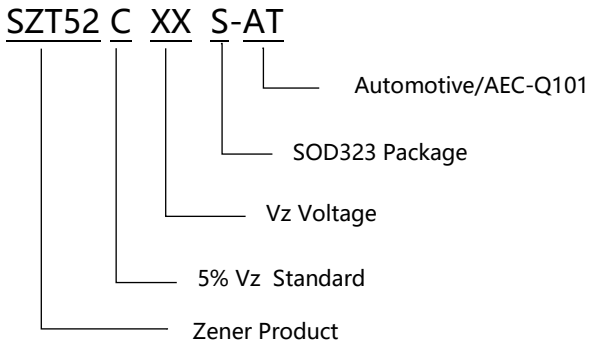

Revision history of Specification

Version	Change Items	Effective Date
1.0	Initial Release	13-July-2022
1.1	Add New Voltage Products	13- Oct-2023
1.2	Upgrade MSL、 V_F 、 P_D & $R_{\theta jc}$;Add Reflow profile	10-Feb-2024