

Features

- Planar Die Construction
- 350mw Power Dissipation
- Zener Voltages From 2.4V-75V
- Rohs Compliant / Green EMC
- AEC-Q101 Qualified

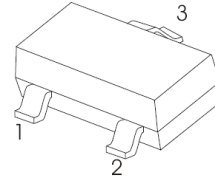

SOT-23

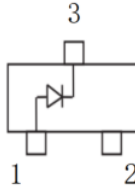

Maximum Ratings(Ta=25°C)

Symbol	Parameter	Value	Units
V _F	Maximum Forward Voltage @ I _F =10mA	0.9	V
P _D	Power Dissipation	350	mW
T _J	Junction Temperature	150	°C
T _{STG}	Storage Temperature	-55 to +150	°C
I _{FSM}	Peak Forward Surge Current	2.0	A
R _{θJA}	Thermal Resistance Junction to Ambient	357	°C/W
ΔV _Z	V _Z Temperature Variation Coefficient	5.7	mV/°C

Electrical Characteristics (T =25°C unless otherwise noted)

Type Number	Device Marking	V _Z (V) (Note1)			I _{ZT} mA	Z _{ZT} @ I _{ZT}	Z _{ZK} @ I _{ZK}	I _{ZK} (mA)	I _R (uA)	V _R (V)
		Nom(V)	Min(V)	Max(V)		Ω				
SZX84C2V4-AT	Z11.	2.28	2.4	2.52	5	100	600	1	50	1
SZX84C2V7-AT	W2.	2.5	2.7	2.9	5	100	600	1	20	1
SZX84C3V0-AT	Z13.	2.8	3	3.2	5	95	600	1	10	1
SZX84C3V3-AT	Z14.	3.1	3.3	3.5	5	95	600	1	5	1
SZX84C3V6-AT	Z15.	3.4	3.6	3.8	5	90	600	1	5	1
SZX84C3V9-AT	Z16.	3.7	3.9	4.1	5	90	600	1	3	1
SZX84C4V3-AT	Z17.	4	4.3	4.6	5	90	600	1	3	1
SZX84C4V7-AT	Z1.	4.4	4.7	5	5	80	500	1	3	2
SZX84C5V1-AT	Z2.	4.8	5.1	5.4	5	60	480	1	2	2
SZX84C5V6-AT	Z3.	5.2	5.6	6	5	40	400	1	1	2
SZX84C6V2-AT	Z4.	5.8	6.2	6.6	5	10	150	1	3	4
SZX84C6V8-AT	Z5.	6.4	6.8	7.2	5	15	80	1	2	4
SZX84C7V5-AT	Z6.	7	7.5	7.9	5	15	80	1	1	5
SZX84C8V2-AT	Z7.	7.7	8.2	8.7	5	15	80	1	0.7	5
SZX84C9V1-AT	Z8.	8.5	9.1	9.6	5	15	100	1	0.5	6
SZX84C10-AT	Z9.	9.4	10	10.6	5	20	150	1	0.2	7
SZX84C11-AT	Y1.	10.4	11	11.6	5	20	150	1	0.1	8
SZX84C12-AT	Y2.	11.4	12	12.7	5	25	150	1	0.1	8
SZX84C13-AT	Y3.	12.4	13	14.1	5	30	170	1	0.1	8
SZX84C15-AT	Y4.	13.8	15	15.6	5	30	200	1	0.1	10.5
SZX84C16-AT	Y5.	15.3	16	17.1	5	40	200	1	0.1	11.2
SZX84C18-AT	Y6.	16.8	18	19.1	5	45	225	1	0.1	12.6
SZX84C20-AT	Y7.	18.8	20	21.2	5	55	225	1	0.1	14
SZX84C22-AT	Y8.	20.8	22	23.3	5	55	250	1	0.1	15.4
SZX84C24-AT	Y9.	22.8	24	25.6	5	70	250	1	0.1	16.8
SZX84C27-AT	Y10.	25.1	27	28.9	2	80	300	1	0.1	18.9
SZX84C30-AT	Y11.	28	30	32	2	80	300	1	0.1	21
SZX84C33-AT	Y12.	31	33	35	2	80	325	1	0.1	23.1
SZX84C36-AT	Y13.	34	36	38	2	90	350	1	0.1	25.2
SZX84C39-AT	Y14.	37	39	41	2	130	350	1	0.1	27.3
SZX84C43-AT	Y15.	40.85	43	45.15	2	150	375	1	0.1	30.1



Type Number	Device Marking	V_z (V) (Note1)			I_{ZT} mA	$Z_{ZT}@I_{ZT}$ Ω	$Z_{ZK}@I_{ZK}$ Ω	I_{zk} (mA)	I_R (μ A)	V_R (V)
		Nom(V)	Min(V)	Max(V)						
SZX84C47-AT	Y16.	44.65	47	49.35	2	170	0.5	375	0.1	32.9
SZX84C51-AT	Y17.	48.45	51	53.55	2	180	0.5	400	0.1	35.7
SZX84C62-AT	Y19.	58.9	62	65.1	2	215	0.5	450	0.05	43.4
SZX84C68-AT	Y20.	64.6	68	71.4	2	240	0.5	1600	0.1	47.6
SZX84C75-AT	Y21.	71.25	75	78.75	2	255	0.5	1700	0.1	52.5

Note 1: Pulse width = 10 ms



Typical Characteristics

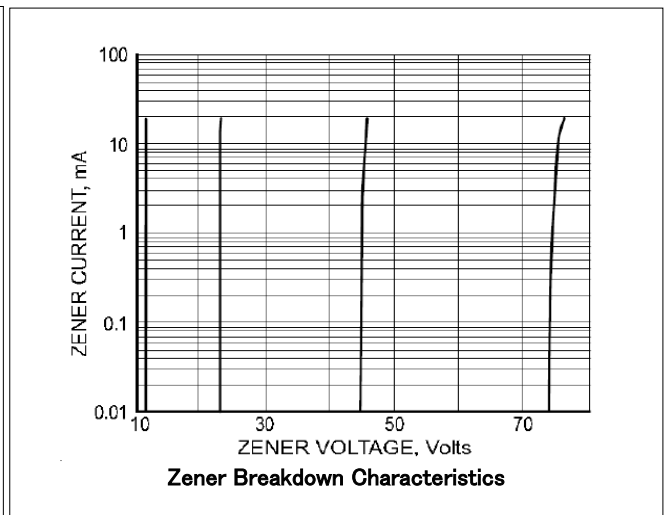
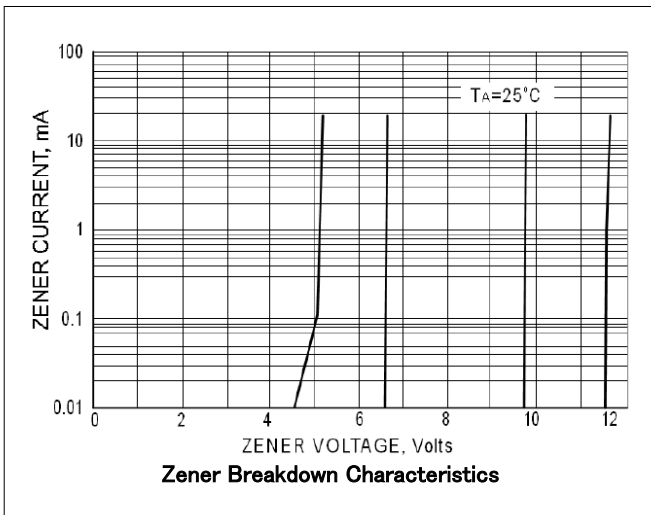
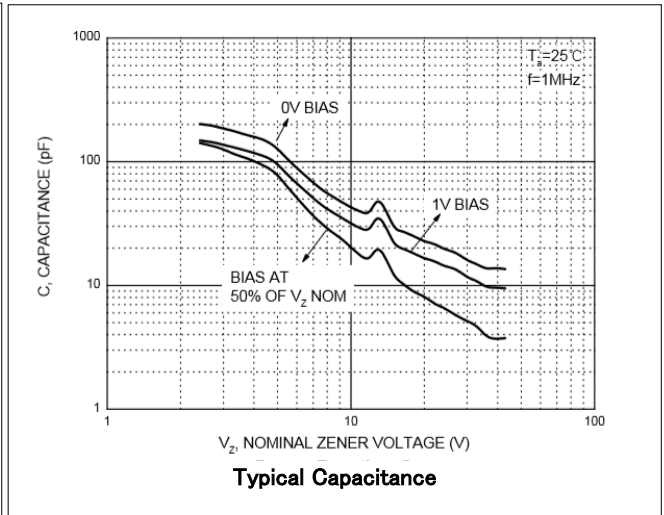
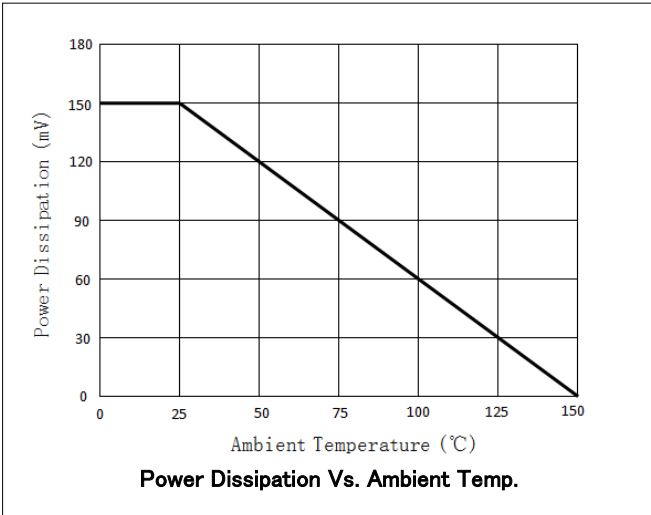
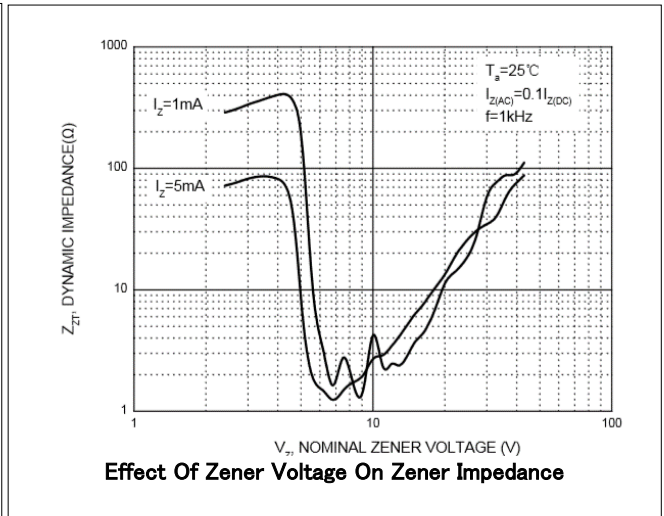
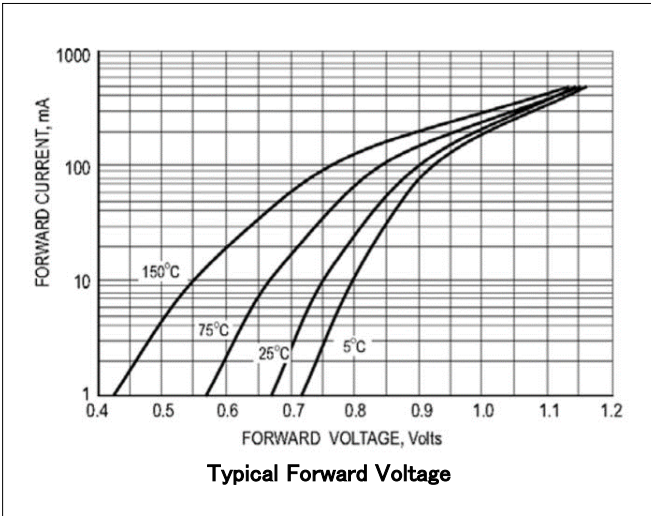

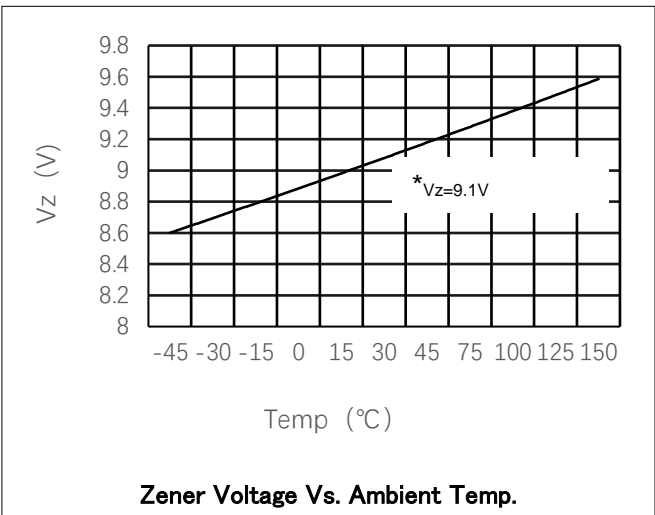
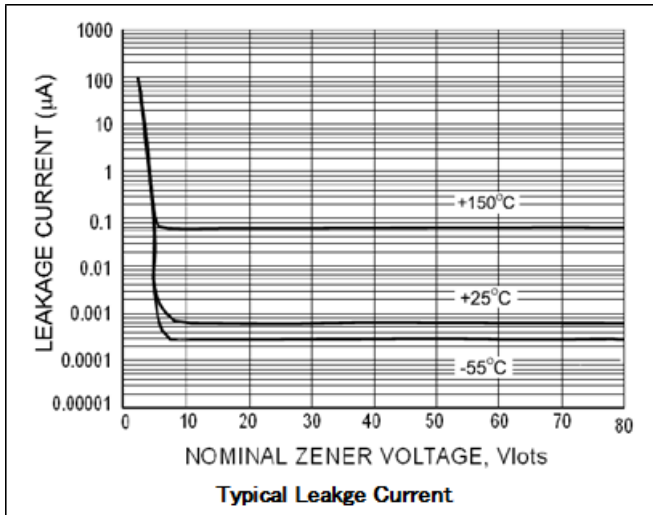

Ordering Information

Device	Package	Shipping	Tape wide	Emboss pitch	Tape specification	Notes
SZX84C-AT Series	SOT-23	Tape & Reel 3000pcs /7" Reel	8 mm	4 mm	Conductive	

Package Dimensions

Package outline :SOT-23

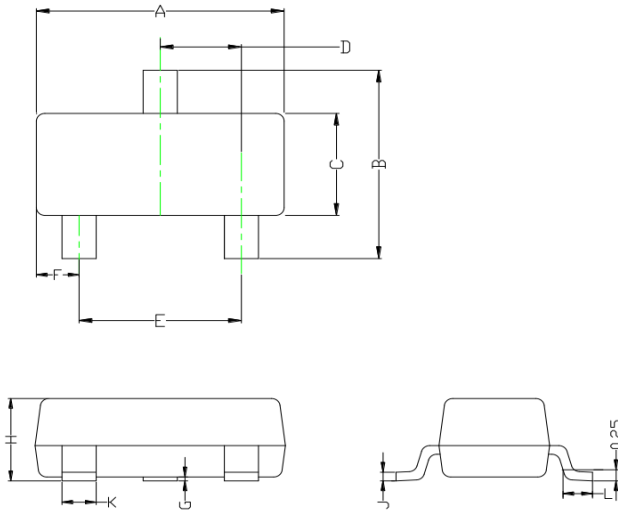

Symbol	Dimensions in mm	
	Min.	Max.
A	2.800	3.040
B	2.100	2.640
C	1.200	1.400
D	0.890	1.030
E	1.780	2.050
F	0.450	0.600
G	0.013	0.100
H	0.900	1.110
J	0.085	0.180
K	0.370	0.510
L	0.300	0.500

Land Pattern Recommendation

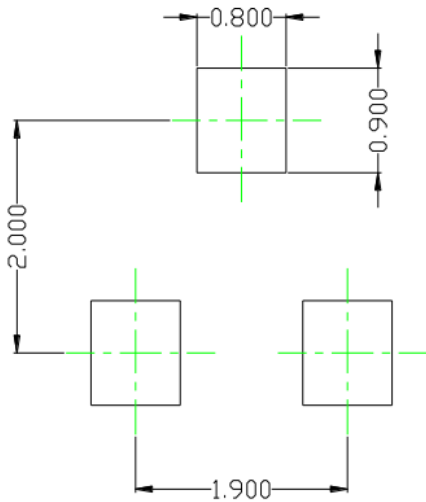

Notice:

1. Lead plating: Pb free solder
2. Lead thickness includes solder plating
3. Lead frame: CAC-5
4. Other Tolerance: ± 0.05

Revision history of Specification

Version	Change Items	Effective Date
1.0	Initial Release	15-Aug-2023
1.1	Add ΔV_z Parameters And Graphs	18-Mar-2024