

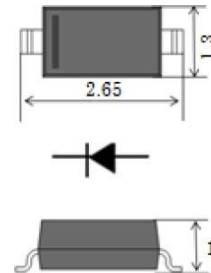

Features

- Constant Voltage control
- Wide Voltage Range Selection 2.4V to 75V
- Package : SOD-323
- RoHS compliant/Green EMC
- Matte Tin(Sn) Lead finish
- Cathode Band/Device marking
Refer to table list
- Complies with the standards of AEC-Q101
- Moisture Sensitivity Level (MSL 1)



Maximum Ratings (Ta=25°C)

Symbol	Parameter	Value	Units
P _C	Collector Power Dissipation ^{NOTE1}	300	mW
T _J	Junction Temperature	150	°C
T _{STG}	Storage Temperature	-65 to +150	°C
I _{ZM}	Maximum Regulator Current	P _D /V _Z	mA
R _{θJA}	Thermal Resistance, Junction to Ambient	500	°C/W

NOTE: 1 、 Device mounted on an FR4 PCB, single-sided copper, tin-plated and standard footprint.

Electrical Characteristics (T =25°C unless otherwise noted)

Type Number	Device Marking	Vz (V) (Note 1)			I _{ZT} mA	Z _{ZT} @I _{ZT}	Z _{ZK} @I _{ZK}	I _{ZK} (mA)	I _R (μ A)	V _R (V)
		Nom(V)	Min(V)	Max(V)		Ω				
SZT52B2V4S-AT	2WX	2.4	2.35	2.45	5	100	600	1.0	50	1.0
SZT52B2V7S-AT	2W1	2.7	2.65	2.75	5	100	600	1.0	20	1.0
SZT52B3V0S-AT	2W2	3.0	2.94	3.06	5	95	600	1.0	10	1.0
SZT52B3V3S-AT	2W3	3.3	3.23	3.37	5	95	600	1.0	5	1.0
SZT52B3V6S-AT	2W4	3.6	3.53	3.67	5	90	600	1.0	5	1.0
SZT52B3V9S-AT	2W5	3.9	3.82	3.98	5	90	600	1.0	3	1.0
SZT52B4V3S-AT	2W6	4.3	4.21	4.39	5	90	600	1.0	3	1.0
SZT52B4V7S-AT	2W7	4.7	4.61	4.79	5	80	500	1.0	3	2.0
SZT52B5V1S-AT	2W8	5.1	5.00	5.20	5	60	480	1.0	2	2.0
SZT52B5V6S-AT	2W9	5.6	5.49	5.71	5	40	400	1.0	1	2.0
SZT52B6V2S-AT	2WA	6.2	6.08	6.32	5	10	150	1.0	3	4.0
SZT52B6V8S-AT	2WB	6.8	6.66	6.94	5	15	80	1.0	2	4.0
SZT52B7V5S-AT	2WC	7.5	7.35	7.65	5	15	80	1.0	1	5.0
SZT52B8V2S-AT	2WD	8.2	8.04	8.36	5	15	80	1.0	0.7	5.0
SZT52B9V1S-AT	2WE	9.1	8.92	9.28	5	15	100	1.0	0.5	6.0
SZT52B10S-AT	2WF	10	9.80	10.20	5	20	150	1.0	0.2	7.0
SZT52B11S-AT	2WG	11	10.78	11.22	5	20	150	1.0	0.1	8.0
SZT52B12S-AT	2WH	12	11.76	12.24	5	25	150	1.0	0.1	8.0
SZT52B13S-AT	2WI	13	12.74	13.26	5	30	170	1.0	0.1	8.0
SZT52B14S-AT	2WY	14	13.72	14.28	5	25	110	1.0	0.1	10.5
SZT52B15S-AT	2WJ	15	14.70	15.30	5	30	200	1.0	0.1	10.5
SZT52B16S-AT	2WK	16	15.68	16.32	5	40	200	1.0	0.1	11.2
SZT52B18S-AT	2WL	18	17.64	18.36	5	45	225	1.0	0.1	12.6
SZT52B20S-AT	2WM	20	19.60	20.40	5	55	225	1.0	0.1	14.0
SZT52B22S-AT	2WN	22	21.56	22.44	5	55	250	1.0	0.1	15.4
SZT52B24S-AT	2WO	24	23.52	24.48	5	70	250	1.0	0.1	16.8
SZT52B27S-AT	2WP	27	26.46	27.54	2	80	300	0.5	0.1	18.9
SZT52B30S-AT	2WQ	30	29.40	30.60	2	80	300	0.5	0.1	21.0
SZT52B33S-AT	2WR	33	32.34	33.66	2	80	325	0.5	0.1	23.1
SZT52B36S-AT	2WS	36	35.28	36.72	2	90	350	0.5	0.1	25.2
SZT52B39S-AT	2WT	39	38.22	39.78	2	130	350	0.5	0.1	27.3
SZT52B43S-AT	2WU	43	42.14	43.86	2	130	350	0.5	0.1	29.4
SZT52B47S-AT	2WV	47	45.83	48.17	2	170	1000	0.25	0.1	36
SZT52B51S-AT	2X1	51	49.73	52.27	2	180	1300	0.25	0.1	39
SZT52B56S-AT	2X2	56	54.60	57.40	2	200	1400	0.25	0.1	43
SZT52B62S-AT	2X3	62	60.45	63.55	2	225	1400	0.25	0.1	47
SZT52B68S-AT	2X4	68	66.30	69.70	2	240	1600	0.25	0.1	52
SZT52B75S-AT	2X5	75	73.13	76.87	2	265	1700	0.25	0.1	56

Note1:Pulse Width=10ms



Typical Characteristics

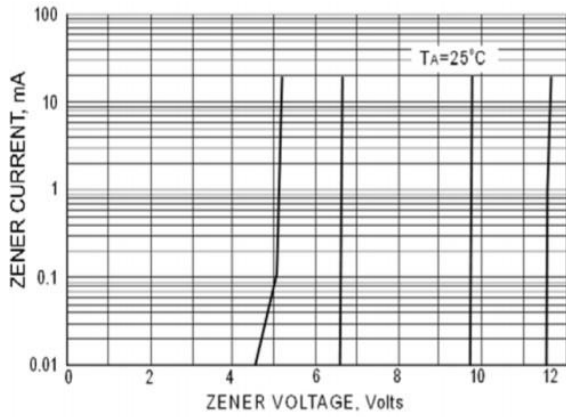

Zener Breakdown Characteristic

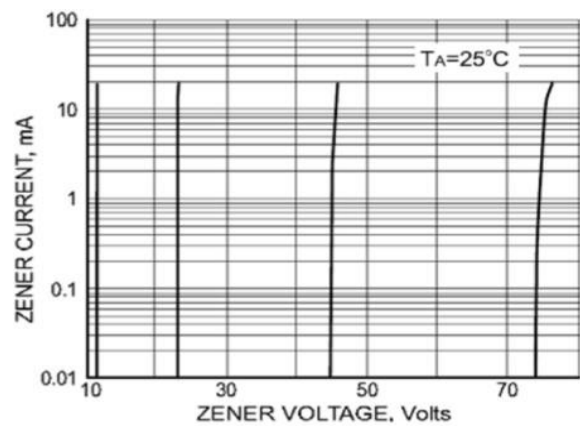

Zener Breakdown Characteristics

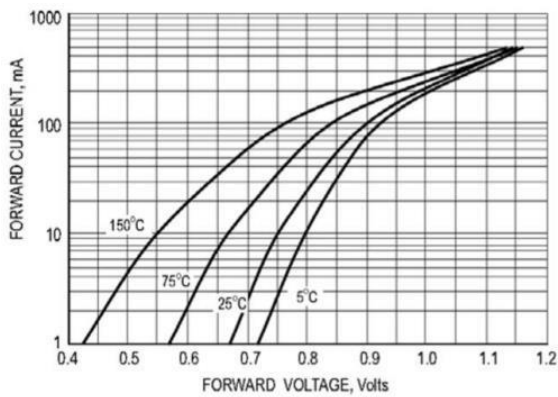

Typical Forward Voltage

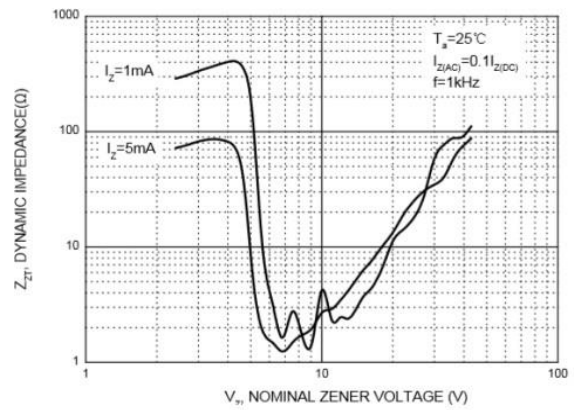

Effect of Zener Voltage on Zener Impedance

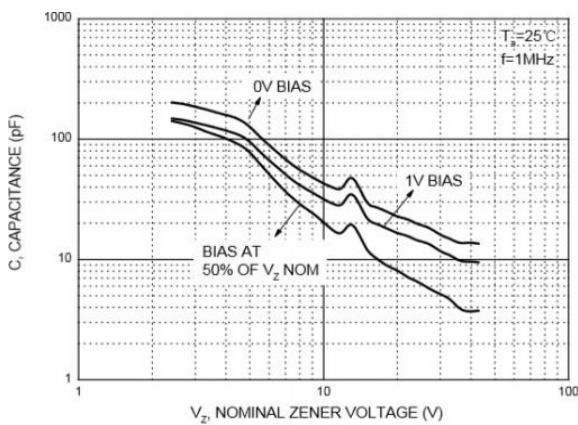

Typical Capacitance

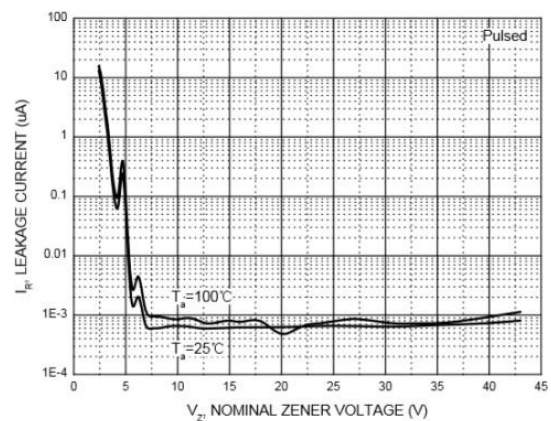

Typical Leakage Current

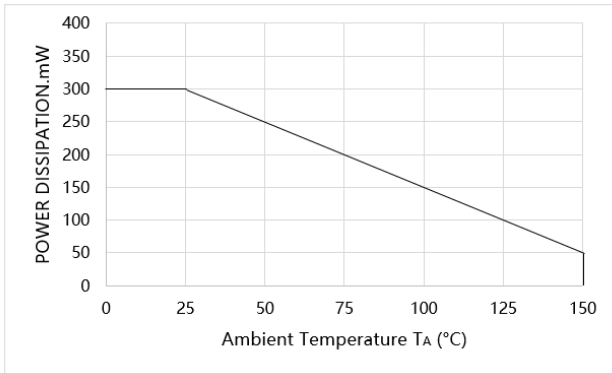

Power Dissipation Vs Ambient Temp

Reflow Profile

Reflow Condition		Lead-free assembly
Pre Heat	- Temperature Min ($T_{s(min)}$)	150°C
	- Temperature Max ($T_{s(max)}$)	200°C
	- Time (min to max) (t_i)	60 – 180 secs
Average ramp up rate (Liquidus Temp (T_A) to peak)		3°C/second max
$T_{s(max)}$ to T_A - Ramp-up Rate		3°C/second max
Reflow	- Temperature (T_A) (Liquidus)	217°C
	- Time (min to max) (t_i)	60 – 150 seconds
Peak Temperature (T_p)		260 ^{+0/-5} °C
Time within 5°C of actual peak Temperature (t_p)		20 – 40 seconds
Ramp-down Rate		6°C/second max
Time 25°C to peak Temperature (T_p)		8 minutes Max.
Do not exceed		260°C

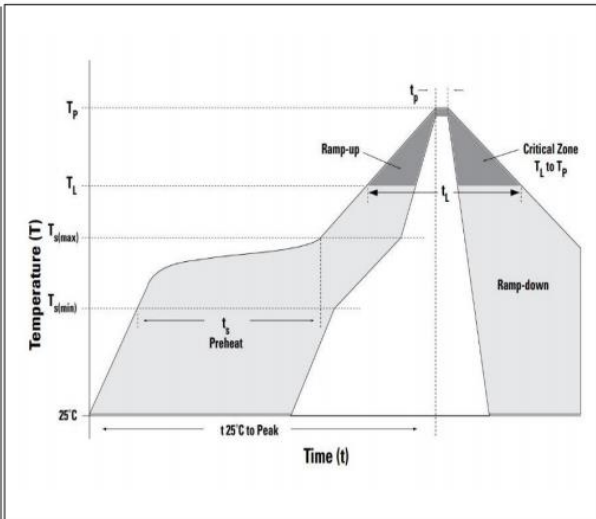

Order Information

Device	Package	Shipping	Tape wide	Emboss pitch	Tape specification	Notes
SZT52BXXS-AT Series	SOD323	Tape & Reel 3000pcs /7" Reel	8 mm	4 mm	Conductive	

Package Dimensions

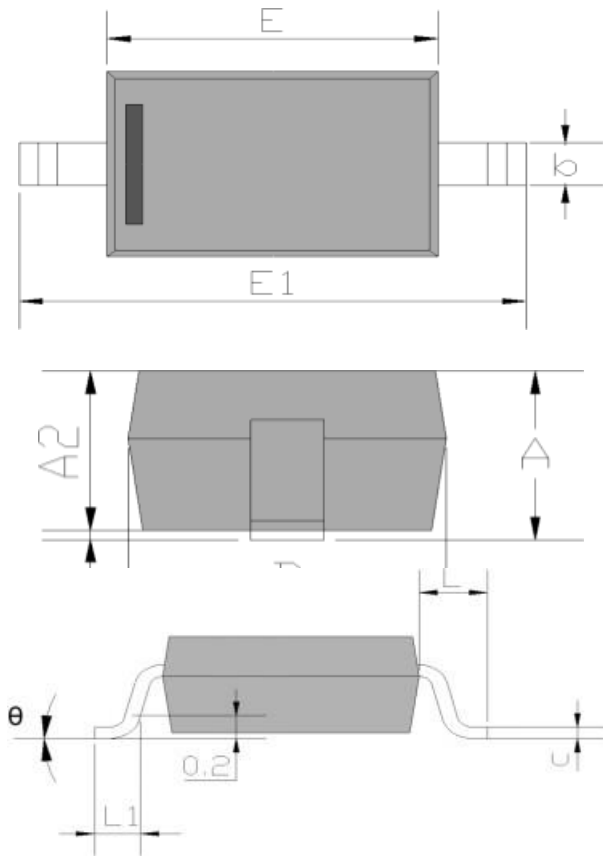

Symbol	Dimensions in mm	
	Min.	Max.
A		1.000
A1	0.000	0.100
A2	0.800	0.900
b	0.250	0.350
c	0.080	0.150
D	1.200	1.400
E	1.600	1.800
E1	2.500	2.700
L	0.475 REF.	
L1	0.250	0.400
θ	0°	8°

Part Numbering

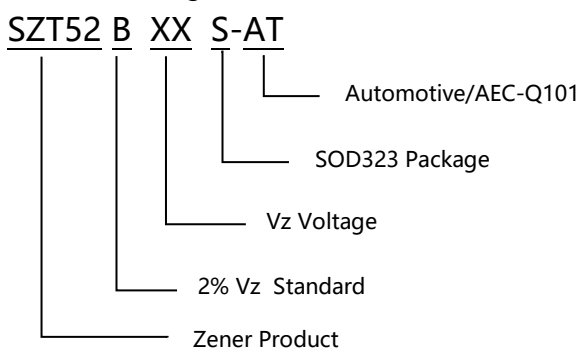

Revision history of Specification

Version	Change Items	Effective Date
1.0	Initial Release	13-July-2023