

HVR1A05-THT

- Hermetically sealed for long life
- Low Contact Resistance
- Excellent Lifetime Characteristics
- Custom Design Available

[Outline Dimension]

Unit: mm Scale: 1/1

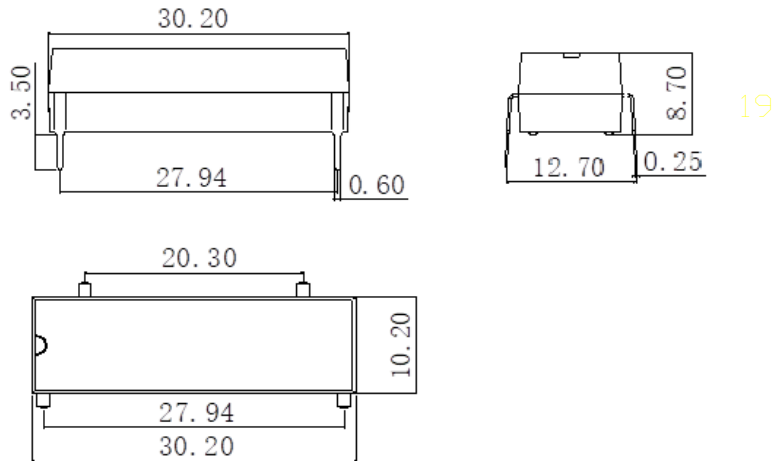

[Pin Layout]

[Wiring diagram]

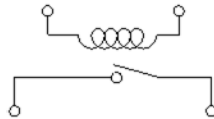

[PCB Layout Top View]

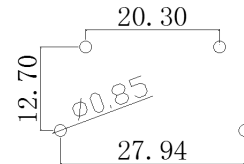

Coil Parameters		Relay Parameters	
1 Nominal coil voltage	5 VDC	1 Min Breakdown Voltage	4K VDC
2 Max Operating voltage	8 VDC	2 Dielectric Strength coil/contact	7K VDC
3 Max Pull-in voltage	3.75 VDC	3 Insulation Resistance coil/contact	1.00E+12ohm
4 Min Drop-out voltage	0.5 VDC	4 Operate Time, incl. Bounce	1.0ms
5 Coil Resistance	180 ohm	5 Reset Time	0.1ms
Contact Parameters		6 Capacitance Across Contacts	0.6pF
1 Contact Form	1 Form A	7 Storage Temperature	-40~+125°C
2 Max Contact Rating	100 W	8 Operating Temperature	-40~+100°C
3 Max Switch Voltage	1000V ACpeak/DC	9 Soldering Temperature	5 sec. max 260°C
4 Max Switch Current	1.0 A		
5 Max Carrying Current	2.5 A		
6 Min Breakdown Voltage	4K VDC		
7 Max Contact Resistance	150 mohm		

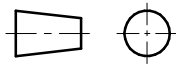
Version: 01	Designed by		TITLE	
	Checked by		High Voltage Reed Relay	
	Approved by		P/N	Scale: 1:1
	Date	12th,Jan,2024	HVR1A05-THT	Page: 1/1