

ROHS

REV	ECN NO	DESCRIPTION	DESIGN	APPROVAL	DATE
A1	NEW	Replace frame			2018.06.12

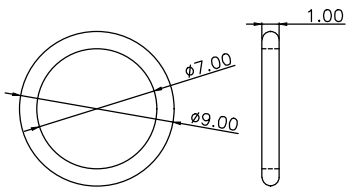

WHITE WATERPROOF RING

NOTES

- CURRENT RATING: 24V & 5A MAX.
- CONTACT RESISTANCE: 50mΩ MAX.
- INSULATION RESISTANCE: 100MΩ MIN.
- DIELECTRIC WITHSTANDING: 500V AC MIN.
- DURABILITY: 5000 CYCLES MIN.
- CONNECTOR MATING FORCES: 3~35N.
- CONNECTOR UNMATING FORCES: 3~35N.
- OPERATING TEMPERATURE: -25°C TO +85°C.
- WATER PROOFNESS: THIS PRODUCT IS BASED ON IPX7.

Not to install the waterproof ring shipment

9F W 5 152 A T F A

MODEL DEFINITION
 Mould Number:01
 Needle diameter:2.0
 Fixing Method:Fixing Column
 Interface Method:Convention Extended Opening
 Overall Length:15.25mm
 Pin Position:5PIN
 Mounting Method:DIP
 Product Series: DC Jack IPX7

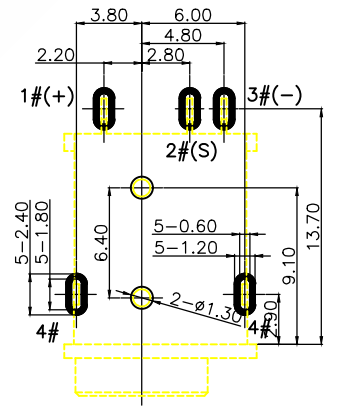
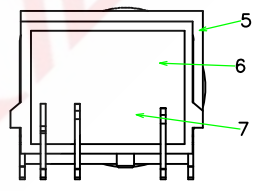
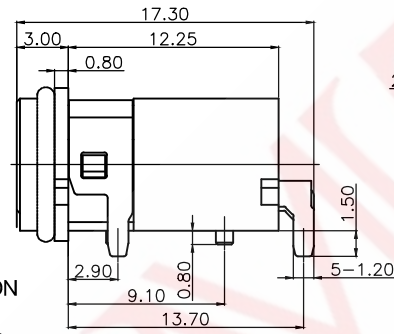
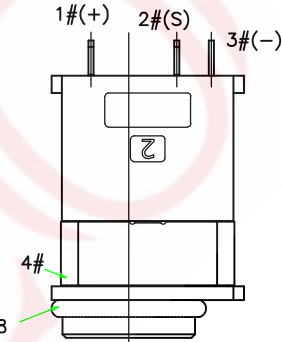
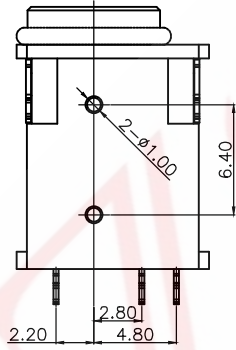
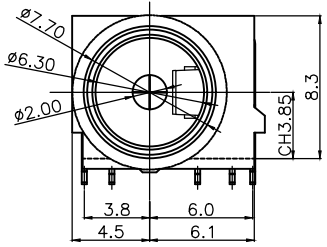

PCB LAYOUT (TOP VIEW)
TOLERANCE: ±0.05

NO.	DESCRIPTION	MATERIAL	REMARKS	QTY
8	WATERPROOF RING	SILICONE	WHITE	1
7	GLUE	EPOXY	COLOR BLACK	1
6	BACK COVER	HIGH TEMPERATURE	COLOR BLACK	1
5	HOUSING	HIGH TEMPERATURE	COLOR BLACK	1
4	TERMINAL 4#	STAINLESS STEEL	NICKEL PLATING OVERALL	1
3	TERMINAL 3#	COPPER ALLOY	NICKEL UNDERPLATING OVERALL, Au PLATING ON THE SOLDER AREA	1
2	TERMINAL 2#	COPPER ALLOY	NICKEL UNDERPLATING OVERALL, Au PLATING ON THE WHOLE	1
1	CENTER PIN	COPPER ALLOY	NICKEL UNDERPLATING OVERALL, Au PLATING ON THE SOLDER AREA	1

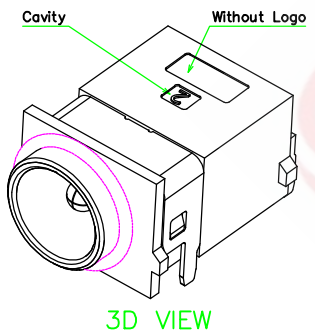

3D VIEW

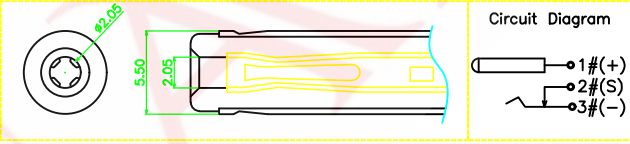

Circuit Diagram

DESIGN	WANGGUIFA	2018.06.12	≥2~5<	±0.25
CHECKED	ZHENGJILAN	2018.06.12	≥0~2<	±0.15
APPROVED	LILIANJIANG	2018.06.14	≥5	±0.35

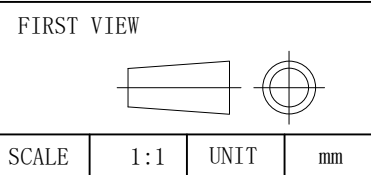

SAMZO COMPONENTS
Electronic switch and connector manufacturer

The copyright belongs to samzo parts [China] Co., Ltd. please use the material after samzo parts agree to authorize. The final right of interpretation belongs to samzo parts.
WWW.KKK-JP.COM

TITLE: :	
DC JACK WC DIP 5PIN	
DWG NO: 9FW5152-P0705	
PART NO: 9FW5152100705	
MODEL NO: 9FW5152ATFA	
NAME:	DC JACK