

ROHS

REV	ECN NO	DESCRIPTION	DESIGN	APPROVAL	DATE
A1	NEW	Replace frame			2018.06.12

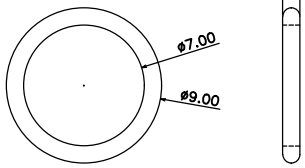

- NOTES**
- CURRENT RATING: 24V & 5A MAX.
 - CONTACT RESISTANCE: 50mΩ MAX.
 - INSULATION RESISTANCE: 100MΩ MIN.
 - DIELECTRIC WITHSTANDING: 500V AC MIN.
 - DURABILITY: 5000 CYCLES MIN.
 - CONNECTOR MATING FORCES: 3N MIN.
 - CONNECTOR UNMATING FORCES: 35N MAX.
 - OPERATING TEMPERATURE: -25°C TO +85°C.
 - WATER PROOFNESS: THIS PRODUCT IS BASED ON IPX7.

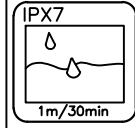
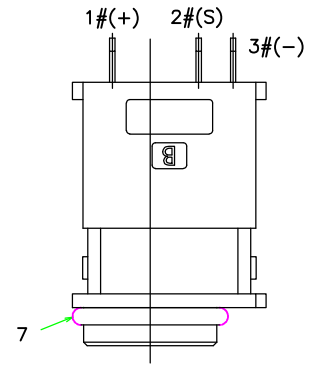
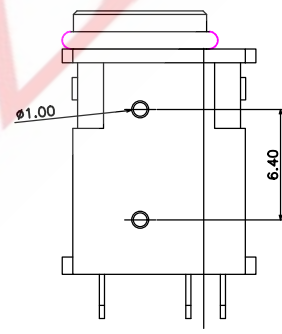
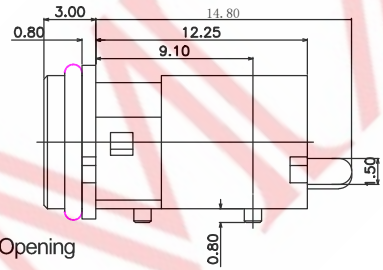
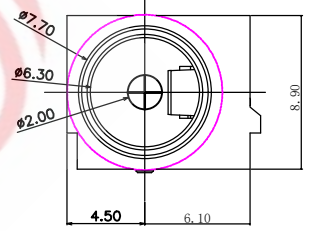
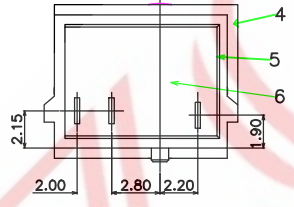
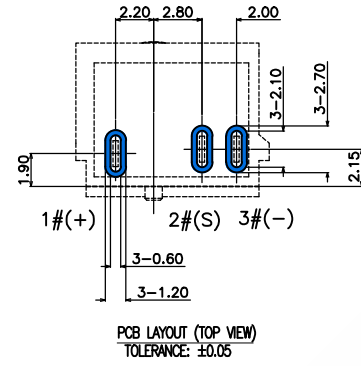

9FL3152ATFB

- MODEL DEFINITION**
- Mould Number:02
 - Needle diameter:2.0
 - Fixing Method:Fixing Column
 - Interface Method:Convention Extended Opening
 - Overall Length:15.25mm
 - Pin Position:3PIN
 - Mounting Method:DIP
 - Product Series: DC Jack IPX7

Not to install the waterproof ring shipment

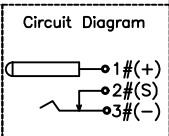
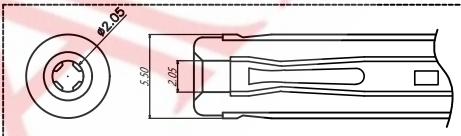

NO.	DESCRIPTION	MATERIAL	REMARKS	QTY
	WATERPROOF RING	SILICONE	WHITE	1
	GLUE	EPOXY	COLOR BLACK	1
	BACK COVER	HIGH TEMPERATURE	COLOR BLACK	1
4	HOUSING	HIGH TEMPERATURE	COLOR BLACK	1
3	TERMINAL 3#	COPPER ALLOY	NICKEL UNDERPLATING OVERALL, Au PLATING ON THE SOLDER AREA	1
2	TERMINAL 2#	COPPER ALLOY	NICKEL UNDERPLATING OVERALL, Au PLATING ON THE WHOLE	1
1	CENTER PIN 1#	COPPER ALLOY	NICKEL UNDERPLATING OVERALL, Au PLATING ON THE SOLDER AREA	1

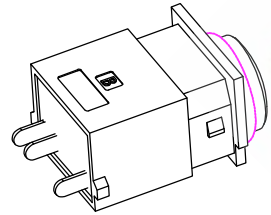

3D VIEW

DESIGN	WANGUIFA	2018.06.12	$\geq 0 \sim 2 <$	± 0.15
CHECKED	ZHENGUILAN	2018.06.12	$\geq 2 \sim 5 <$	± 0.25
APPROVED	LILIANJIANG	2018.06.14	$\geq 0 \sim 2 <$	± 0.15
			≥ 5	± 0.35

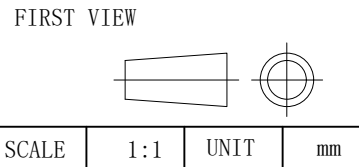

The copyright belongs to samzo parts [China] Co., Ltd. please use the material after samzo parts agree to authorize. The final right of interpretation belongs to samzo parts. WWW.KKK-JP.COM

TITLE: DC JACK LC DIP 3PIN	
DWG NO: 9FL3152-P0807	
PART NO: 9FL3152100807	
MODEL NO: 9FL3152ATFB	
NAME:	DC JACK

SAMZO COMPONENTS
Electronic switch and connector manufacturer