

恒拓电子
HENG TUO ELECTRONICS



HT series

**Photo Coupler
Product Specification**

HT-357X

■ Package

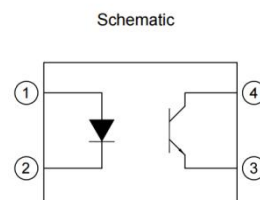
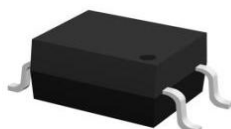

Pin Configuration
1 Anode
2 Cathode
3 Emitter
4 Collector

■ Description

The HT-357X is a photoelectric coupler composed of light-emitting diode and phototransistor. It is packaged in a 4-pin package and in wide-lead spacing and SMD option.

■ Features

- Current transfer ratio(CTR : MIN. 50% at $I_F = 5\text{mA}$, $V_{CE} = 5\text{V}$)
- High input-output isolation voltage($V_{iso} = 3,750\text{Vrms}$)
- Operating Temperature: $-55^{\circ}\text{C} \sim 110^{\circ}\text{C}$
- Safety approval
(UL 1577, VDE DIN EN60747-5-5 (VDE 0884-5) , CQC11-471543-2022)
- RoHS
- MSL1

■ Applications

- Programmable controllers
- Switching power supply, intelligent meter
- Home appliances: such as air conditioners, fans, water heaters, etc

■ Product Nomenclature

The product name is designated as below:

HT -357 X -X X- X X X- XX

① ② ③ ④ ⑤ ⑥ ⑦

Designation:

HT =Hengtuo Technology Co.,LTD.

357= Product Series

① = Lead form option(NONE)₍₁₎

② = CTR Rank(A,B,C,D,E)₍₂₎

③ = Tape and Reel option(TP, TP1)₍₃₎

④ = Lead frame Material(F,NONE)₍₄₎

⑤ = VDE order option(fixed code "V")

⑥ = Halogen free option(fixed code"G")

⑦ = Customer code

Notes

1. Lead form option:

Symbol	Description
NONE	SOP4

2. CTR Rank:

Symbol	Description
A,B,C,D,E...	CTR Rank
NONE	No Rank

3. Tape and Reel option:

Symbol	Description
TP&TP1	Tape and Reel Type

4. Lead frame Material

Symbol	Description
NONE	Copper

■ Marking Information

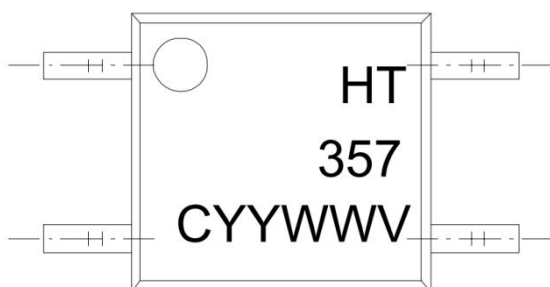
Designation:

HT denotes Hengtuo
 357 denotes Device
 C denotes CTR Rank
 YY denotes year code
 WW denotes week code
 V denotes VDE

■ Maximum Ratings

	Parameter	Symbol	Values	Unit
Input	Forward Current	I_F	50	mA
	Reverse Voltage	V_R	6	V
	Power Dissipation		70	mW
	Derating factor (above $T_a = 90^\circ\text{C}$)	P_D	2.9	mW/ $^\circ\text{C}$
Output	Collector - Emitter Voltage	V_{CEO}	80	V
	Emitter - Collector Voltage	V_{ECO}	7	V
	Collector Current	I_C	50	mA
	Collector Power Dissipation		150	mW
	Derating factor (above $T_a = 70^\circ\text{C}$)	P_C	3.7	mW/ $^\circ\text{C}$
Operating temperature range		T_{op}	-55 ~ 110	$^\circ\text{C}$
Storage temperature range		T_{stg}	-55 ~ 125	$^\circ\text{C}$
Total Power consumption		$P(W)$	200	mW
Isolation Voltage ⁽¹⁾		V_{ISO}	3750	V _{rms}
Soldering Temperature ⁽²⁾		T_{SOL}	260	$^\circ\text{C}$

Notes:

(1). AC for 1 minute, R.H.= 40 ~ 60% R.H. In this test, pins 1, 2 are shorted together, and pins 3, 4 are shorted together.

(2).For 10 seconds

■ Electronic Optical Characteristics

(TA = 25°C)

	Parameter	Symbol	Min.	Typ.	Max.	Unit	Conditon
Input	Forward Voltage	V_F	-	1.2	1.4	V	$I_F=20\text{mA}$
	Reverse Current	I_R	-	-	10	μA	$V_R=4\text{V}$
	Terminal Capacitance	C_t	-	30	250	pF	$V=0, f=1\text{KHz}$
Output	Collector Dark Current	I_{CEO}	-	-	100	nA	$V_{CE}=20\text{V}, I_F=0$
	Collector-Emitter Breakdown Voltage	BV_{CEO}	80			V	$I_C=0.1\text{mA}, I_F=0$
	Emitter-Collector Breakdown Voltage	BV_{ECO}	7			V	$I_E=10\mu\text{A}, I_F=0$
Collector-Emitter Saturation Voltage		$V_{CE(sat)}$		0.1	0.2	V	$I_F=20\text{mA}, I_C=1\text{mA}$
Isolation Resistance		R_{iso}	5×10^{10}	1×10^{11}	-	Ω	DC500V, 40 ~ 60% R.H.
Floating Capacitance		C_f		0.6	1	pF	$V=0, f=1\text{MHz}$
Cut-off Frequency		f_c		80		kHz	$V_{CE}=5\text{V}, I_C=2\text{mA}, R_L=100\Omega, -3\text{dB}$
Response Time (Rise)		t_r		4	18	μs	$V_{CE}=2\text{V}, I_C=2\text{mA}$
Response Time (Fall)		t_f		3	18	μs	$R_L=100\Omega,$

■ Rank Table Of Current Transfer Ratio

(CTR= $I_C/I_F \times 100\%$)

Rank Code	Symbol	Min	Max	Conditon
NONE	CTR	50	600	$I_F=5\text{mA}, V_{CE}=5\text{V}, T_a=25^\circ\text{C}$
A		80	160	
B		130	260	
C		200	400	
D		300	600	

■ Characteristics Curves

Fig.1 Relative Current Transfer Ratio vs. Forward Current

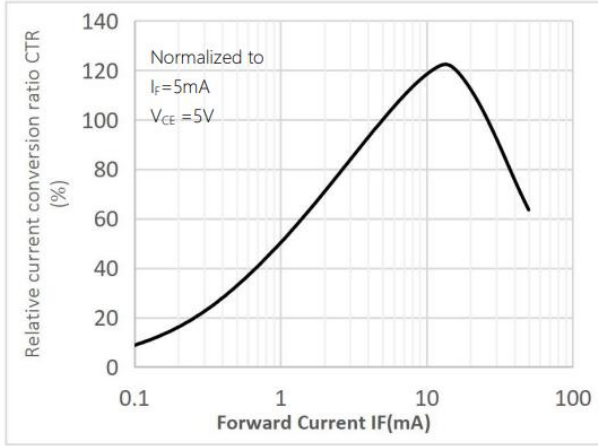

Fig.2 Forward Current vs. Forward Voltage

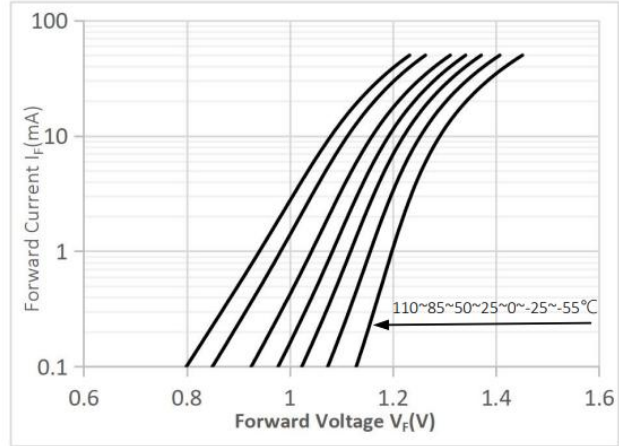

Fig.3 Collector Current vs. Collector-emitter Voltage

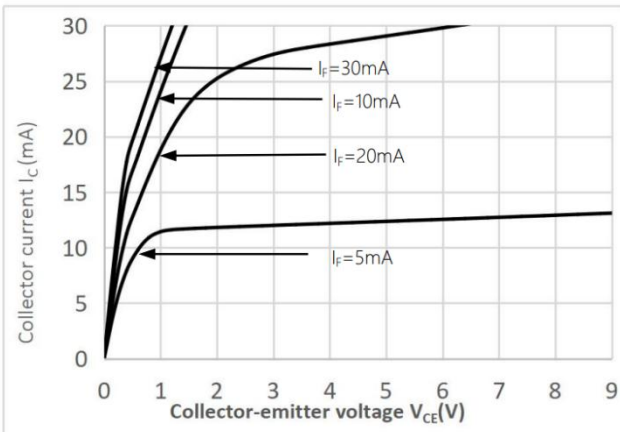

Fig.4 Relative Current Transfer Ratio vs. Ambient Temperature

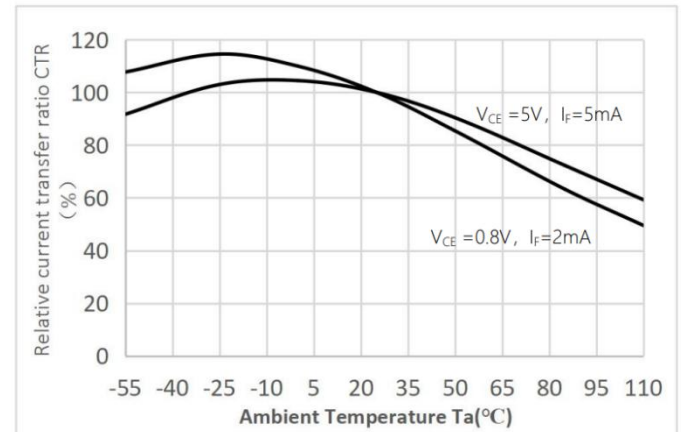

Fig.5 Collector-emitter Saturation Voltage vs. Ambient Temperature

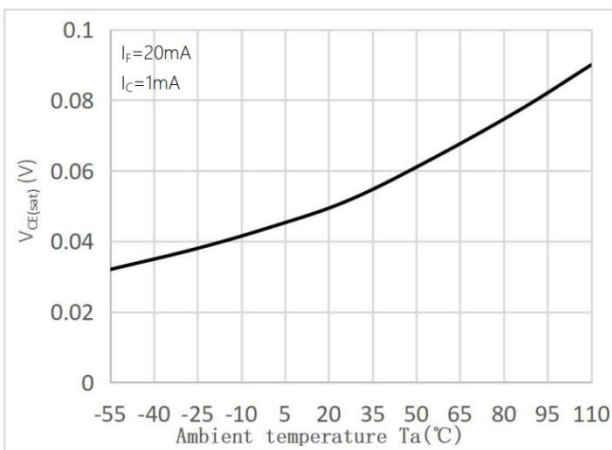

Fig.6 Collector Dark Current vs Ambient Temperature

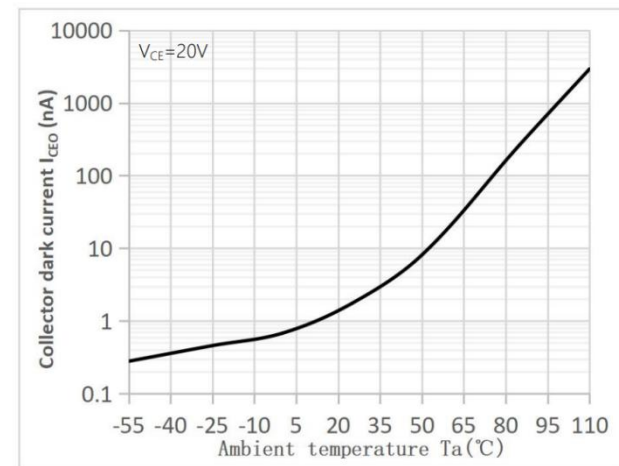

Fig.7 Response Time vs. Load Resistance

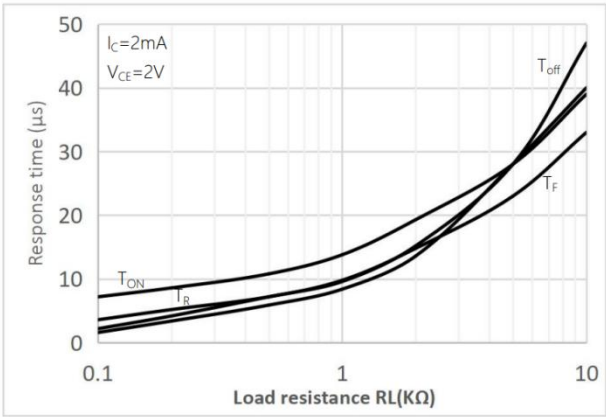

Fig.8 Frequency Response

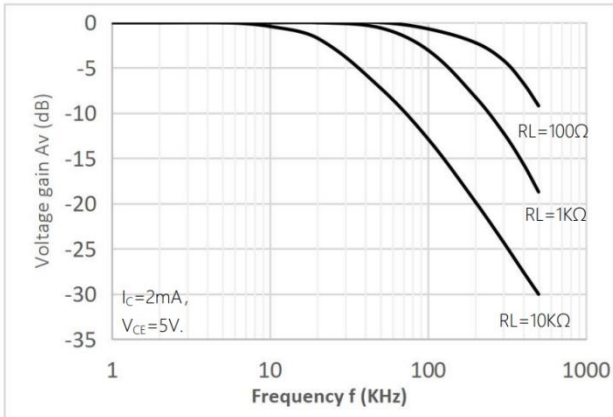

Fig.9 Collector-emitter Saturation Voltage vs Forward Current

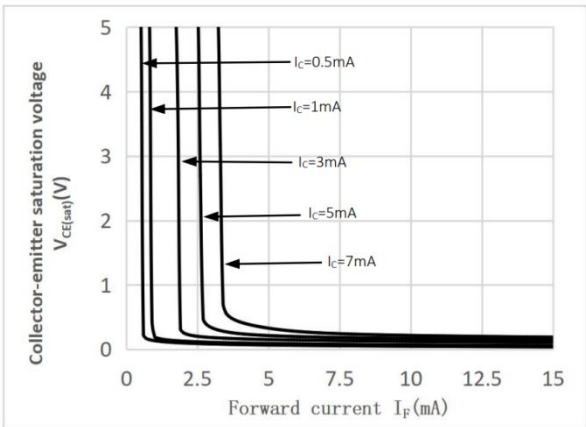
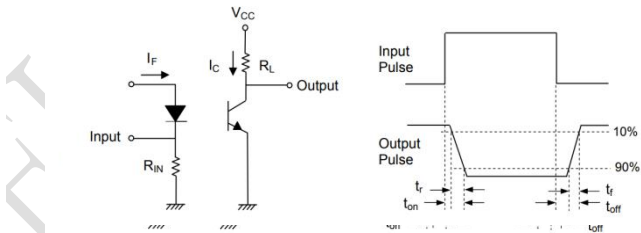
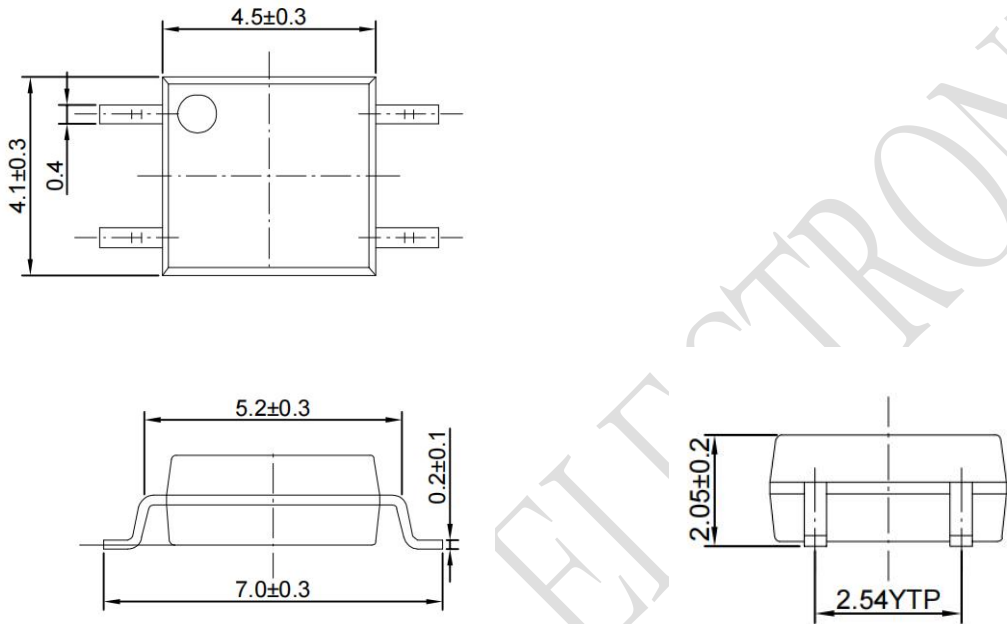

Fig.10 Switching Time Test Circuit & Waveforms



■ Outline Dimension



Unit: mm
Tolerance: ± 0.1 mm

■ Recommended solder pad Design

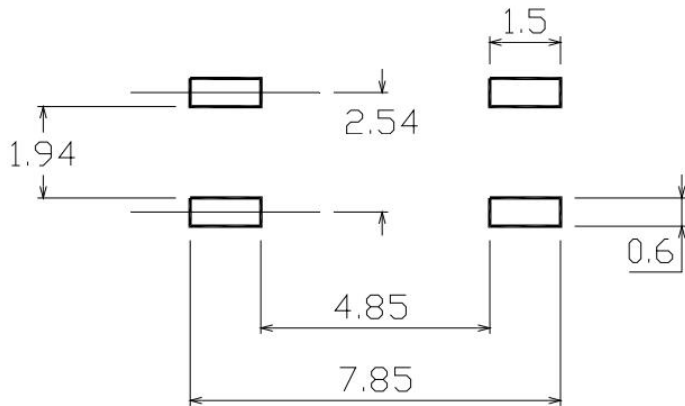

Unit: mm

■ Temperature Profile Of Soldering

1. IR Reflow soldering (JEDEC-STD-020 compliant)

Profile item	Condition
Preheat	150°C
-Temperature Min (TSmin)	200°C
-Temperature Max (TSmax)	90 ± 30 sec
-Time (min to max) (ts)	
Soldering zone	217°C
-Temperature (TL)	60 sec
-Time (tL)	
Peak Temperature (TP)	260°C
Ramp-up rate	3°C / sec max
Ramp-down rate	3~6°C/ sec

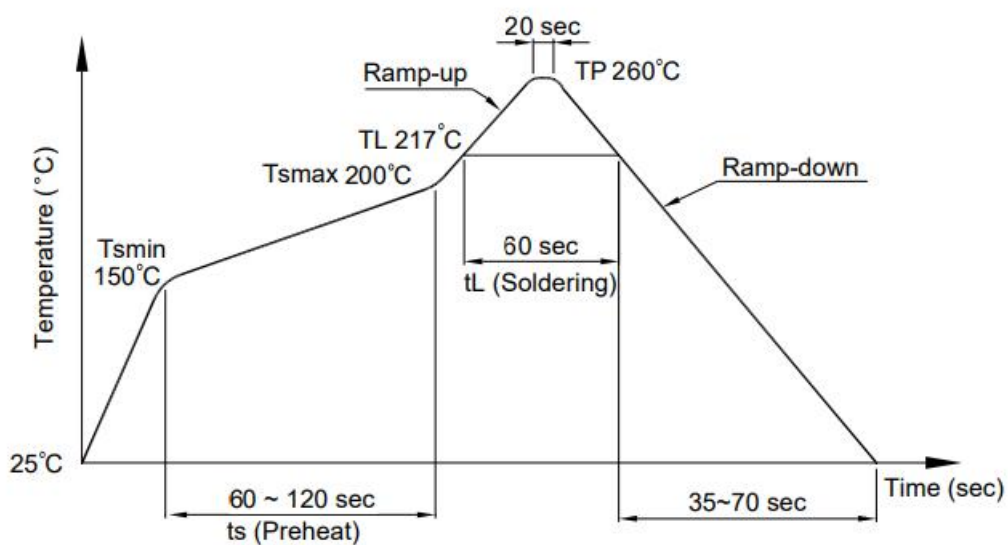

Notes:

One time soldering reflow is recommended within the condition of temperature and time profile shown below. Do not solder more than three times.

2. Wave soldering (JEDEC22A111 compliant)

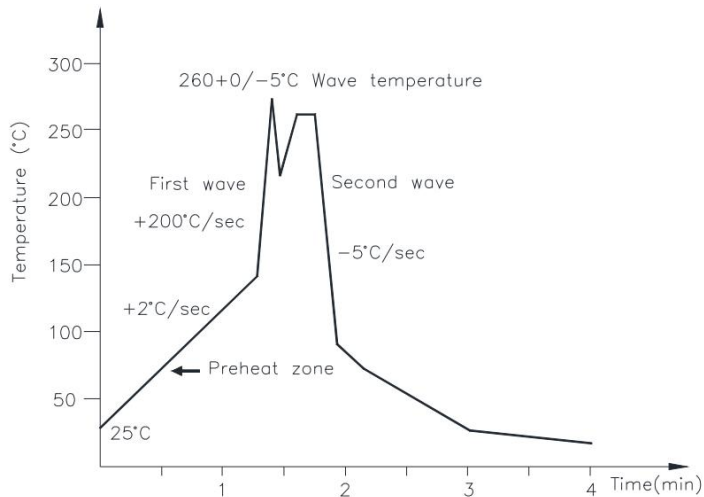

3. Hand soldering by soldering iron

Allow single lead soldering in every single process. One time soldering is recommended.

Temperature: 380±5°C

Time: 3 sec max.

■ Packing

Tape and Reel

Option TP:

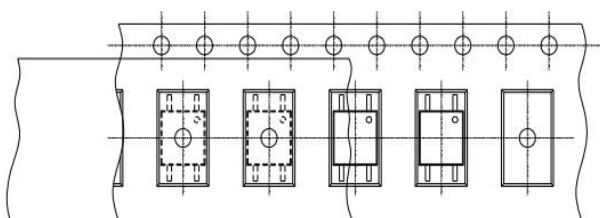

Option TP1:

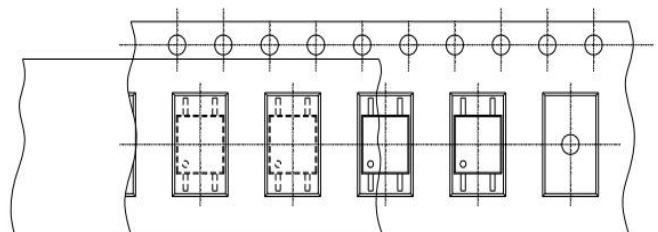

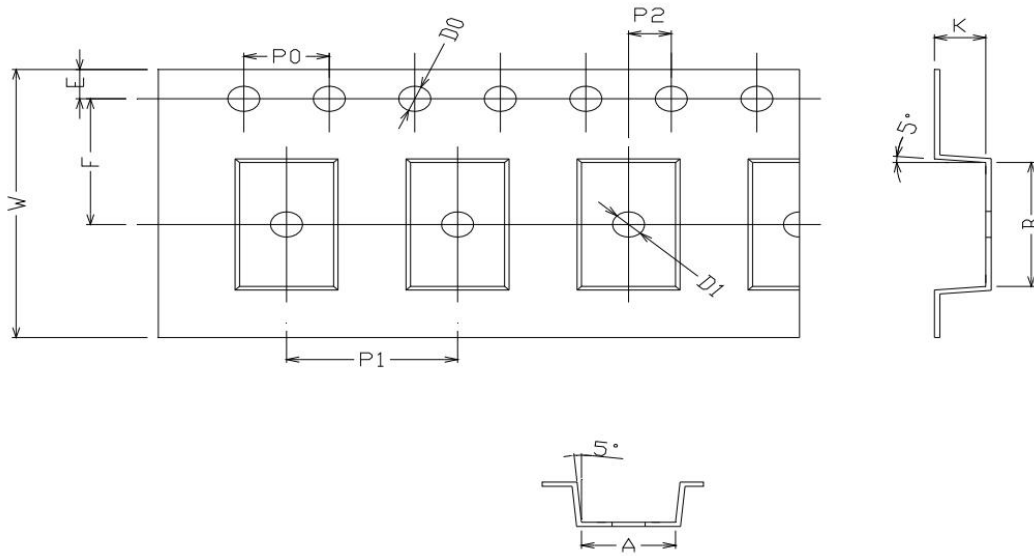

Deminsion/mm	W	E	F	P0	P1	P2
Packagetype:S	16 ± 0.2	1.75 ± 0.1	7.5 ± 0.1	4 ± 0.1	8 ± 0.1	2 ± 0.1

Deminsion/mm	A	B	D0	D1	K
Packagetype:S	4.4 ± 0.1	7.5 ± 0.1	1.5 ± 0.1	1.5 ± 0.1	2.4 ± 0.1

Packagetype:S	Reel	Inner carton	Outer carton
QTY/PCS	3K/reel	9K(3 reels)	90K

■ Attention:

- Hengtuo is continually improving the quality, reliability, function or design and Hengtuo reserves the right to make changes without further notices.
- The products shown in this publication are designed for the general use in electronic applications such as office automation equipment, communications devices, audio/visual equipment, electrical application and instrumentation.
- For equipment/devices where high reliability or safety is required, such as space applications, nuclear power control equipment, medical equipment, etc, please contact our sales representatives.
- When requiring a device for any "specific" application, please contact our sales in advice.
- If there are any questions about the contents of this publication, please contact us at your convenience.