

FAST SWITCHING DIODES

Features

- ◆ Fast switching speed
- ◆ Surface mount package ideally suited
- ◆ for automatic insertion
- ◆ For general purpose switching applications
- ◆ High conductance

SOD-323



Mechanical Data

Case: JEDEC SOD-323 molded plastic body

Terminals: Plated leads solderable per MIL-STD-750, Method 2026

Polarity: Polarity symbols marked on case

Weight : 0.0007 ounce, 0.02 grams

Marking: T4

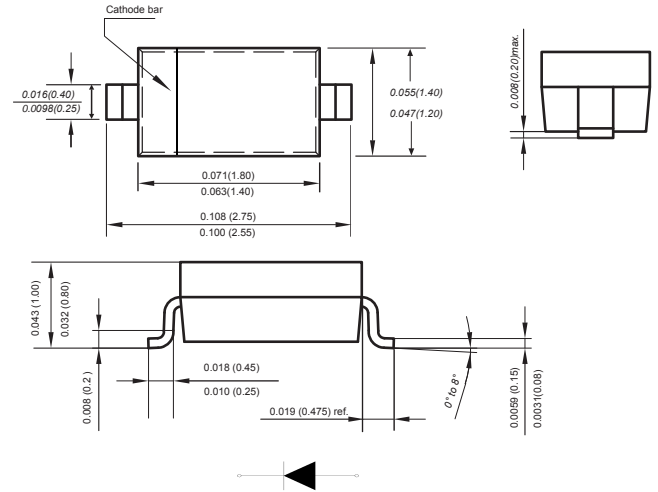

Dimensions in inches and (millimeters)

Absolute Maximum Ratings at 25 °C

PARAMETER	SYMBOLS	1N4148WS-E	UNITS
Maximum repetitive peak reverse voltage	V_{RRM}	100	V
Maximum RMS voltage	V_{RMS}	75	
Reverse Breakdown voltage at $I_R=1 \mu A$	$V_{(BR)R}$	75	
Forward continuous current	I_{FM}	300	mA
Average rectified output current	I_O	150	mA
Peak forward current	I_{FSM}	0.5	A
at 1s		1	
at 1ms		4.0	
Power dissipation	P_d	400	mW
Thermal resistance junction to ambient	$R_{\theta JA}$	250	°C/W
Junction temperature	T_j	-55 to +150	°C
Storage temperature	T_{STG}	-55 to +150	°C

Characteristics at $T_a=25 \text{ }^\circ\text{C}$

PARAMETER	SYMBOLS	Min.	Typ.	Max.	Unit	Conditions
Forward voltage	V_{F1}			0.715	V	$I_F=1.0\text{mA}$
	V_{F2}			0.855	V	$I_F=10\text{mA}$
	V_{F3}			1.0	V	$I_F=50\text{mA}$
	V_{F4}			1.25	V	$I_F=150\text{mA}$
Reverse current	I_{R1}			0.025	μA	at $V_R=20\text{V}$ $T_j=25^\circ\text{C}$
	I_{R2}			1	μA	at $V_R=75\text{V}$ $T_j=25^\circ\text{C}$
	I_{R3}			30	μA	at $V_R=25\text{V}$ $T_j=150^\circ\text{C}$
	I_{R4}			50	μA	at $V_R=75\text{V}$ $T_j=150^\circ\text{C}$
Capacitance between terminals	C_T			2	pF	$V_R=0\text{V}, f=1.0\text{MHz}$
Reverse recovery time	t_{rr}			4	ns	$I_F=I_R=10\text{mA}$ $I_{rr}=0.1I_R, R_L=100 \Omega$

Typical Characteristics

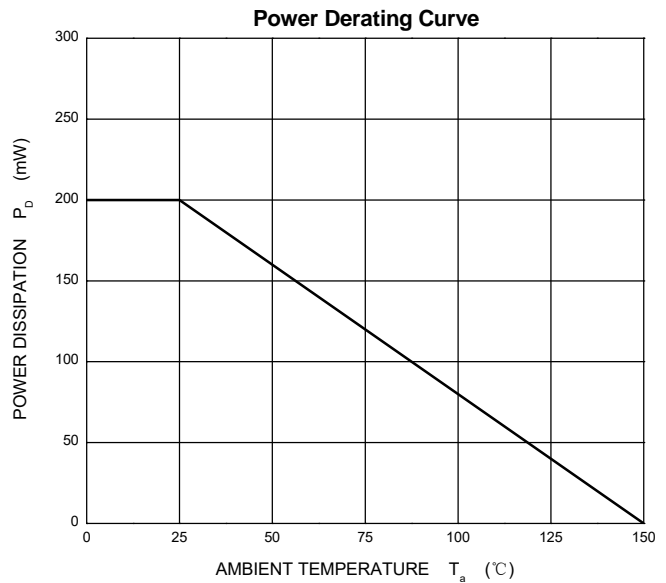
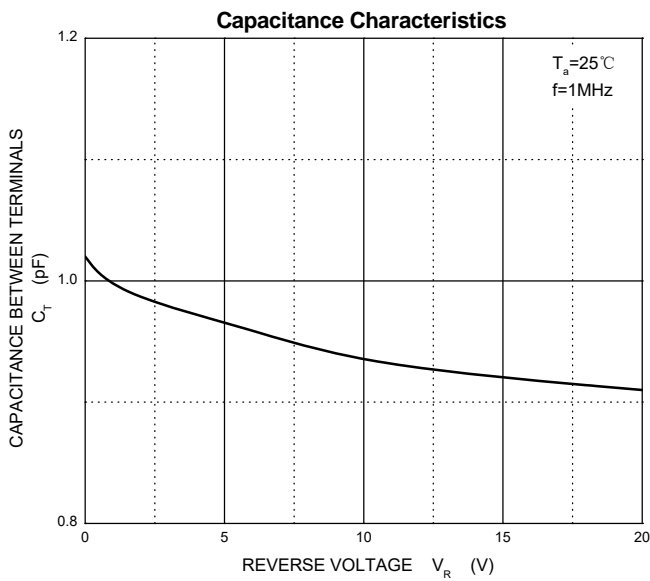
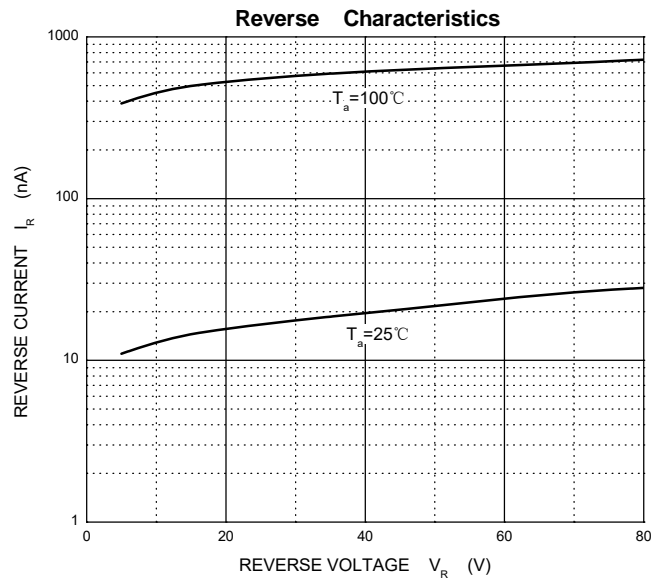
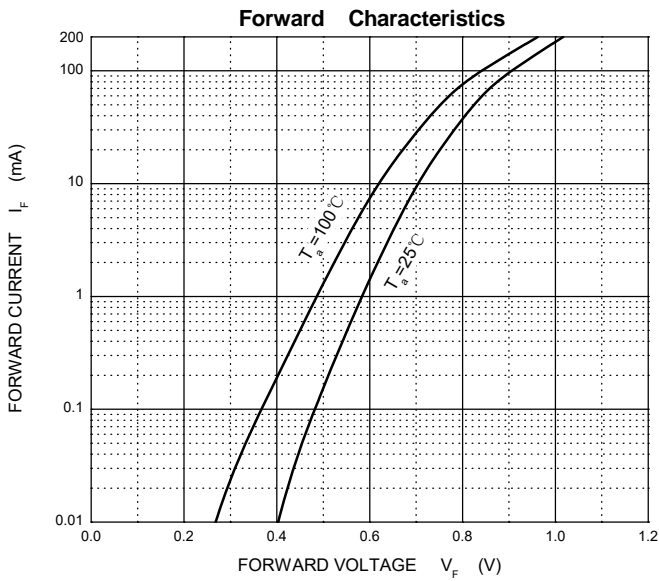

The curve above is for reference only.

Packing information

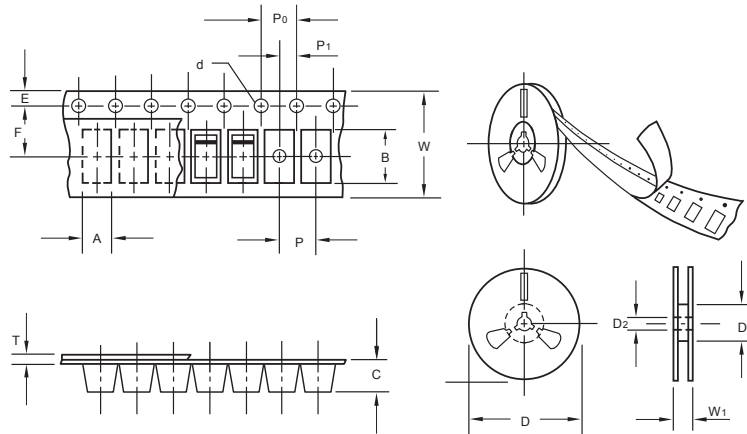

unit:mm

Item	Symbol	Tolerance	SOD-323
Carrier width	A	0.1	2.1
Carrier length	B	0.1	4.0
Carrier depth	C	0.1	1.60
Sprocket hole	d	0.05	1.55
7" Reel outside diameter	D	2.0	178.00
7" Reel inner diameter	D ₁	min	50.0
Feed hole diameter	D ₂	0.5	13.00
Sprocket hole position	E	0.1	1.75
Punch hole position	F	0.1	3.50
Punch hole pitch	P	0.1	4.00
Sprocket hole pitch	P ₀	0.1	4.00
Embossment center	P ₁	0.1	2.00
Overall tape thickness	T	0.1	0.25
Tape width	W	0.3	8.15
Reel width	W ₁	1.0	10.5

Note: Devices are packed in accordance with EIA standard RS-481-A and specifications listed above.

Reel packing

PACKAGE	REEL SIZE	REEL (pcs)	COMPONENT SPACING (m/m)	BOX (pcs)	INNER BOX (m/m)	REEL DIA, (m/m)	CARTON SIZE (m/m)	CARTON (pcs)	APPROX. GROSS WEIGHT (kg)
SOD-323	7"	3,000	4.0	45,000	210*208*203	178	430*430*235	180,000	

Suggested Pad Layout

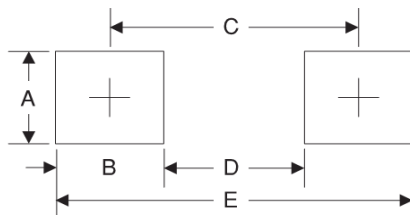

Symbol	Unit (mm)	Unit (inch)
A	0.7	0.028
B	0.7	0.028
C	2.15	0.085
D	1.45	0.057
E	2.85	0.112