

## FAST SWITCHING DIODES

### Features

- ◆ Fast switching speed
- ◆ Surface mount package ideally suited
- ◆ for automatic insertion
- ◆ For general purpose switching applications High
- ◆ conductance

**SOD-123**

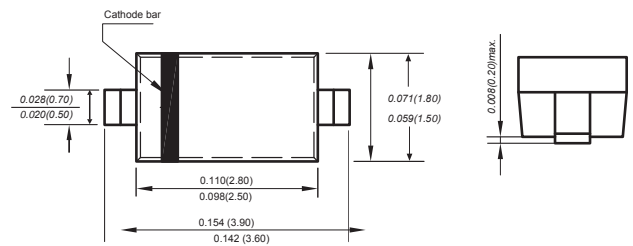

### Mechanical Data

Case: JEDEC SOD-123 molded plastic body  
 Terminals: Plated leads solderable per MIL-STD-750, Method 2026  
 Polarity: Polarity symbols marked on case  
 Weight : 0.00056ounce, 0.016grams  
 Marking: T4

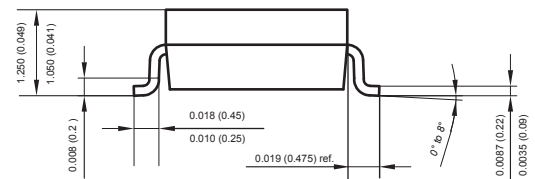

Dimensions in inches and (millimeters)

### Absolute Maximum Ratings at 25 °C

Parameter	Symbols	1N4148W-E	Units
Maximum Repetitive Peak Reverse Voltage	$V_{RRM}$	100	V
Maximum RMS voltage	$V_{RMS}$	75	V
Average rectified output current	$I_{F(AV)}$	150	mA
Non-reptitive Peak Forward Surge Current	$I_{FSM}$	0.5 1 4	A
		at 1s	
		at 1ms	
		at 1us	
Total Power Dissipation	$P_{tot}$	400	mW
Typical Thermal Resistance <sup>(1)</sup>	$R_{\theta JA}$	280	°C/W
Operating and Storage Temperature Range	$T_j, T_{stg}$	-55 ~ +150	°C

( 1 ) P.C.B. mounted with 5 X 5 mm copper pad areas.

### Characteristics at Ta= 25 °C

Parameter	Symbols	1N4148W-E	Units
Reverse Breakdown Voltage at $I_R=1\mu A$	$V_{(BR)R}$	75	V
Maximum Forward Voltage	$V_F$	0.715 0.855 1.00 1.25	V
		at 1m A	
		at 10 m A	
		at 50 m A	
		at 150mA	
Peak Reverse Current	$I_R$	0.025 1 30 50	uA
		at $V_R=20V T_j=25^\circ C$	
		at $V_R=75V T_j=25^\circ C$	
		at $V_R=25V T_j=150^\circ C$	
		at $V_R=75V T_j=150^\circ C$	
Typical Junction Capacitance	$C_j$	2	pF
Maximum Reverse Recovery Time	$t_{rr}$	4	ns

## Typical Characteristics

### Forward Characteristics

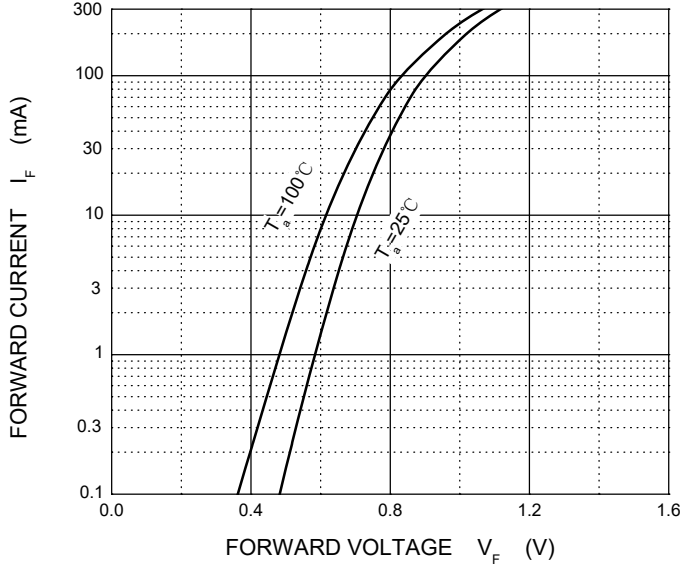

### Reverse Characteristics

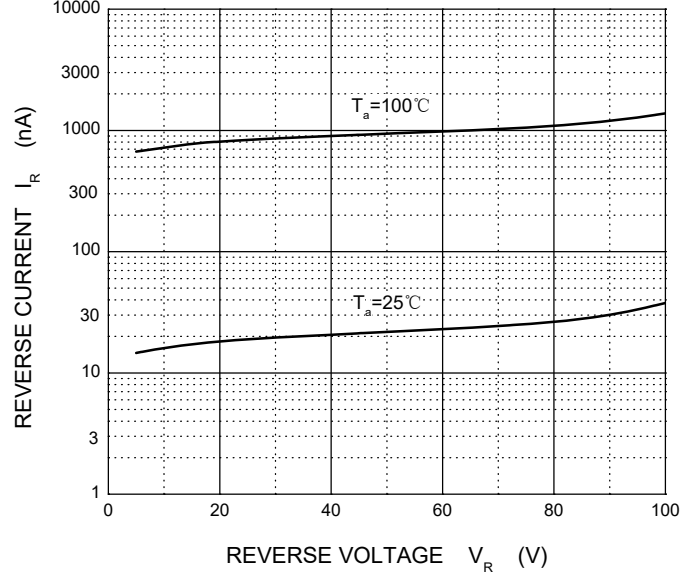

### Capacitance Characteristics

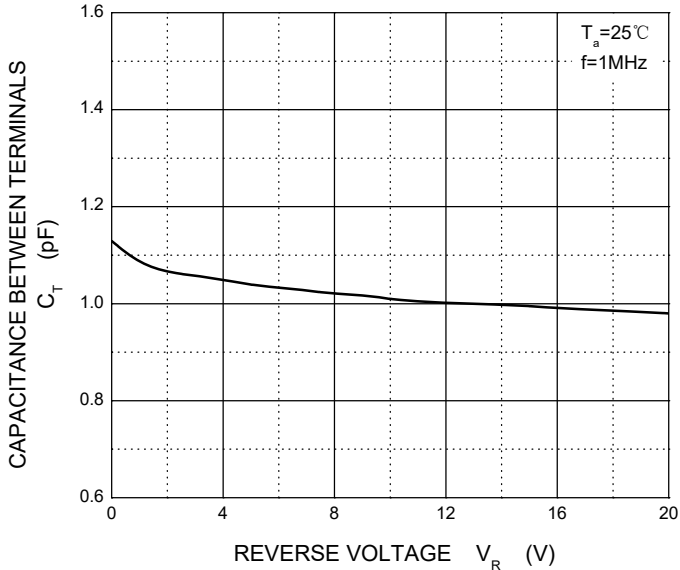

### Power Derating Curve

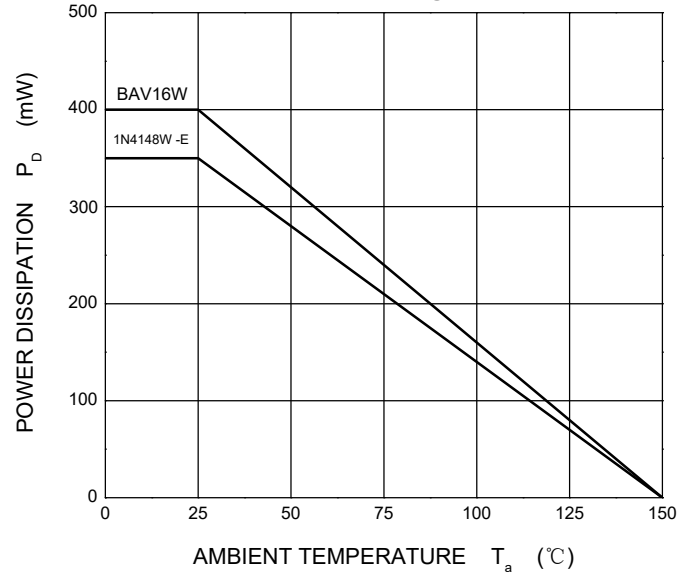

The curve above is for reference only.

## Packing information

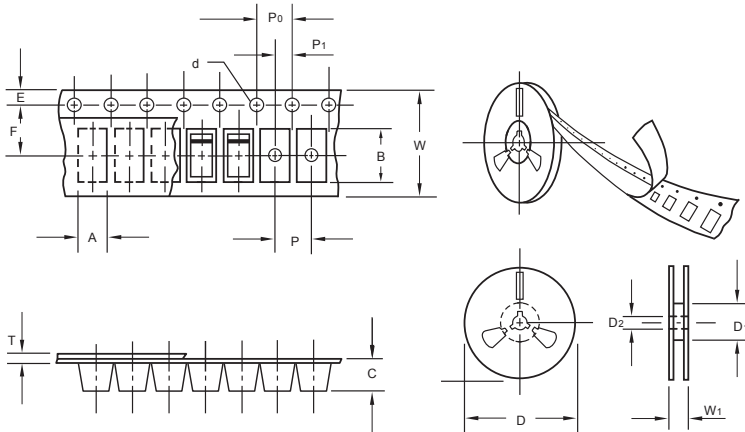

unit:mm

Item	Symbol	Tolerance	SOD-123
Carrier width	A	0.1	2.1
Carrier length	B	0.1	4.0
Carrier depth	C	0.1	1.60
Sprocket hole	d	0.05	1.55
7" Reel outside diameter	D	2.0	178.00
7" Reel inner diameter	D <sub>1</sub>	min	50.0
Feed hole diameter	D <sub>2</sub>	0.5	13.00
Sprocket hole position	E	0.1	1.75
Punch hole position	F	0.1	3.50
Punch hole pitch	P	0.1	4.00
Sprocket hole pitch	P <sub>0</sub>	0.1	4.00
Embossment center	P <sub>1</sub>	0.1	2.00
Overall tape thickness	T	0.1	0.25
Tape width	W	0.3	8.15
Reel width	W <sub>1</sub>	1.0	10.5

Note: Devices are packed in accordance with EIA standard RS-481-A and specifications listed above.

## Reel packing

PACKAGE	REEL SIZE	REEL (pcs)	COMPONENT SPACING (m/m)	BOX (pcs)	INNER BOX (m/m)	REEL DIA, (m/m)	CARTON SIZE (m/m)	CARTON (pcs)	APPROX. GROSS WEIGHT (kg)
SOD-123	7"	3,000	4.0	45,000	210*208*203	178	430*430*235	180,000	9.0

## Suggested Pad Layout

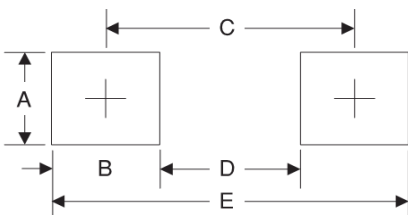

Symbol	Unit (mm)	Unit (inch)
A	1.2	0.047
B	1.2	0.047
C	3.2	0.126
D	2.0	0.079
E	4.4	0.173