

Single/Dual/Quad, Low Offset, Low Noise, RRO Operational Amplifiers

Features

- Guaranteed 2.7V and 5V specifications
- Maximum V_{OS} (LMV771): 850uA(limit)
- Voltage Noise ;
 $f = 100\text{Hz}: 12.5\text{nV}/\sqrt{\text{Hz}}$
 $f = 10\text{kHz}: 7.5\text{nV}/\sqrt{\text{Hz}}$
- Rail-to-Rail output swing;
 w/600Ω load; 100mV from rail
 w/2kΩ load; 50mV from rail
- Open loop gain w/2kΩ load: 100dB
- $V_{CM}: 0$ to $V^+ - 0.9\text{V}$
- Supply current (per amplifier): 550μA
- Gain bandwidth product: 3.5MHz
- Temperature range: -40°C to 125°C



Ordering Information

DEVICE	Package Type	MARKING	Packing	Packing Qty
LMV771M7/TR	SC70-5(SOT-353)	V771	REEL	3000pcs/reel
LMV772M/TR	SOP-8	LMV772, V772	REEL	2500pcs/reel
LMV772MM/TR	MSOP-8	V772	REEL	3000pcs/reel
LMV774M/TR	SOP-14	LMV774, V774	REEL	2500pcs/reel
LMV774MT/TR	TSSOP-14	LMV774, V774	REEL	2500pcs/reel

Note: SOT-353 equal to SC70-5 Package Type.

General Description

The LMV771/LMV772/LMV774 are Single, Dual, and Quad low noise precision operational amplifiers intended for use in a wide range of applications. Other important characteristics of the family include extended operating temperature range, -40°C to 125°C , tiny SC70-5 package for LMV771, and low input bias current.

The extended temperature range of -40°C to 125°C allows the LMV771/LMV772/LMV774 to accommodate a broad range of applications. The LMV771/ LMV772/LMV774 are guaranteed to operate over the voltage range of 2.7V to 5.0V and all have rail-to-rail output.

The LMV771/LMV772/LMV774 family is designed for precision, low noise, low voltage, and miniature systems. These amplifiers provide rail-to-rail output swing into heavy loads. The maximum input offset voltage for LMV771 is 850 μV at room temperature and the input common mode voltage range includes ground. The LMV771 is offered in the tiny SC70-5 package, LMV772 in space saving MSOP-8 and SOP-8, and the LMV774 in SOP-14 and TSSOP-14.

Applications

- Transducer amplifier
- Instrumentation amplifier
- Precision current sensing
- Data acquisition systems
- Active filters and buffers
- Sample and hold
- Portable/battery powered electronics

Connection Diagram

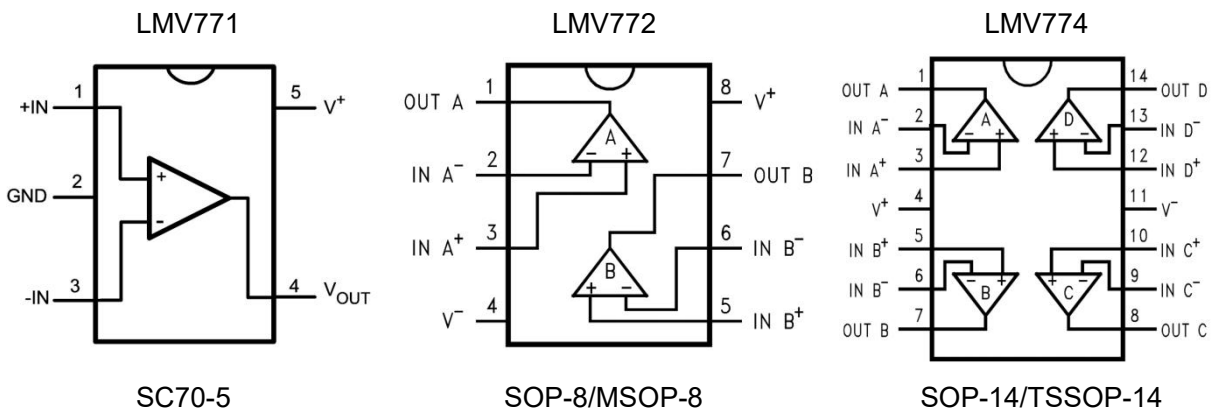

Instrumentation Amplifier

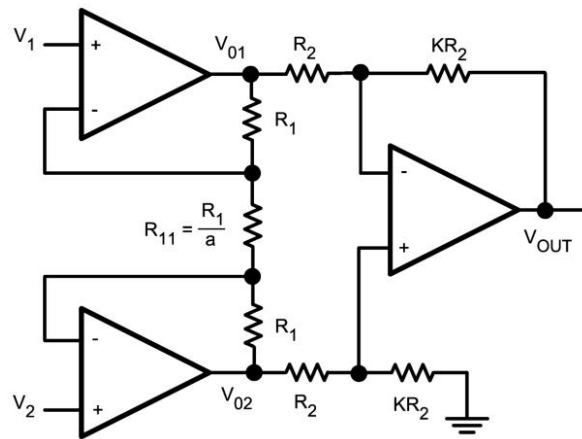

$$V_O = -K(2a + 1)(V_1 - V_2)$$

Absolute Maximum Ratings (Note 1)

Condition	Min	Max
Differential Input Voltage	± Supply Voltage	
Supply Voltage (V ⁺ -V ⁻)		5.5V
Output Short Circuit to V ⁺		(Note 3)
Output Short Circuit to V ⁻		(Note 4)
Mounting Temperature		
Infrared or Convection (20 sec)		235°C
Wave Soldering Lead Temp (10sec)		245°C
Storage Temperature Rang	-65°C	150°C
Junction Temperature (Note 5)		150°C
ESD Tolerance (Note 2)		
Machine Model		200V
Human Body Model		2000V

Operating Ratings (Note 1)

Condition	Min	Max
Supply Voltage	2.7V	5.5V
Temperature Range	-40°C	125°C
Thermal Resistance (θ _{JA})		
8-Pin MSOP		235°C/W
SC70-5 Package		440°C/W
8-Pin SOP		190°C/W
14-Pin TSSOP		155°C/W

Note 1: Absolute Maximum Ratings indicate limits beyond which damage to the device may occur. Operating Ratings indicate conditions for which the device is intended to be functional, but specific performance is not guaranteed. For guaranteed specifications and the test conditions, see the Electrical Characteristics.

Note 2: Human body model, 1.5kΩ in series with 100pF. Machine model, 0Ω in series with 20pF.

Note 3: Shorting output to V⁺ will adversely affect reliability.

Note 4: Shorting output to V⁻ will adversely affect reliability.

2.7V DC Electrical Characteristics (Note 13)

Unless otherwise specified, all limits guaranteed for $T_J = 25^\circ\text{C}$, $V^+ = 2.7\text{V}$, $V^- = 0\text{V}$, $V_{\text{CM}} = V^+/2$, $V_O = V^+/2$ and $R_L > 1\text{M}\Omega$. **Boldface** limits apply at the temperature extremes.

Symbol	Parameter	Condition	Min (Note 7)	Typ (Note 6)	Max (Note 7)	Units
V_{OS}	Input Offset Voltage	LMV771		0.3	0.85 1.0	mV
		LMV772/LMV774		0.3	1.0 1.2	
TCV_{OS}	Input Offset Voltage Average Drift			-0.45		$\mu\text{V}/^\circ\text{C}$
I_B	Input Bias Current (Note 8)			-0.1	100	pA
I_{OS}	Input Offset Current (Note 8)			0.004	100	pA
I_S	Supply Current (Per Amplifier)			550	900 910	μA
CMRR	Common Mode Rejection Ratio	$0.5 \leq V_{\text{CM}} \leq 1.2\text{V}$	74 72	80		dB
PSSR	Power Supply Rejection Ratio	$2.7\text{V} \leq V^+ \leq 5\text{V}$	82 76	90		dB
V_{CM}	Input Common-Mode Voltage Range	For CMRR $\geq 50\text{dB}$	0		1.8	V
A_V	Large Signal Voltage Gain (Note 9)	$R_L = 600\Omega$ to 1.35V , $V_O = 0.2\text{V}$ to 2.5V (Note 10)	92 80	100		dB
		$R_L = 2\text{k}\Omega$ to 1.35V , $V_O = 0.2\text{V}$ to 2.5V (Note 11)	98 86	100		
V_O	Output Swing	$R_L = 600\Omega$ to 1.35V , $V_{\text{IN}} = \pm 100\text{mV}$ (Note 10)	0.11 0.14	0.084 to 2.62	2.59 2.56	V
		$R_L = 2\text{k}\Omega$ to 1.35V , $V_{\text{IN}} = \pm 100\text{mV}$ (Note 11)	0.05 0.06	0.026 to 2.68	2.65 2.64	
I_O	Output Short Circuit Current	Sourcing, $V_O = 0\text{V}$, $V_{\text{IN}} = 100\text{mV}$	18 11	24		mA
		Sinking, $V_O = 2.7\text{V}$, $V_{\text{IN}} = -100\text{mV}$	18 11	22		

2.7V AC Electrical Characteristics (Note 13)

 Unless otherwise specified, all limits guaranteed for $T_J = 25^\circ\text{C}$, $V^+ = 5.0\text{V}$, $V^- = 0\text{V}$, $V_{\text{CM}} = V^+/2$, $V_O = V^+/2$ and $R_L > 1\text{M}\Omega$.

Boldface limits apply at the temperature extremes.

Symbol	Parameter	Conditions	Min (Note 7)	Typ (Note 6)	Max (Note 7)	Units
SR	Slew Rate	(Note 12)		1.4		V/ μs
GBW	Gain-Bandwidth Product			3.5		MHz
Φ_m	Phase Margin			79		Deg
G_m	Gain Margin			-15		dB
e_n	Input-Referred Voltage Noise (Flatband)	$f = 10\text{kHz}$		7.5		nV/ $\sqrt{\text{Hz}}$
e_n	Input-Referred Voltage Noise(1/f)	$f = 100\text{Hz}$		12.5		nV/ $\sqrt{\text{Hz}}$
i_n	Input-Referred Current Noise	$f = 1\text{kHz}$		0.001		pA/ $\sqrt{\text{Hz}}$
THD	Total Harmonic Distortion	$f = 1\text{kHz}$, $A_V = +1$ $R_L = 600\Omega$, $V_{\text{IN}} = 1\text{V}_{\text{PP}}$		0.007		%

5.0V DC Electrical Characteristics (Note 13)

 Unless otherwise specified, all limits guaranteed for $T_J = 25^\circ\text{C}$, $V^+ = 5.0\text{V}$, $V^- = 0\text{V}$, $V_{\text{CM}} = V^+/2$, $V_O = V^+/2$ and $R_L > 1\text{M}\Omega$.

Boldface limits apply at the temperature extremes.

Symbol	Parameter	Condition	Min (Note 7)	Typ (Note 6)	Max (Note 7)	Units
V_{OS}	Input Offset Voltage	LMV771		0.25	0.85 1.0	mV
		LMV772/LMV774		0.25	1.0 1.2	
TCV_{OS}	Input Offset Voltage Average Drift			-0.35		$\mu\text{V}/^\circ\text{C}$
I_B	Input Bias Current (Note 8)			-0.23	100	pA
I_{OS}	Input Offset Current (Note 8)			0.017	100	pA
I_S	Supply Current(Per Amplifier)			600	950 960	μA
CMRR	Common Mode Rejection Ratio	$0.5 \leq V_{\text{CM}} \leq 3.5\text{V}$	80 79	90		dB
PSRR	Power Supply Rejection Ratio	$2.7\text{V} \leq V^+ \leq 5\text{V}$	82 76	90		dB
V_{CM}	Input Common-Mode Voltage Range	For $\text{CMRR} \geq 50\text{dB}$	0		4.1	V
A_V	Large Signal Voltage Gain (Note 9)	$R_L = 600\Omega$ to 2.5V , $V_O = 0.2\text{V}$ to 4.8V , (Note 10)	92 89	100		dB
		$R_L = 2\text{k}\Omega$ to 2.5V , $V_O = 0.2\text{V}$ to 4.8V , (Note 11)	98 95	100		
V_O	Output Swing	$R_L = 600\Omega$ to 2.5V $V_{\text{IN}} = \pm 100\text{mV}$, (Note 10)	0.15 0.23	0.112 to 4.9	4.85 4.77	V
		$R_L = 2\text{k}\Omega$ to 2.5V $V_{\text{IN}} = \pm 100\text{mV}$, (Note 11)	0.06 0.07	0.035 to 4.97	4.94 4.93	
I_O	Output Short Circuit Current (Note 8),(Note 14)	Sourcing, $V_O = 0\text{V}$ $V_{\text{IN}} = 100\text{mV}$	35 35	75		mA
		Sinking, $V_O = 2.7\text{V}$ $V_{\text{IN}} = -100\text{mV}$	35 35	66		

5.0V AC Electrical Characteristics (Note 13)

Unless otherwise specified, all limits guaranteed for $T_J=25^\circ\text{C}$, $V^+=5.0\text{V}$, $V^-=0\text{V}$, $V_{\text{CM}}=V^+/2$, $V_O=V^+/2$ and $R_L > 1\text{M}\Omega$. **Boldface** limits apply at the temperature extremes

Symbol	Parameter	Conditions	Min (Note 7)	Typ (Note 6)	Max (Note 7)	Units
SR	Slew Rate	(Note 12)		1.4		V/ μs
GBW	Gain-Bandwidth Product			3.5		MHz
Φ_m	Phase Margin			79		Deg
G_m	Gain Margin			-15		dB
e_n	Input-Referred Voltage Noise(Flatband)	$f = 10\text{kHz}$		6.5		$\text{nV}/\sqrt{\text{Hz}}$
e_n	Input-Referred Voltage Noise(1/f)	$f = 100\text{Hz}$		12		$\text{nV}/\sqrt{\text{Hz}}$
i_n	Input-Referred Current Noise	$f = 1\text{kHz}$		0.001		$\text{pA}/\sqrt{\text{Hz}}$
THD	Total Harmonic Distortion	$f = 1\text{kHz}$, $A_V = +1$ $R_L = 600\Omega$, $V_{\text{IN}} = 1 V_{\text{PP}}$		0.007		%

Note 5: The maximum power dissipation is a function of $T_{J(\text{MAX})}$, θ_{JA} , and T_A . The maximum allowable power dissipation at any ambient temperature is $P_D = (T_{J(\text{MAX})} - T_A) / \theta_{\text{JA}}$. All numbers apply for packages soldered directly into a PC board.

Note 6: Typical Values represent the most likely parametric norm. **Note 7:** All limits are guaranteed by testing or statistical analysis. **Note 8:** Limits guaranteed by design.

Note 9: R_L is connected to mid-supply. The output voltage is set at 200mV from the rails. $V_O = \text{GND} + 0.2\text{V}$ and $V_O = V^+ - 0.2\text{V}$

Note 10: For LMV772/LMV774, temperature limits apply to -40°C to 85°C .

Note 11: For LMV772/LMV774, temperature limits apply to -40°C to 85°C . If R_L is relaxed to $10\text{k}\Omega$, then for LMV772/LMV774 temperature limits apply to -40°C to 125°C .

Note 12: Connected as voltage follower with 2VPP step input. Number specified is the slower of positive and negative slew rates.

Note 13: Electrical Table values apply only for factory testing conditions at the temperature indicated. Factory testing conditions result in very limited self-heating of the device such that $T_J = T_A$. No guarantee of parametric performance is indicated in the electrical tables under the conditions of internal self-heating where $T_J > T_A$. Absolute Maximum Rating indicated junction temperature limits beyond which the device may be permanently degraded, either mechanically or electrically.

Note 14: Continuous operation of the device with an output short circuit current larger than 35mA may cause permanent damage to the device

Typical Performance Characteristics

V_{OS} vs. V_{CM} Over Temperature

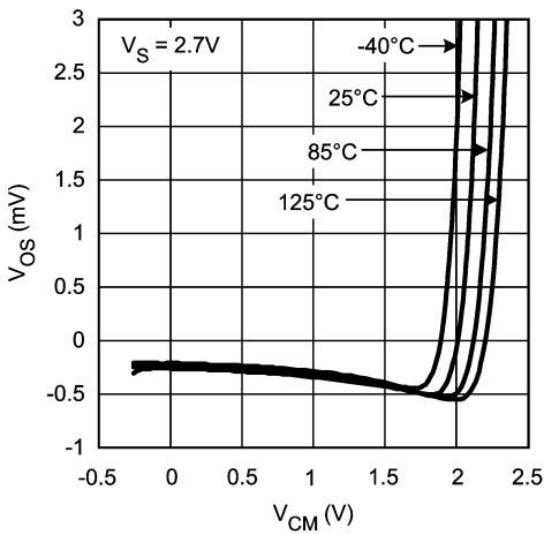

V_{OS} vs. V_{CM} Over Temperature

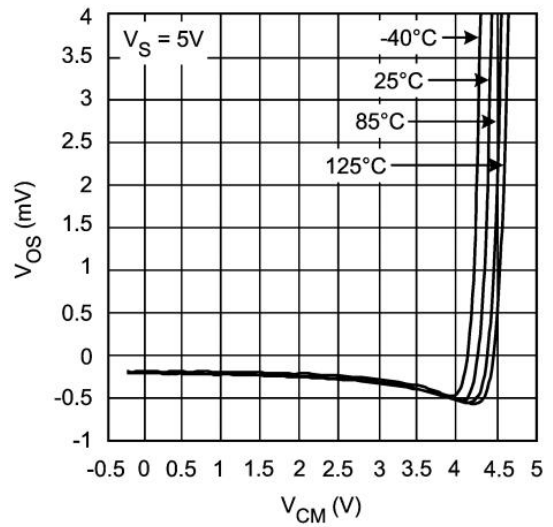

Output Swing vs. V_S

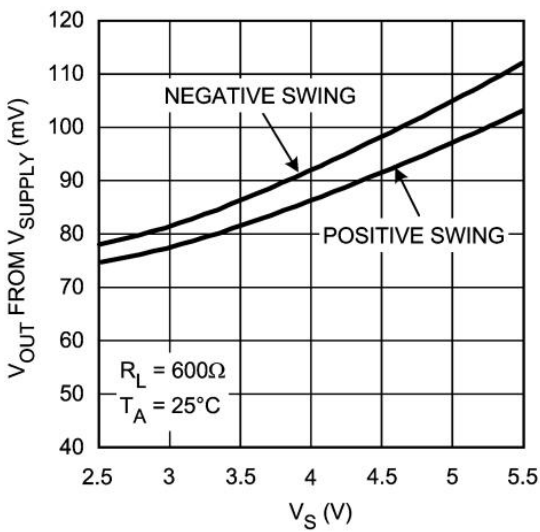

Output Swing vs. V_S

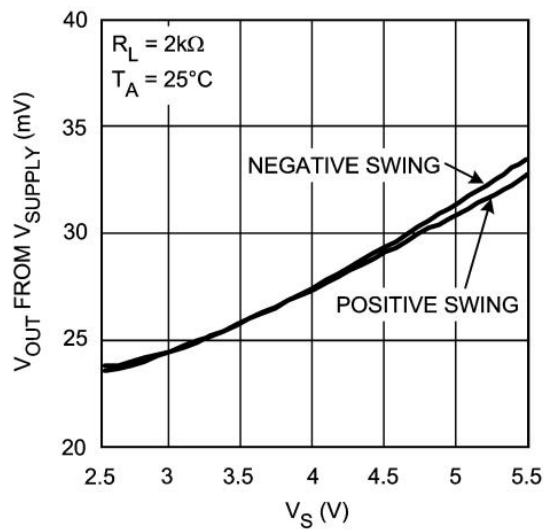

Output Swing vs. V_S

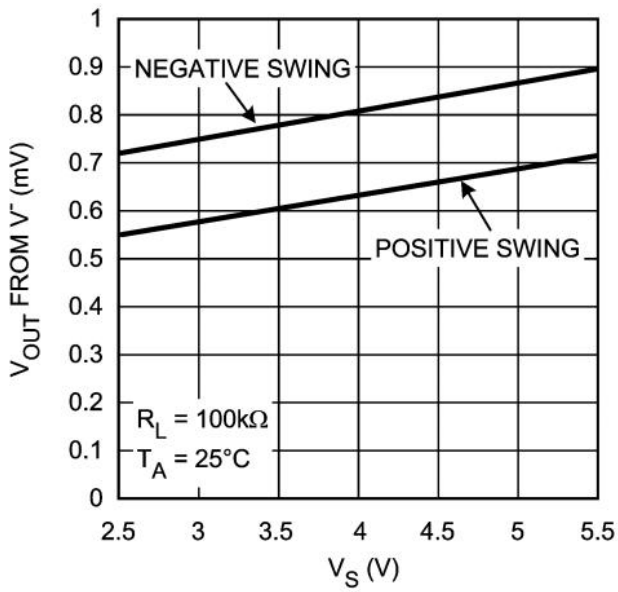

I_S vs. V_S Over Temperature

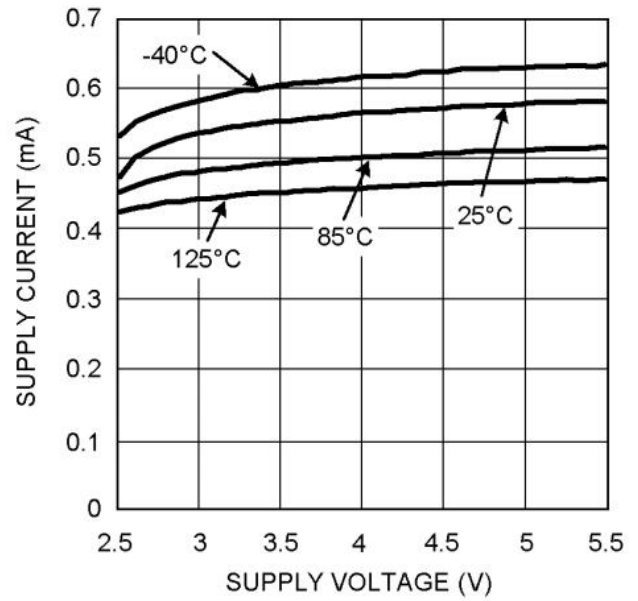

V_{IN} vs. V_{OUT}

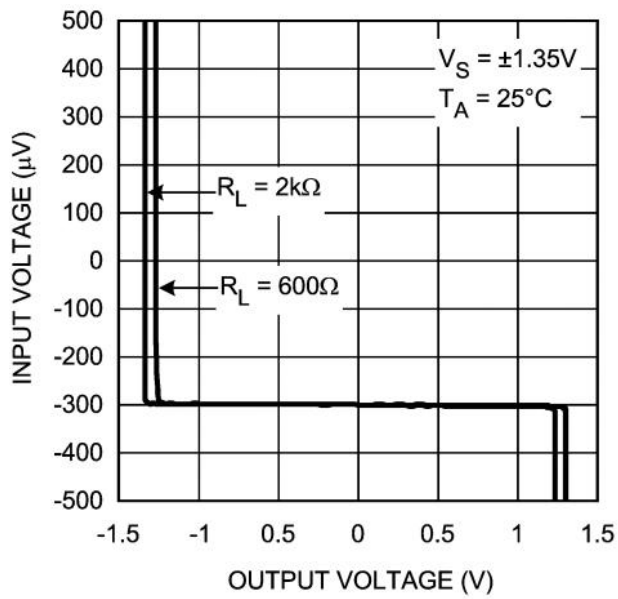

V_{IN} vs. V_{OUT}

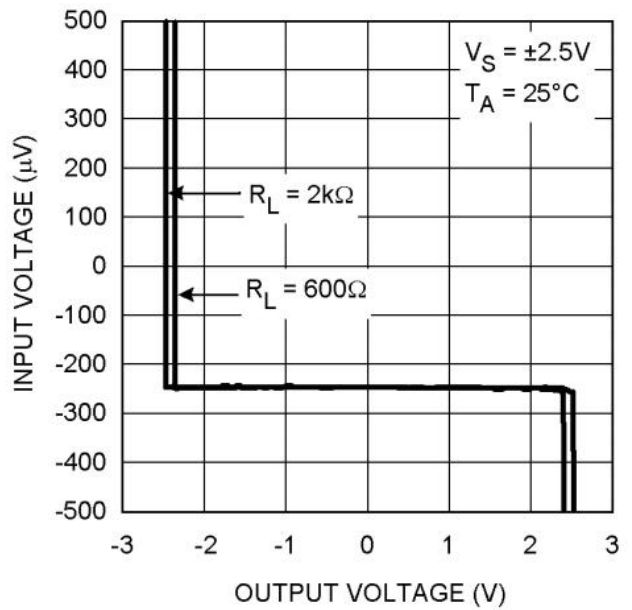

Sourcing Current vs. V_{OUT} (Note 14)

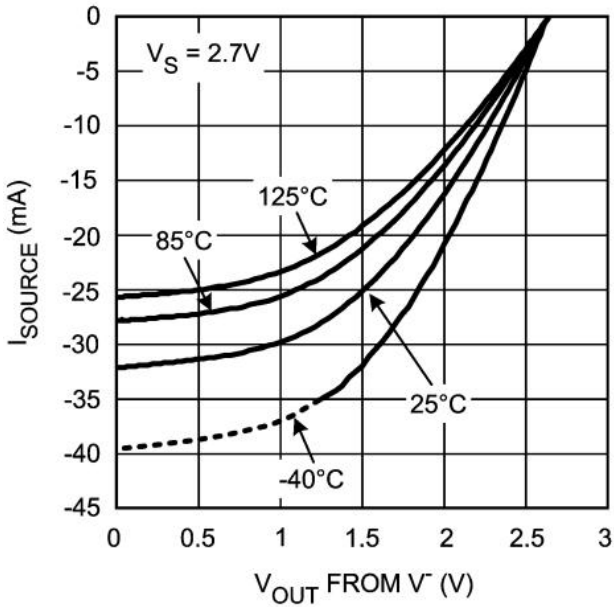

Sourcing Current vs. V_{OUT} (Note 14)

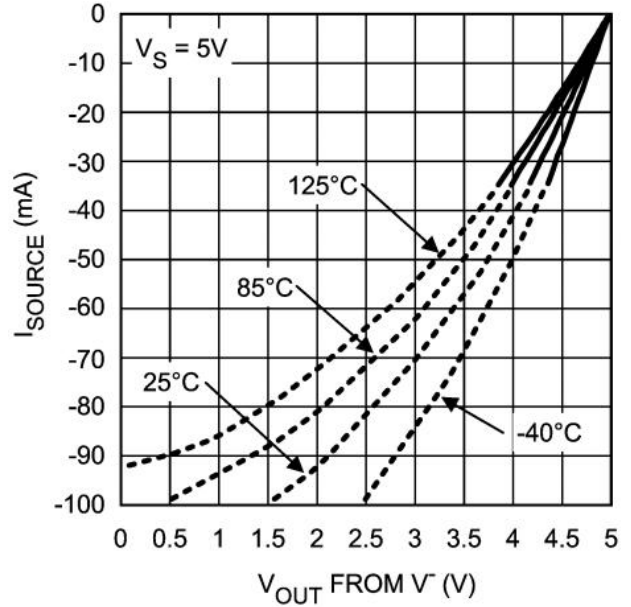

Sinking Current vs. V_{OUT} (Note 14)

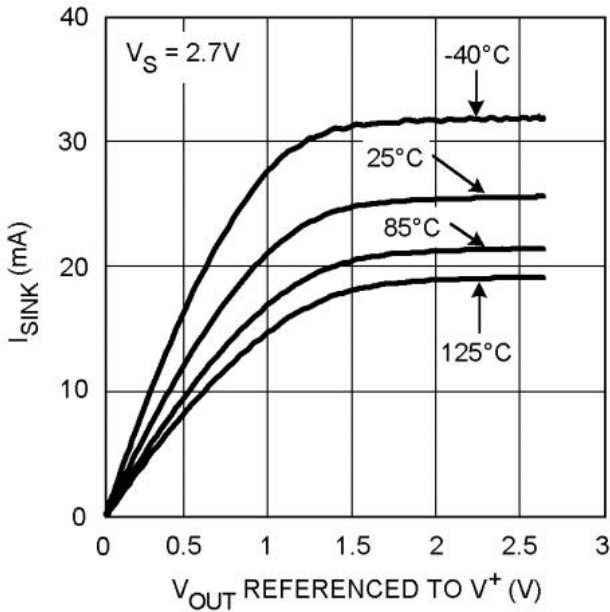

Sinking Current vs. V_{OUT} (Note 14)

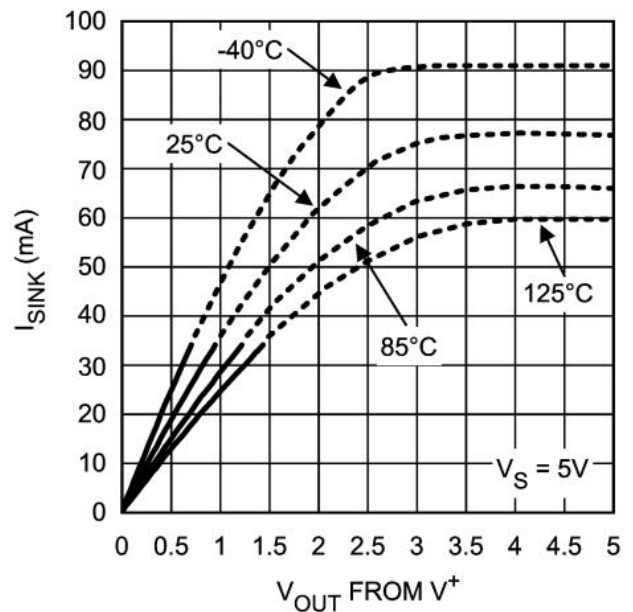

Input Voltage Noise vs. Frequency

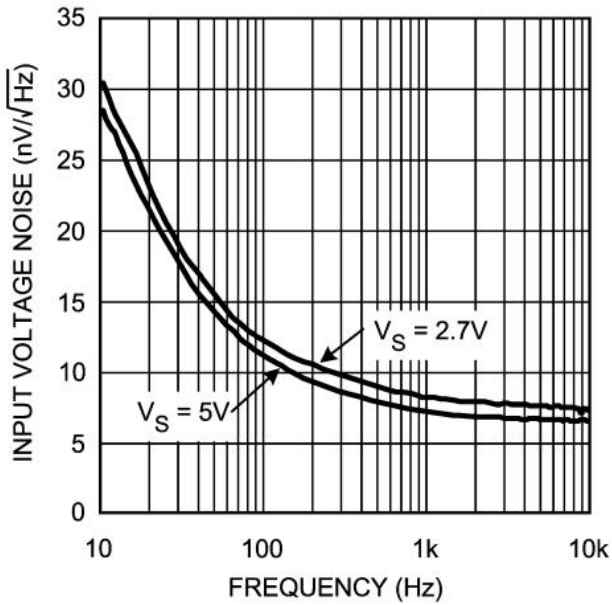

Input Bias Current Over Temperature

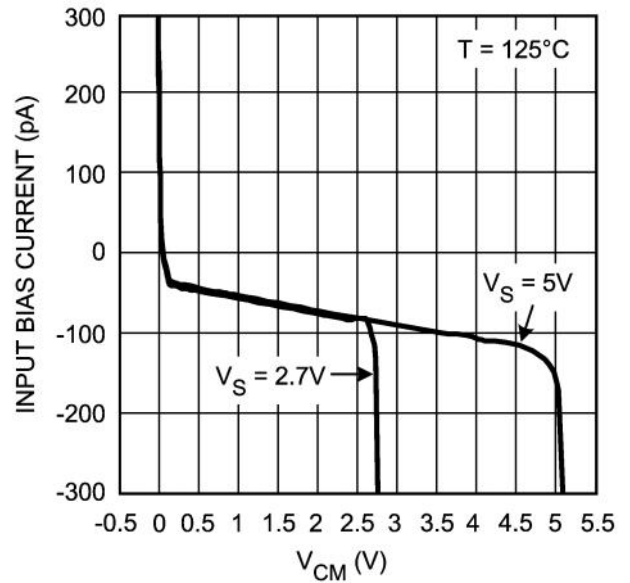

Input Bias Current Over Temperature

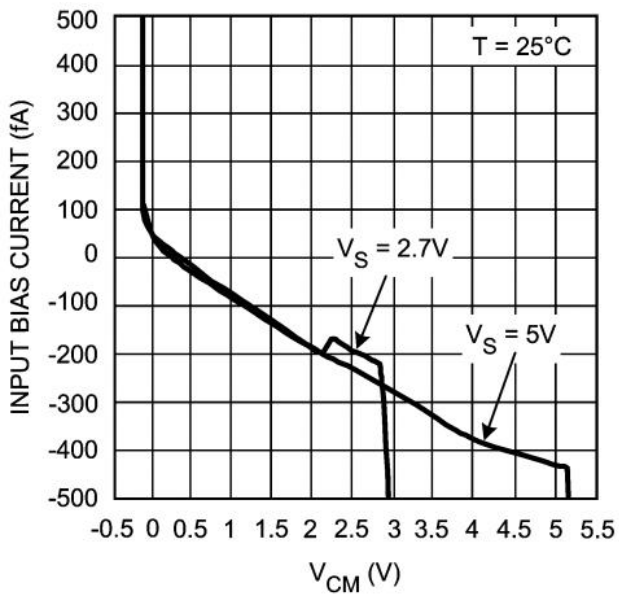

Input Bias Current Over Temperature

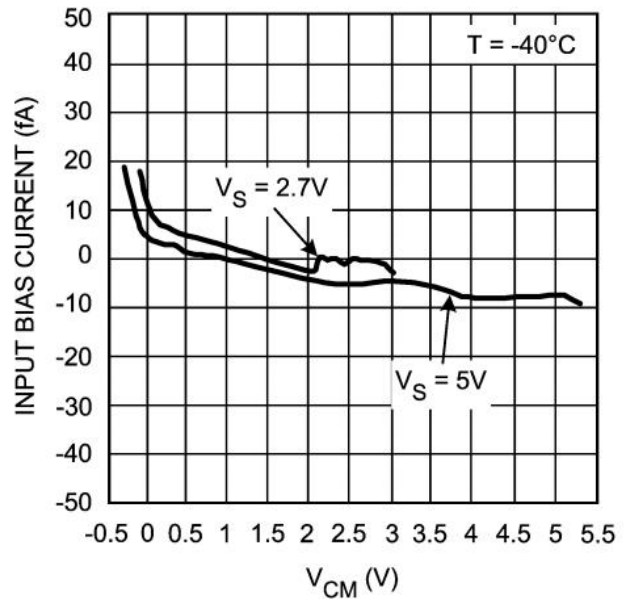

THD+N vs. Frequency

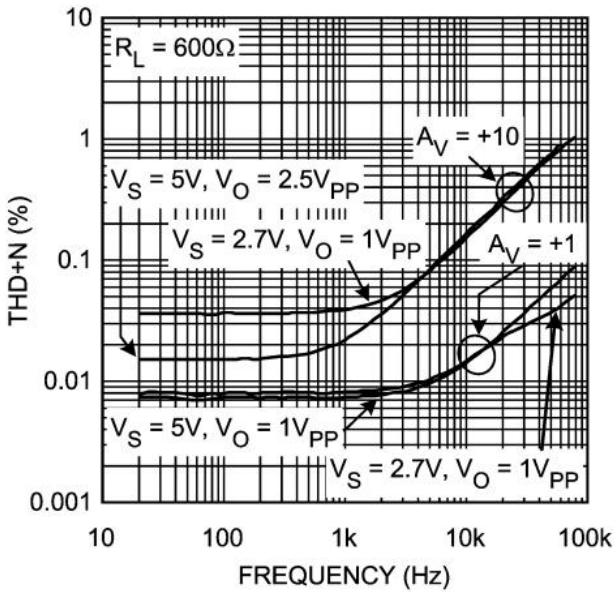

THD+N vs. V_{OUT}

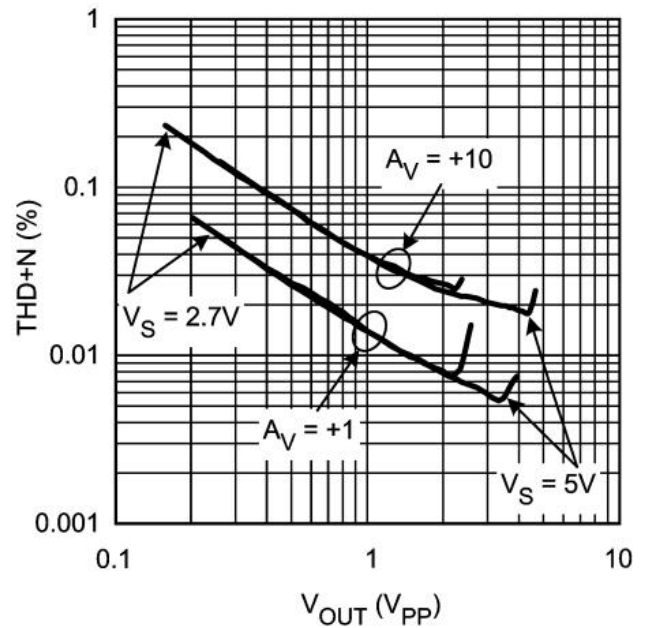

Slew Rate vs. Supply Voltage

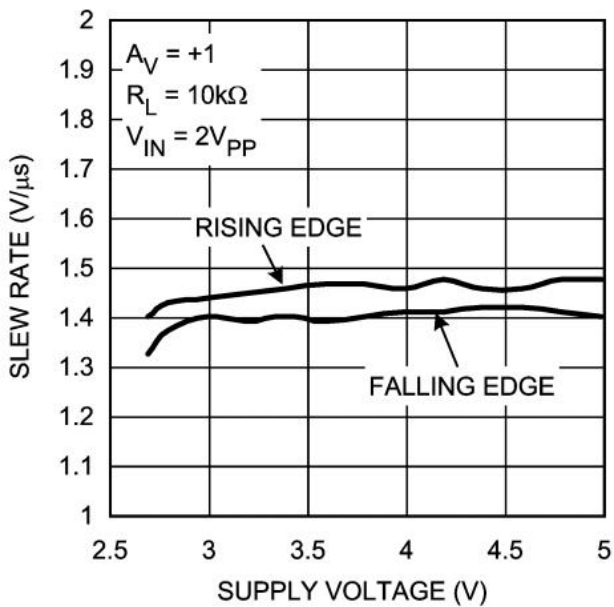

Open Loop Frequency Response Over Temperature

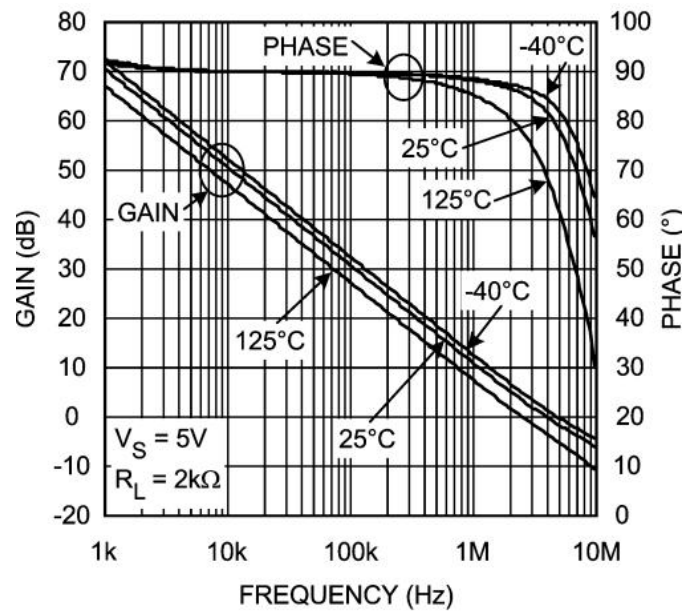

Open Loop Frequency Response

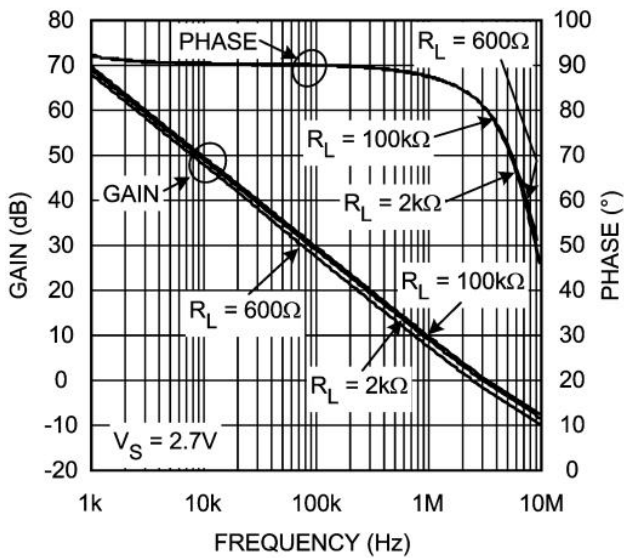

Open Loop Frequency Response

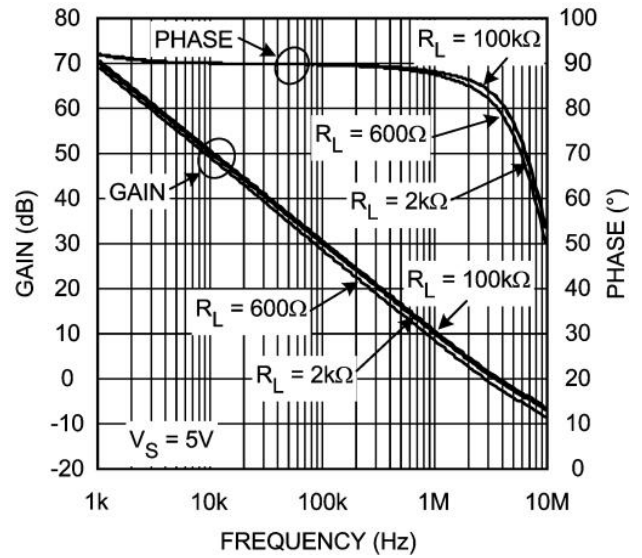

Open Loop Gain & Phase with Cap. Loading

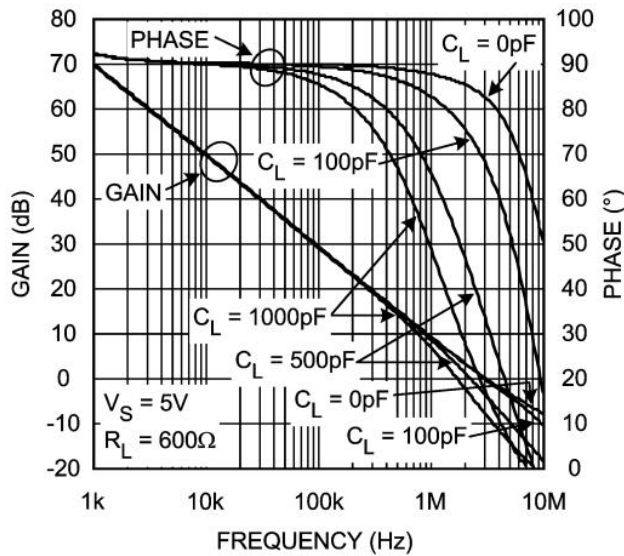

Open Loop Gain & Phase with Cap. Loading

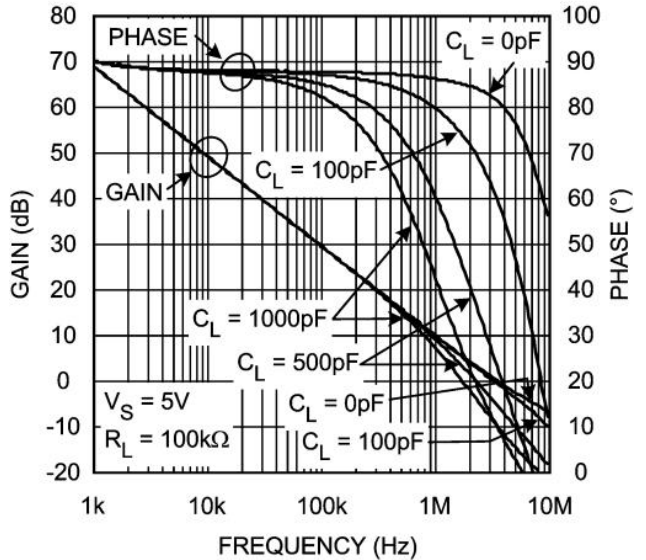

Non-Inverting Small Signal Pulse Response

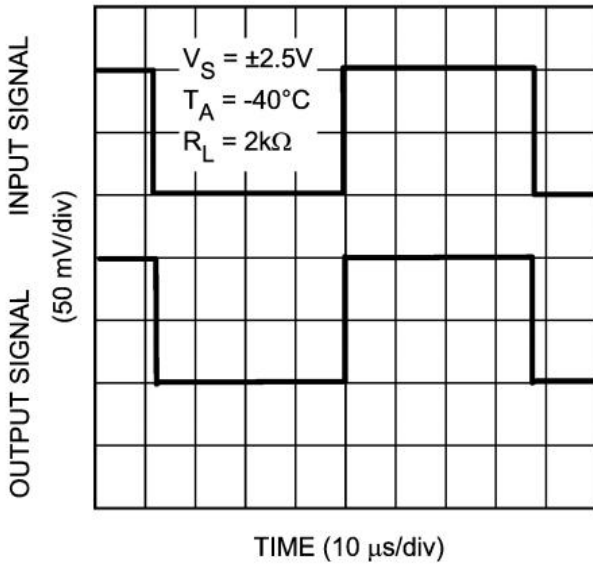

Non-Inverting Large Signal Pulse Response

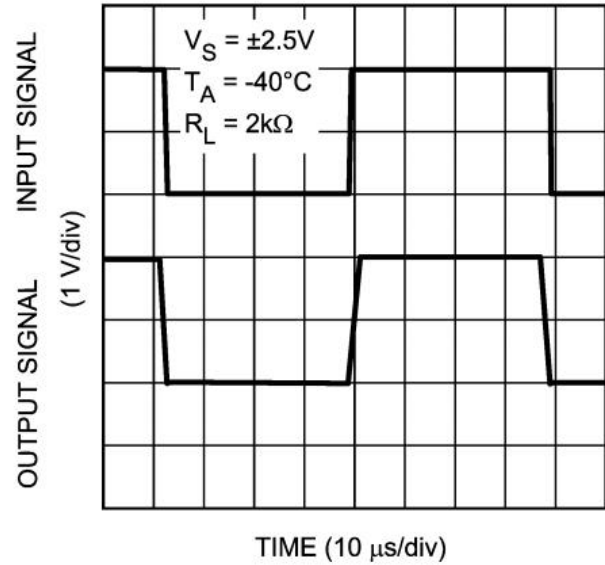

Non-Inverting Small Signal Pulse Response

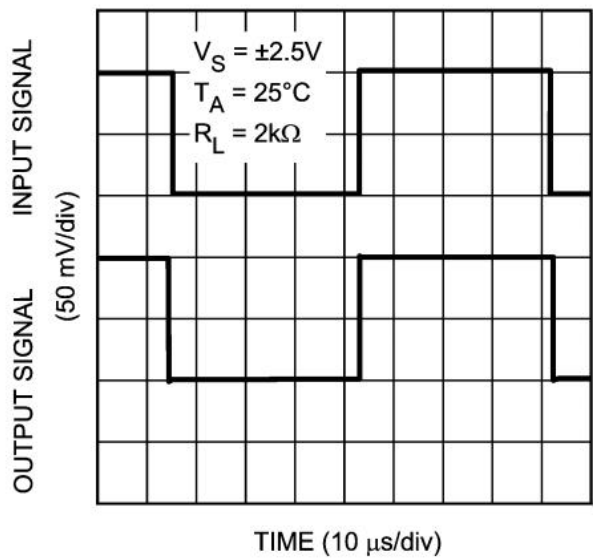

Non-Inverting Large Signal Pulse Response

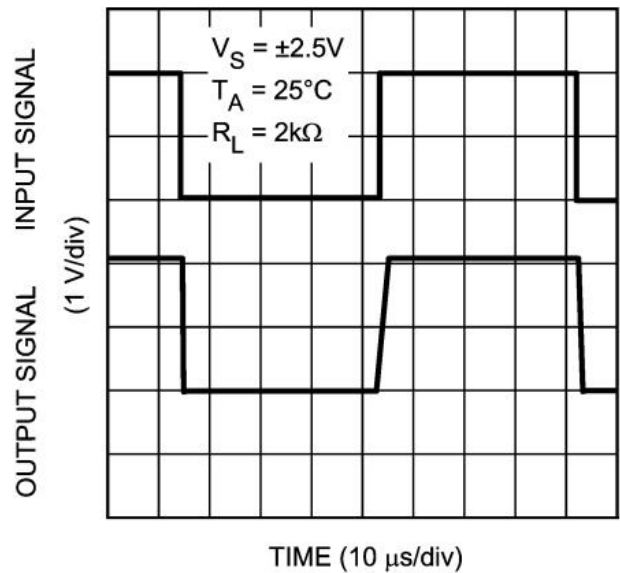

Non-Inverting Small Signal Pulse Response

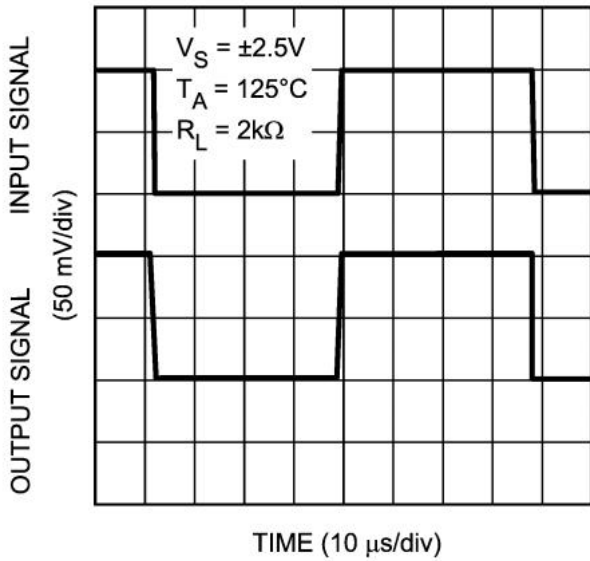

Non-Inverting Large Signal Pulse Response

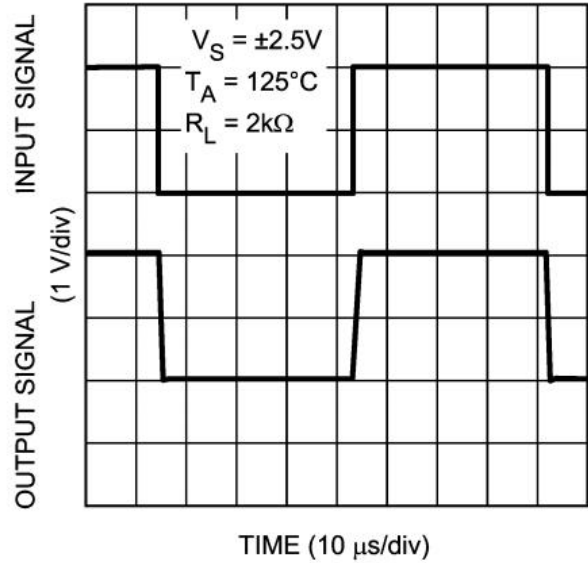

Inverting Small Signal Pulse Response

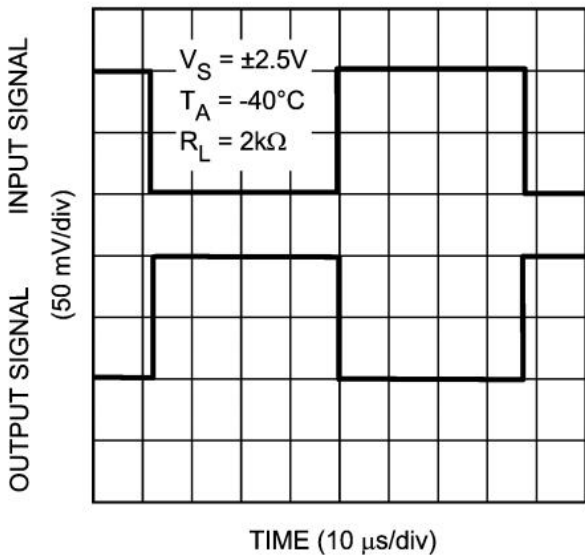

Inverting Large Signal Pulse Response

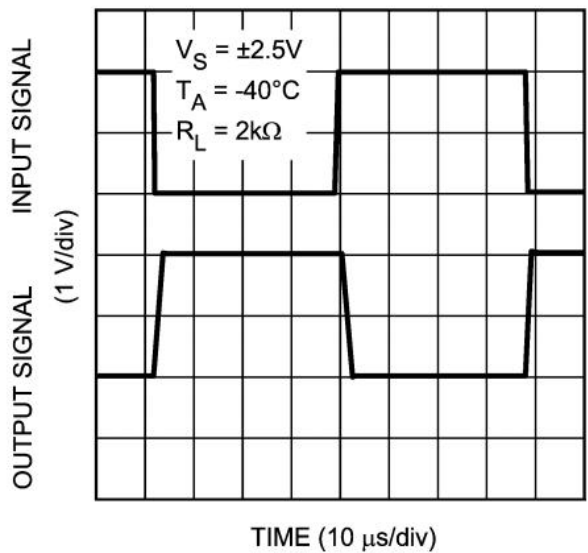

Inverting Small Signal Pulse Response

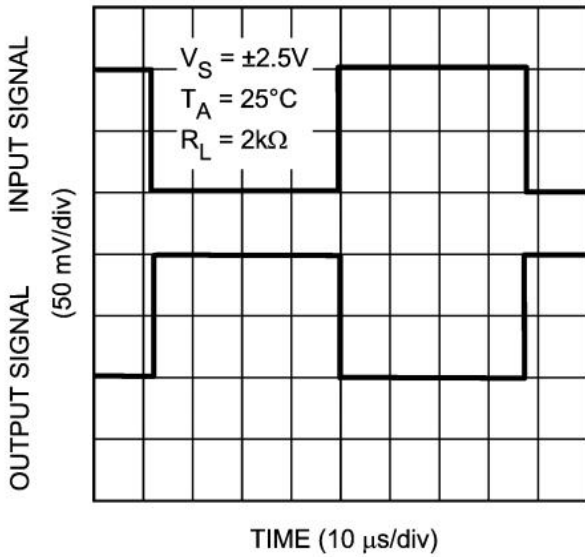

Inverting Large Signal Pulse Response

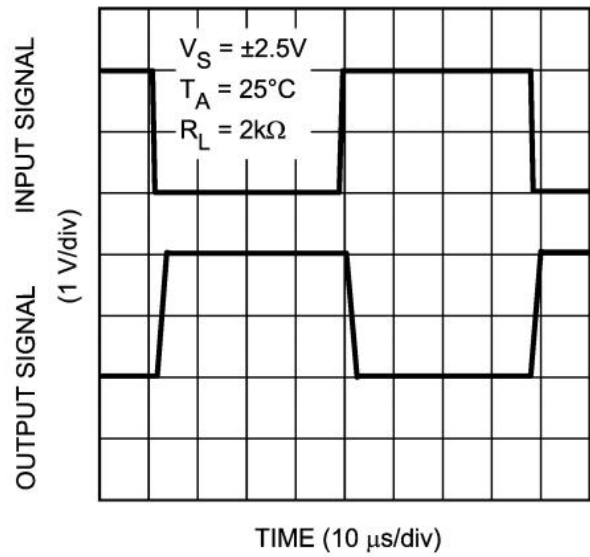

Inverting Small Signal Pulse Response

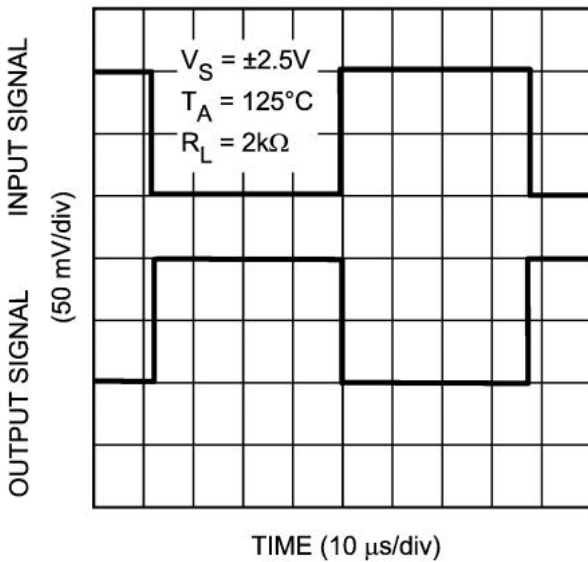

Inverting Large Signal Pulse Response

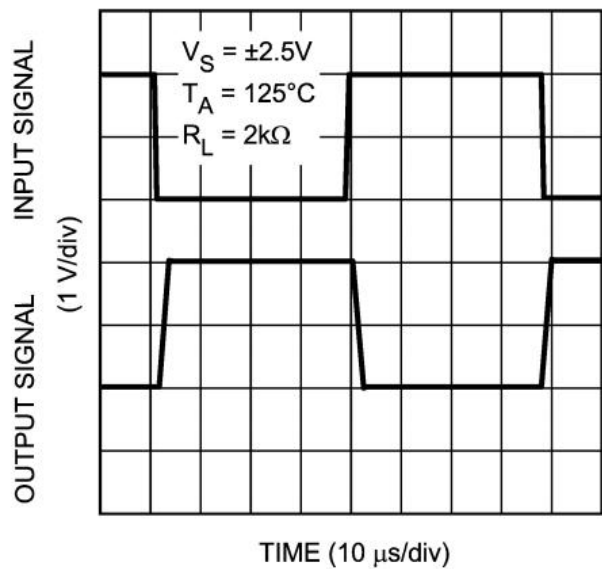

Stability vs. V_{CM}

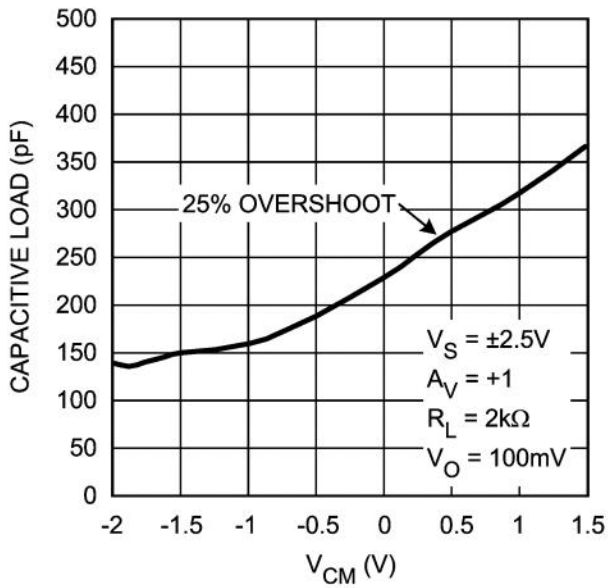

Stability vs. V_{CM}

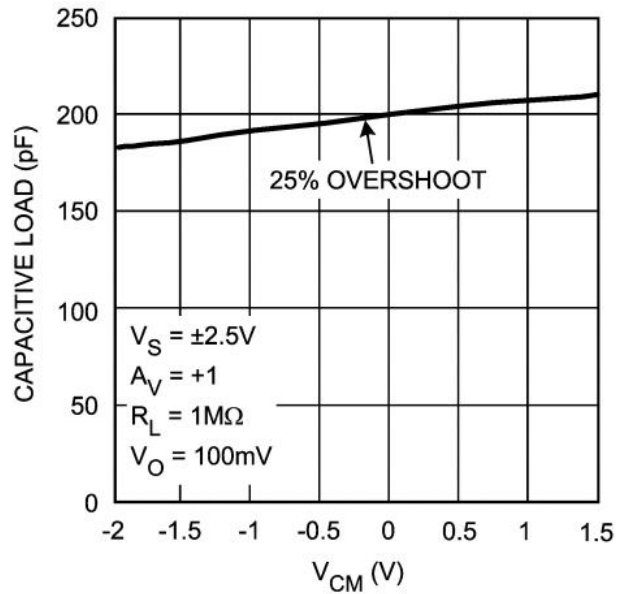

PSRR vs. Frequency

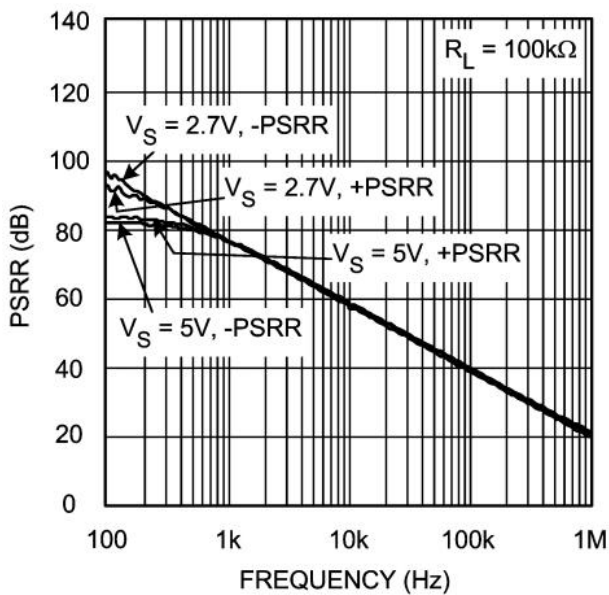

CMRR vs. Frequency

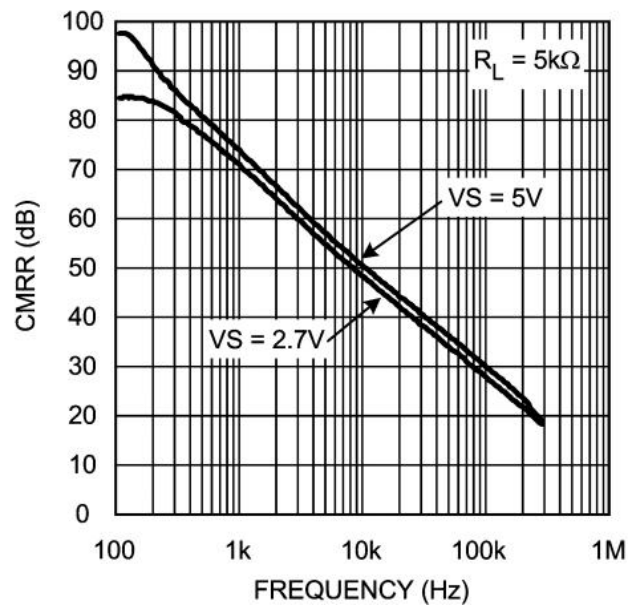

Crosstalk Rejection vs. Frequency

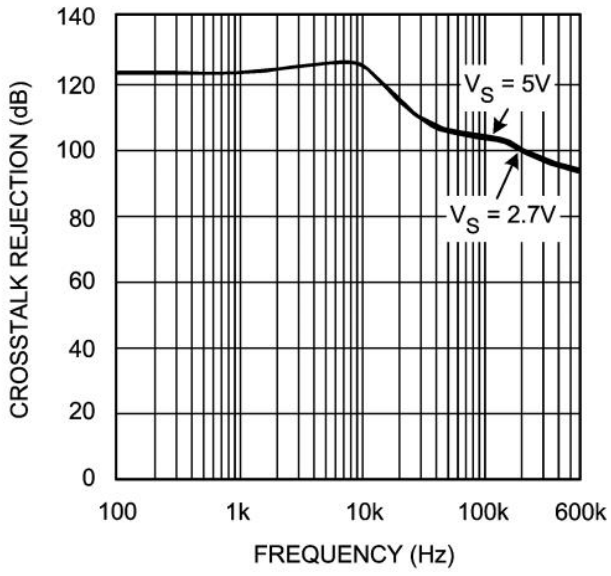

Application Note

The LMV771/ LMV772/ LMV774 is a family of precision amplifiers with very low noise and ultra low offset voltage. LMV771/ LMV772/ LMV774's extended temperature range of -40°C to 125°C enables the user to design this family of products in a variety of applications including automotive.

LMV771 has a maximum offset voltage of 1mV over the extended temperature range. This makes LMV771 ideal for applications where precision is of importance.

LMV772/ LMV774 have a maximum offset voltage of 1mV at room temperature and 1.2mV over the extended temperature range of -40°C to 125°C . Care must be given when LMV772/ LMV774 are designed in applications with heavy loads under extreme temperature conditions. As indicated in the DC tables, the LMV772 /LMV774's gain and output swing may be reduced at temperatures between 85°C and 125°C with loads heavier than $2\text{k}\Omega$.

INSTRUMENTATION AMPLIFIER

Measurement of very small signals with an amplifier requires close attention to the input impedance of the amplifier, gain of the overall signal on the inputs, and the gain on each input since we are only interested in the difference of the two inputs and the common signal is considered noise. A classic solution is an instrumentation amplifier. Instrumentation amplifiers have a finite, accurate, and stable gain. Also they have extremely high input impedances and very low output impedances. Finally they have an extremely high CMRR so that the amplifier can only respond to the differential signal. A typical instrumentation amplifier is shown in Figure 1.

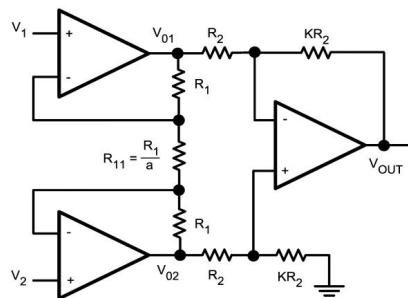

FIGURE 1.

There are two stages in this amplifier. The last stage, output stage, is a differential amplifier. In an ideal case the two amplifiers of the first stage, input stage, would be set up as buffers to isolate the inputs. However they cannot be connected as followers because of real amplifiers mismatch. That is why there is a balancing resistor between the two. The product of the two stages of the gain will give the gain of the instrumentation amplifier. Ideally, the CMRR should be infinity. However the output stage has a small non-zero common mode gain which results from resistor mismatch.

In the input stage of the circuit, current is the same across all resistors. This is due to the high input impedance and low input bias current of the LMV771. With the node equations we have:

$$\text{GIVEN: } I_{R1} = I_{R11} \tag{1}$$

By Ohm's Law:

$$\begin{aligned} V_{O1} - V_{O2} &= (2R_1 + R_{11})I_{R11} \\ &= (2a + 1)R_{11} \cdot I_{R11} \\ &= (2a + 1)V_{R11} \end{aligned} \tag{2}$$

However:

$$V_{R11} = V_1 - V_2 \tag{3}$$

So we have:

$$V_{O1}-V_{O2}=(2a+1)(V_1-V_2) \quad (4)$$

Now looking at the output of the instrumentation amplifier:

$$\begin{aligned} V_O &= \frac{KR_2}{R_2}(V_{O2} - V_{O1}) \\ &= -K(V_{O1} - V_{O2}) \end{aligned} \quad (5)$$

Substituting from equation 4:

$$V_O = -K(2a+1)(V_1 - V_2) \quad (6)$$

This shows the gain of the instrumentation amplifier to be:

$$-K(2a+1)$$

Typical values for this circuit can be obtained by setting: $a = 12$ and $K = 4$. This results in an overall gain of -100 . Figure 2 shows typical CMRR characteristics of this Instrumentation amplifier over frequency. Three LMV771 amplifiers are used along with 1% resistors to minimize resistor mismatch. Resistors used to build the circuit are: $R_1 = 21.6\text{k}\Omega$, $R_{11} = 1.8\text{k}\Omega$, $R_2 = 2.5\text{k}\Omega$ with $K = 40$ and $a = 12$. This results in an overall gain of -1000 , $-K(2a+1) = -1000$.

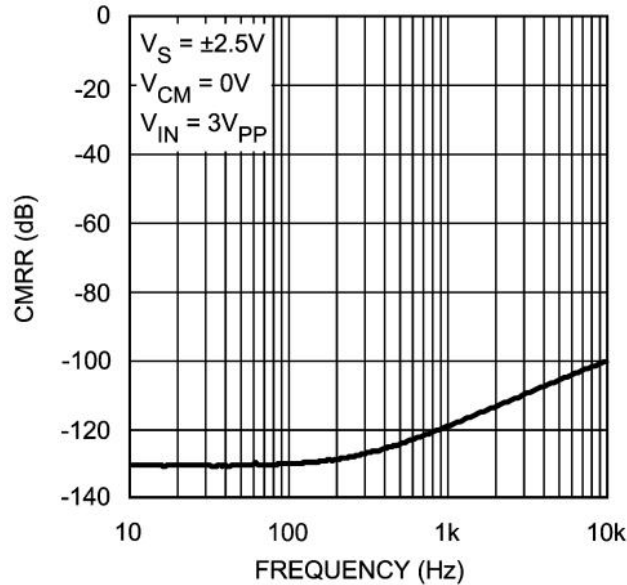

FIGURE 2. CMRR vs. Frequency

ACTIVE FILTER

Active Filters are circuits with amplifiers, resistors, and capacitors. The use of amplifiers instead of inductors, which are used in passive filters, enhances the circuit performance while reducing the size and complexity of the filter

The simplest active filters are designed using an inverting op amp configuration where at least one reactive element has been added to the configuration. This means that the op amp will provide "frequency-dependent" amplification, since reactive elements are frequency dependent devices.

LOW PASS FILTER

The following shows a very simple low pass filter.

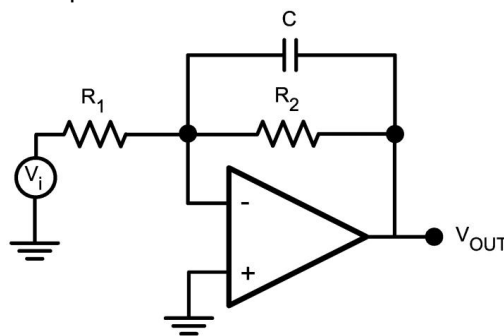

FIGURE 3.

The transfer function can be expressed as follows:

By KCL:

$$\frac{-V_i}{R_1} - \frac{V_o}{\left[\frac{1}{j\omega C} \right]} - \frac{V_o}{R_2} = 0 \quad (7)$$

Simplifying this further results in:

$$V_o = \frac{-R_2}{R_1} \left[\frac{1}{j\omega C R_2 + 1} \right] V_i \quad (8)$$

or

$$\frac{V_o}{V_i} = \frac{-R_2}{R_1} \left[\frac{1}{j\omega C R_2 + 1} \right] \quad (9)$$

Now, substituting $\omega = 2\pi f$, so that the calculations are in $f(\text{Hz})$ and not $\omega(\text{rad/s})$, and setting the DC

gain $\left[\frac{-R_2}{R_1} = H_o \right]$ and $H = \frac{V_o}{V_i}$

$$H = H_o \left[\frac{1}{j2\pi f C R_2 + 1} \right] \quad (10)$$

Set: $f_o = \frac{1}{2\pi R_2 C}$

$$H = H_o \left[\frac{1}{1 + j(f/f_o)} \right] \quad (11)$$

Low pass filters are known as lossy integrators because they only behave as an integrator at higher frequencies. Just by looking at the transfer function one can predict the general form of the bode plot. When the f/f_o ratio is small, the capacitor is in effect an open circuit and the amplifier behaves at a set DC gain. Starting at f_o , -3dB corner, the capacitor will have the dominant impedance and hence the circuit will behave as an integrator and the signal will be attenuated and eventually cut. The bode plot for this filter is shown in the following picture:

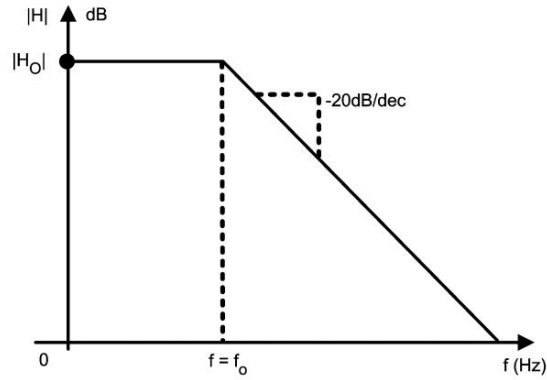

FIGURE 4

HIGH PASS FILTER

In a similar approach, one can derive the transfer function of a high pass filter. A typical first order high pass filter is shown below:

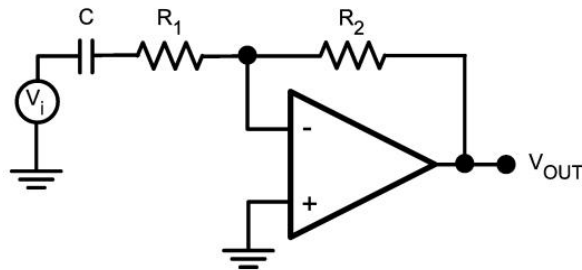

FIGURE 5.

Writing the KCL for this circuit : (V_1 denotes the voltage between C and R_1)

$$\frac{V_1 - V_i}{1} = \frac{V_1 - V^-}{R_1}$$

(12)

$$\frac{V^- + V_1}{R_1} = \frac{V^- + V_o}{R_2}$$

(13)

Solving these two equations to find the transfer function and using:

$$f_0 = \frac{1}{2\pi R_2 C}$$

(high frequency gain) $H_0 = \frac{-R_2}{R_1}$ and $H = \frac{V_o}{V_i}$

Which results: $H = H_0 \frac{j(f/f_0)}{1 + j(f/f_0)}$

(14)

Looking at the transfer function, it is clear that when f/f_0 is small, the capacitor is open and hence no signal is getting in to the amplifier. As the frequency increases the amplifier starts operating. At $f=f_0$ the capacitor behaves like a short circuit and the amplifier will have a constant, high frequency, gain of H_0 . The bode plot of the transfer function follows:

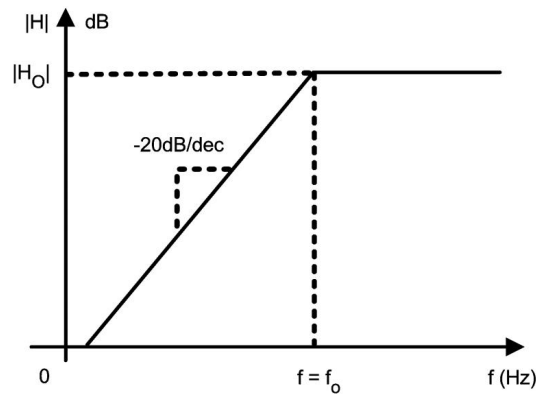

FIGURE 6.

BAND PASS FILTER

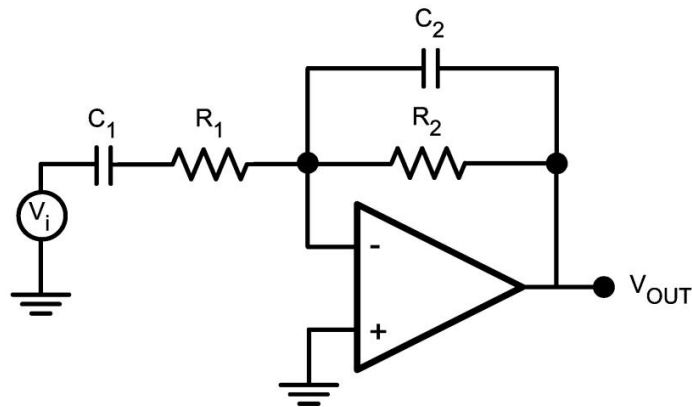

FIGURE 7.

Combining a low pass filter and a high pass filter will generate a band pass filter. In this network the input impedance forms the high pass filter while the feedback impedance forms the low pass filter. Choosing the corner frequencies so that $f_1 < f_2$, then all the frequencies in between, $f_1 \leq f \leq f_2$, will pass through the filter while frequencies below f_1 and above f_2 will be cut off.

The transfer function can be easily calculated using the same methodology as before.

$$H = H_0 \frac{j(f/f_1)}{[1 + j(f/f_1)][1 + j(f/f_2)]}$$

(15)

Where

$$f_1 = \frac{1}{2\pi R_1 C_1}$$

$$f_2 = \frac{1}{2\pi R_2 C_2}$$

$$H_0 = \frac{-R_2}{R_1}$$

The transfer function is presented in the following figure.

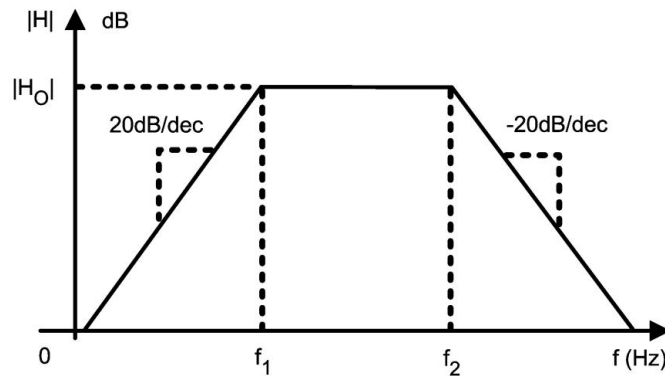

FIGURE 8.

STATE VARIABLE ACTIVE FILTER

State variable active filters are circuits that can simultaneously represent high pass, band pass, and low pass filters. The state variable active filter uses three separate amplifiers to achieve this task. A typical state variable active filter is shown in Figure 9. The first amplifier in the circuit is connected as a gain stage. The second and third amplifiers are connected as integrators, which means they behave as low pass filters. The feedback path from the output of the third amplifier to the first amplifier enables this low frequency signal to be fed back with a finite and fairly low closed loop gain. This is while the high frequency signal on the input is still gained up by the open loop gain of the 1st amplifier. This makes the first amplifier a high pass filter. The high pass signal is then fed in to a low pass filter. The outcome is a band pass signal, meaning the second amplifier is a band pass filter. This signal is then fed into the third amplifiers input and so the third amplifier behaves as a simple low pass filter.

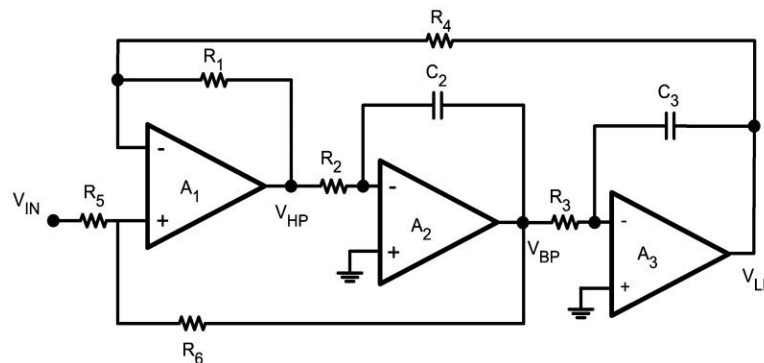
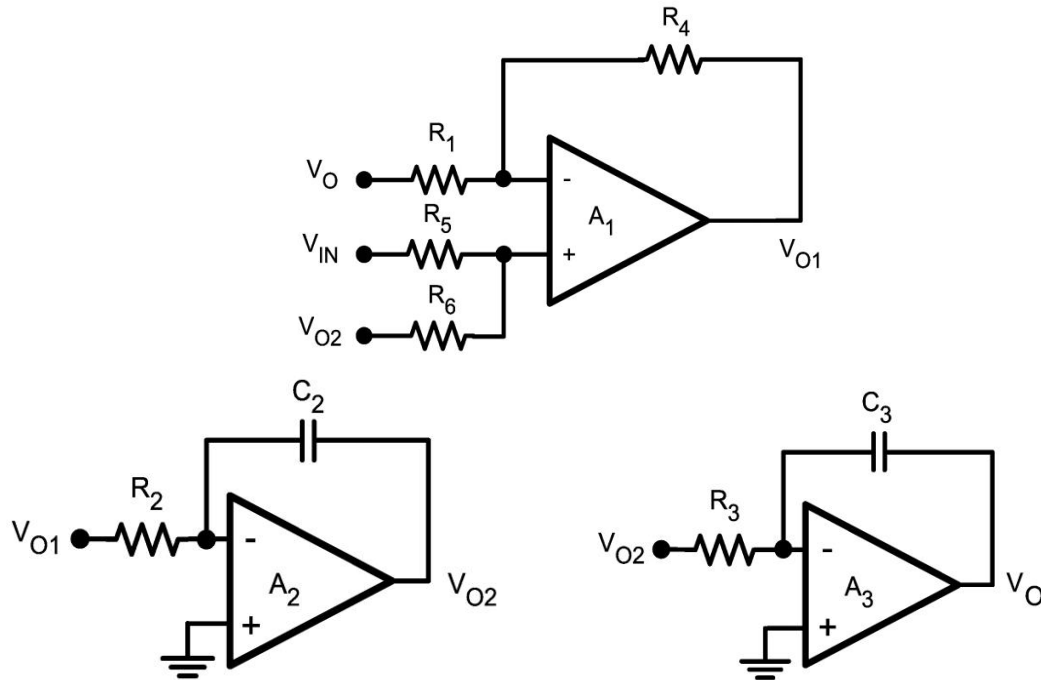

FIGURE 9.

The transfer function of each filter needs to be calculated. The derivations will be more trivial if each stage of the filter is shown on its own.

The three components are:



For A1 the relationship between input and output is:

$$V_{O1} = \frac{-R_4}{R_1} V_O + \left[\frac{R_6}{R_5 + R_6} \right] \left[\frac{R_1 + R_4}{R_1} \right] V_{IN} + \left[\frac{R_5}{R_5 + R_6} \right] \left[\frac{R_1 + R_4}{R_1} \right] V_{O2}$$

This relationship depends on the output of all the filters. The input-output relationship for A2 can be expressed as:

$$V_{O2} = \frac{-1}{sC_2R_2} V_{O1}$$

And finally this relationship for A3 is as follows:

$$V_O = \frac{-1}{sC_3R_3} V_{O2}$$

Re-arranging these equations, one can find the relationship between V_O and V_{IN} (transfer function of the lowpass filter), V_{O1} and V_{IN} (transfer function of the highpass filter), and V_{O2} and V_{IN} (transfer function of the bandpass filter) These relationships are as follows:

Lowpass filter

$$\frac{V_O}{V_{IN}} = \frac{\left[\frac{R_1 + R_4}{R_1} \right] \left[\frac{R_6}{R_5 + R_6} \right] \left[\frac{1}{C_2 C_3 R_2 R_3} \right]}{S^2 + S \left[\frac{1}{C_2 R_2} \right] \left[\frac{R_5}{R_5 + R_6} \right] \left[\frac{R_1 + R_4}{R_1} \right] + \left[\frac{1}{C_2 C_3 R_2 R_3} \right]}$$

Highpass filter

$$\frac{V_{O1}}{V_{IN}} = \frac{S^2 \left[\frac{R_1 + R_4}{R_1} \right] \left[\frac{R_6}{R_5 + R_6} \right]}{S^2 + S \left[\frac{1}{C_2 R_2} \right] \left[\frac{R_5}{R_5 + R_6} \right] \left[\frac{R_1 + R_4}{R_1} \right] + \left[\frac{1}{C_2 C_3 R_2 R_3} \right]}$$

Bandpass Filter

$$\frac{V_{O2}}{V_{IN}} = \frac{S \left[\frac{1}{C_2 R_2} \right] \left[\frac{R_1 + R_4}{R_1} \right] \left[\frac{R_6}{R_5 + R_6} \right]}{S^2 + S \left[\frac{1}{C_2 R_2} \right] \left[\frac{R_5}{R_5 + R_6} \right] \left[\frac{R_1 + R_4}{1} \right] + \left[\frac{1}{C_2 C_3 R_2 R_3} \right]}$$

The center frequency and quality factor for all of these filters is the same. The values can be calculated in the following manner:

$$\omega_c = \sqrt{\frac{1}{C_2 C_3 R_2 R_3}}$$

and

$$Q = \sqrt{\frac{C_2 R_2}{C_3 R_3} \left[\frac{R_5 + R_6}{R_6} \right] \left[\frac{R_1}{R_1 + R_4} \right]}$$

A design example is shown here:

Designing a bandpass filter with center frequency of 10kHz and Quality factor of 5.5

To do this, first consider the quality factor. It is best to pick convenient values for the capacitors. $C_2 = C_3 = 1000\text{pF}$. Also, choose $R_1 = R_4 = 30\text{k}\Omega$. Now Values of R_5 and R_6 need to be calculated. With the chosen values for the capacitors and resistors, Q reduces to:

$$Q = \frac{11}{2} = \frac{1}{2} \left[\frac{R_5 + R_6}{R_6} \right]$$

Or

$$\begin{aligned} R_5 &= 10R_6 \\ R_6 &= 1.5\text{k}\Omega \\ R_5 &= 15\text{k}\Omega \end{aligned}$$

Also, for $f = 10\text{kHz}$, value of center frequency is $\omega_c = 2\pi f = 62.8\text{kHz}$.

Using the expressions above, the appropriate resistor values will be $R_2 = R_3 = 16\text{k}\Omega$.

The following graphs show the transfer function of each of the filters. The DC gain of this circuit is:

$$\text{DC GAIN} = \left[\frac{R_1 + R_4}{R_1} \right] \left[\frac{R_6}{R_5 + R_6} \right] = -14.8\text{dB}$$

The following graphics show the frequency response of each of the stages when using LMV774 as the amplifier:

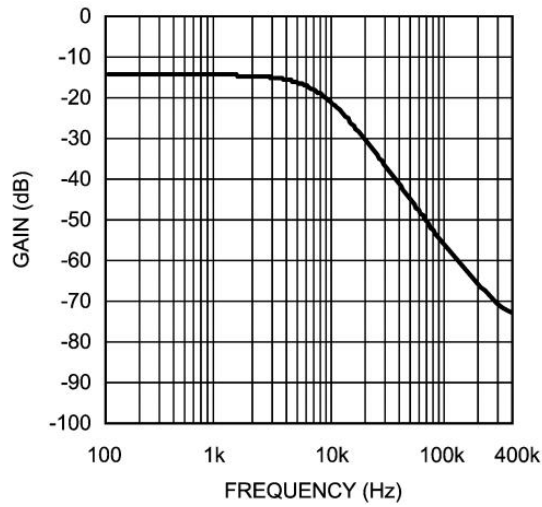

FIGURE 10. Lowpass Filter Frequency Response

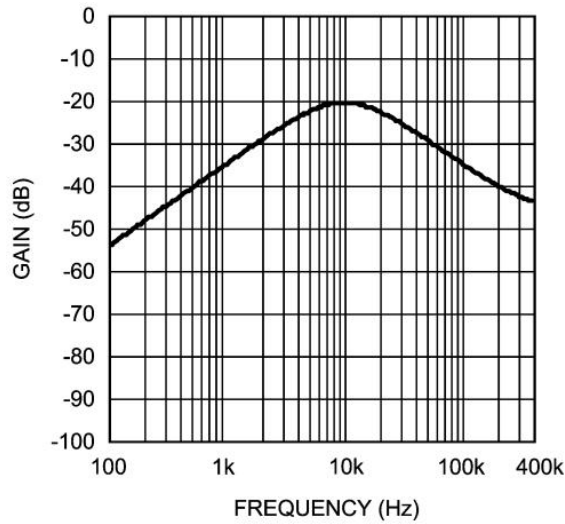

FIGURE 11. Bandpass Filter Frequency Response

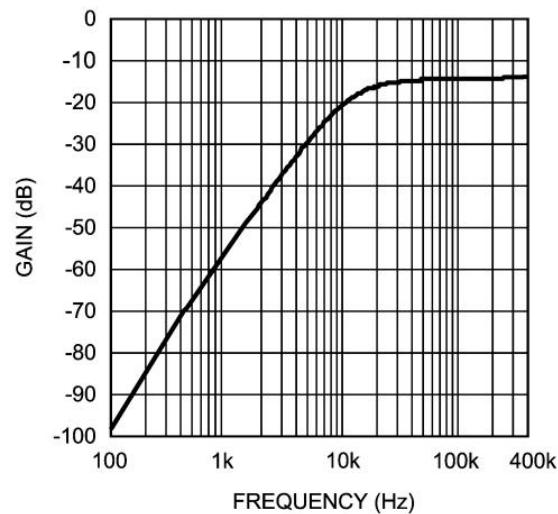
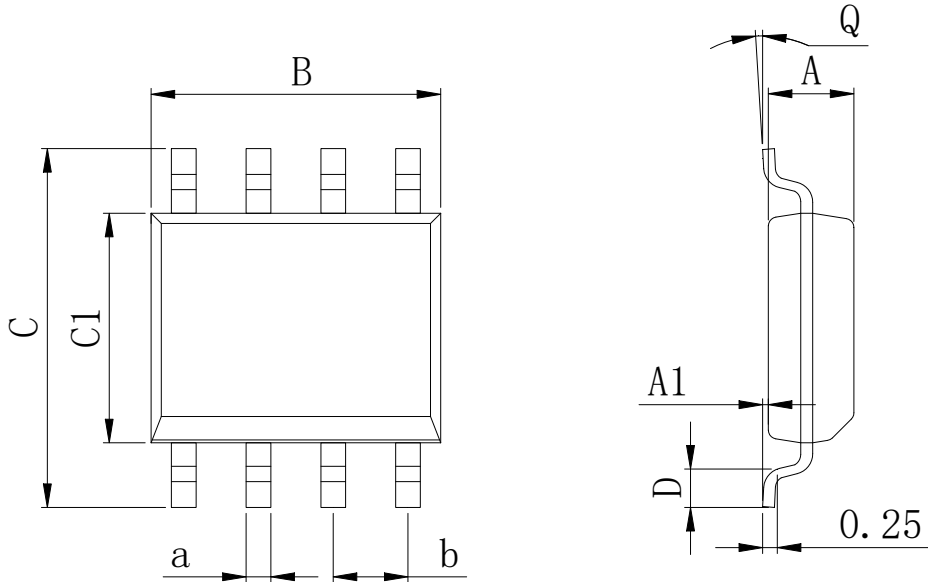

FIGURE 12. Highpass Filter Frequency Response

Physical Dimensions

SOP-8 (150mil)



Dimensions In Millimeters(SOP-8)

Symbol:	A	A1	B	C	C1	D	Q	a	b
Min:	1.35	0.05	4.90	5.80	3.80	0.40	0°	0.35	1.27 BSC
Max:	1.55	0.20	5.10	6.20	4.00	0.80	8°	0.45	

MSOP-8

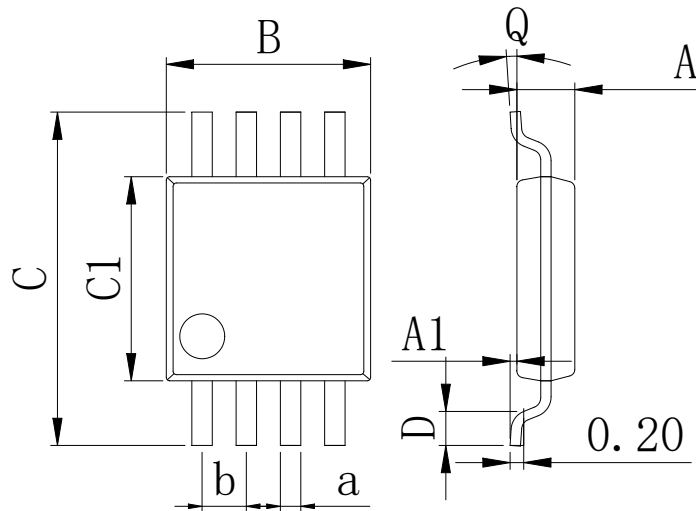

Dimensions In Millimeters(MSOP-8)

Symbol:	A	A1	B	C	C1	D	Q	a	b
Min:	0.80	0.05	2.90	4.75	2.90	0.35	0°	0.25	0.65 BSC
Max:	0.90	0.20	3.10	5.05	3.10	0.75	8°	0.35	

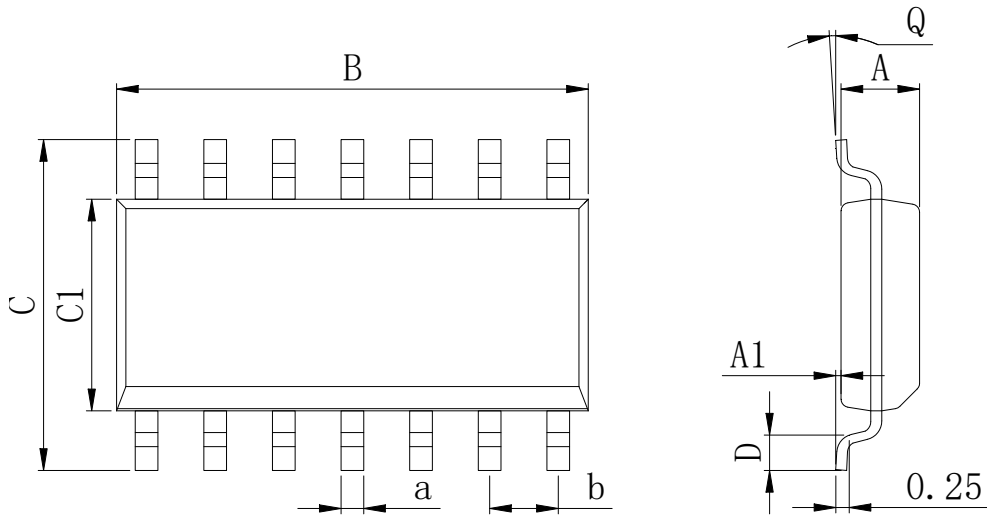
Physical Dimensions
SOP-14

Dimensions In Millimeters(SOP-14)

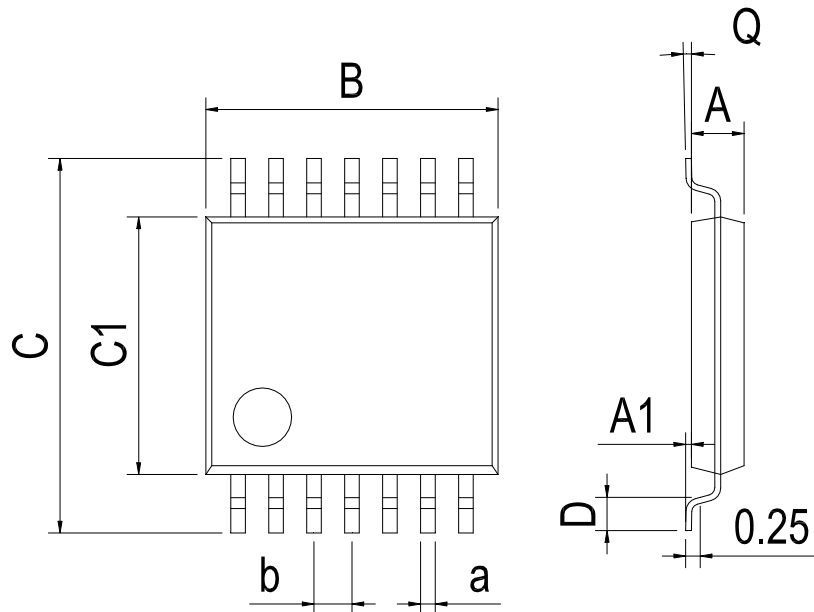
Symbol:	A	A1	B	C	C1	D	Q	a	b
Min:	1.35	0.05	8.55	5.80	3.80	0.40	0°	0.35	1.27 BSC
Max:	1.55	0.20	8.75	6.20	4.00	0.80	8°	0.45	

TSSOP-14

Dimensions In Millimeters(TSSOP-14)

Symbol:	A	A1	B	C	C1	D	Q	a	b
Min:	0.85	0.05	4.90	6.20	4.30	0.40	0°	0.20	0.65 BSC
Max:	0.95	0.20	5.10	6.60	4.50	0.80	8°	0.25	

Physical Dimensions

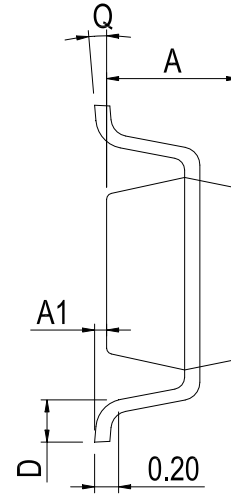
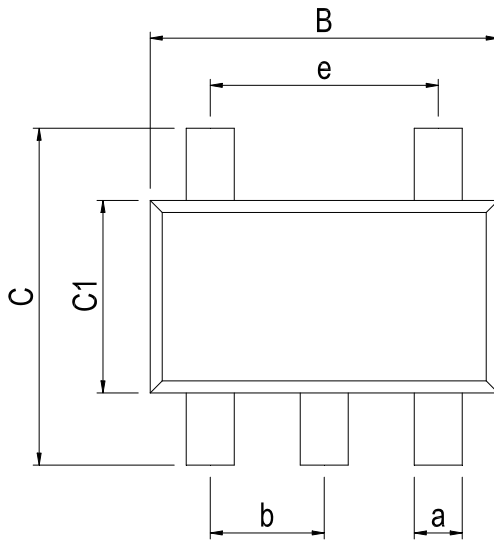
SC70-5



Dimensions In Millimeters(SC70-5)										
Symbol:	A	A1	B	C	C1	D	Q	a	b	e
Min:	0.90	0.00	2.00	2.15	1.15	0.26	0°	0.15	0.65	1.30 BSC
Max:	1.00	0.15	2.20	2.45	1.35	0.46	8°	0.35	BSC	

Revision History

DATE	REVISION	PAGE
2014-6-5	New	1-33
2023-10-30	Add annotation for Maximum Ratings、 Update SC70-5 Physical Dimensions	4、 31

IMPORTANT STATEMENT:

Huaguan Semiconductor reserves the right to change its products and services without notice. Before ordering, the customer shall obtain the latest relevant information and verify whether the information is up to date and complete. Huaguan Semiconductor does not assume any responsibility or obligation for the altered documents.

Customers are responsible for complying with safety standards and taking safety measures when using Huaguan Semiconductor products for system design and machine manufacturing. You will bear all the following responsibilities: Select the appropriate Huaguan Semiconductor products for your application; Design, validate and test your application; Ensure that your application meets the appropriate standards and any other safety, security or other requirements. To avoid the occurrence of potential risks that may lead to personal injury or property loss.

Huaguan Semiconductor products have not been approved for applications in life support, military, aerospace and other fields, and Huaguan Semiconductor will not bear the consequences caused by the application of products in these fields. All problems, responsibilities and losses arising from the user's use beyond the applicable area of the product shall be borne by the user and have nothing to do with Huaguan Semiconductor, and the user shall not claim any compensation liability against Huaguan Semiconductor by the terms of this Agreement.

The technical and reliability data (including data sheets), design resources (including reference designs), application or other design suggestions, network tools, safety information and other resources provided for the performance of semiconductor products produced by Huaguan Semiconductor are not guaranteed to be free from defects and no warranty, express or implied, is made. The use of testing and other quality control technologies is limited to the quality assurance scope of Huaguan Semiconductor. Not all parameters of each device need to be tested.

The documentation of Huaguan Semiconductor authorizes you to use these resources only for developing the application of the product described in this document. You have no right to use any other Huaguan Semiconductor intellectual property rights or any third party intellectual property rights. It is strictly forbidden to make other copies or displays of these resources. You should fully compensate Huaguan Semiconductor and its agents for any claims, damages, costs, losses and debts caused by the use of these resources. Huaguan Semiconductor accepts no liability for any loss or damage caused by infringement.