

SuperMOS –PDFN5*6-8L 30V BV_{DSS} , 10m Ω $R_{DS(on)}$, N-channel MOSFET

1. Description

The ESN6204 is N-Channel enhancement MOS Field Effect Transistor. Uses advanced trench technology and design to provide excellent $R_{DS(ON)}$ with low gate charge. Device is suitable for use in DC-DC conversion, power switch and charging circuit. Standard Product ESN6204 is Pb-free.

2. Features

- 30V, $R_{DS(ON)}=10.0m\Omega(TYP.) @V_{GS}=10V$
- $R_{DS(ON)}=13.5m\Omega(TYP.) @V_{GS}=4.5V$
- Use trench MOSFET technology
- High density cell design for low $R_{DS(on)}$
- Material: Halogen free
- Reliable and rugged
- Avalanche Rated
- Low leakage current

3. Applications

- PWM applications
- Load switch
- Power management in portable/desktop PCs
- DC/DC conversion

100% UIS TESTED

4. Ordering Information

Part Number	Package	Marking	Material	Packing	Quantity per reel	Flammability Rating	Reel Size
ESN6204	PDFN5*6-8L	ESN6204/lot	Halogen free	Tape & Reel	5,000 PCS	UL 94V-0	13 inches

Table-1 Ordering information

5. Pin Configuration and Functions

Pin	Function	Outline	Circuit Diagram
1/2/3	Source		
4	Gate		
5/6/7/8	Drain		

Table-2 Pin configuration

6. Specification

Absolute Maximum Rating & Thermal Characteristics

Ratings at 25 °C ambient temperature unless otherwise specified.

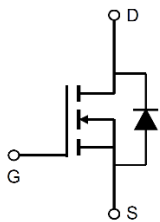
Parameter		Symbol	Limit	Unit
Drain-Source Voltage		BV_{DSS}	30	V
Gate-Source Voltage		V_{GS}	± 20	V
Continuous Drain Current	$T_C=25^\circ\text{C}$	I_D	32	A
	$T_C=75^\circ\text{C}$		24	
Maximum Power Dissipation	$T_C=25^\circ\text{C}$	P_D	31	W
	$T_C=75^\circ\text{C}$		19	
Pulsed Drain Current		I_{DM}	120	A
Avalanche Current, Single Pulsed ^a		I_{AS}	17	A
Avalanche Energy, Single Pulsed ^a		E_{AS}	43.4	mJ
Operating Junction Temperature		T_J	150	°C
Lead Temperature		T_L	260	°C
Storage Temperature Range		T_{stg}	-55 to 150	°C

Thermal resistance ratings

Single Operation					
Parameter		Symbol	Typical	Maximum	Unit
Junction-to-Case Thermal Resistance	$t \leq 10 \text{ s}$	$R_{\theta JC}$	3.3	4	°C/W

Note:

a: EAS condition: $T_J=25^\circ\text{C}$, $V_{DD}=30\text{V}$, $V_G=10\text{V}$, $L=0.3\text{mH}$, $R_g=25\Omega$

Electrical Characteristics

At TA = 25°C unless otherwise specified

Parameter	Symbol	Test Conditions	Min.	Typ.	Max.	Unit
OFF CHARACTERISTICS						
Drain-to-Source Breakdown Voltage	BV_{DSS}	$V_{GS}=0V, I_D=250\mu A$	30			V
Zero Gate Voltage Drain Current	I_{DSS}	$V_{DS}=30V, V_{GS}=0V$			1.0	μA
Gate-to-source Leakage Current	I_{GSS}	$V_{DS}=0V, V_{GS}=\pm 20V$			± 100	nA
ON CHARACTERISTICS						
Gate Threshold Voltage	$V_{GS(TH)}$	$V_{GS}=V_{DS}, I_D=250\mu A$	1.0	1.5	2.4	V
Drain-to-source On-resistance	$R_{DS(on)}$	$V_{GS}=10V, I_D=20A$		10	19	m Ω
		$V_{GS}=4.5V, I_D=15A$		13.5	26	
Forward Trans conductance	g_{FS}	$V_{DS}=5.0V, I_D=20A$			50	S
CHARGES, CAPACITANCES AND GATE RESISTANCE						
Input Capacitance	C_{ISS}	$V_{GS}=0V, f=1MHz,$ $V_{DS}=15V$		512		pF
Output Capacitance	C_{OSS}			225		
Reverse Transfer Capacitance	C_{RSS}			22		
Total Gate Charge	$Q_{G(TOT)}$	$V_{GS}=10V, V_{DS}=15V,$ $I_D=20A$		8		nC
Gate-to-Source Charge	Q_{GS}			2		
Gate-to-Drain Charge	Q_{GD}			1.5		
SWITCHING CHARACTERISTICS						
Turn-On Delay Time	$t_{d(ON)}$	$V_{GS}=10V, V_{DS}=15V,$ $R_L=1.5\Omega, R_{GEN}=3\Omega$		4.4		ns
Rise Time	t_r			7.9		
Turn-Off Delay Time	$t_{d(OFF)}$			15.6		
Fall Time	t_f			3.5		
BODY DIODE CHARACTERISTICS						
Forward Voltage	V_{SD}	$V_{GS}=0V, I_S=1.0A$	0.45		1.2	V

7. Typical Characteristic

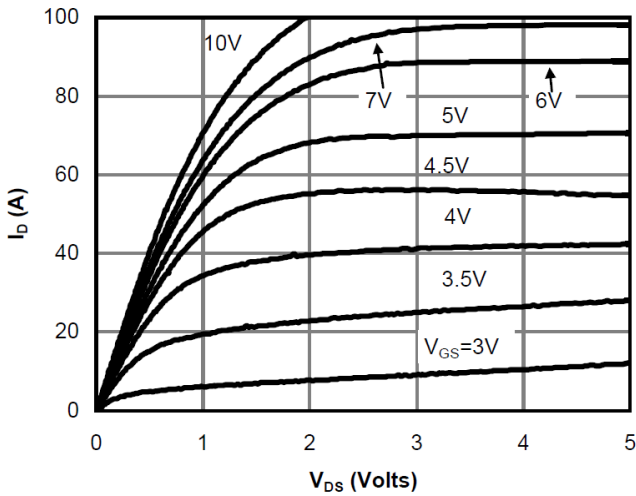

Fig 1: On-Region Characteristics

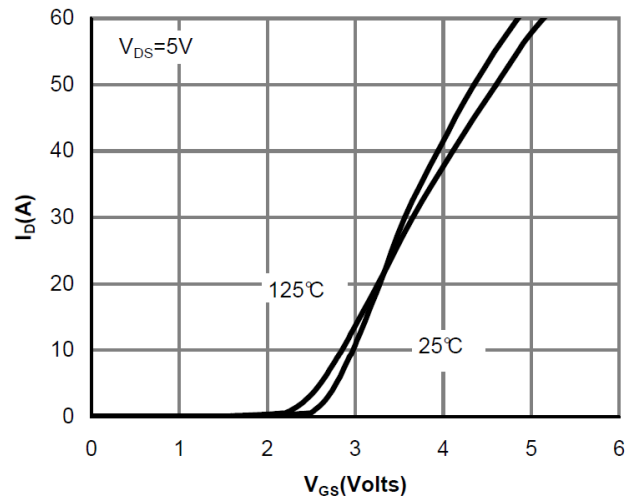

Figure 2: Transfer Characteristics

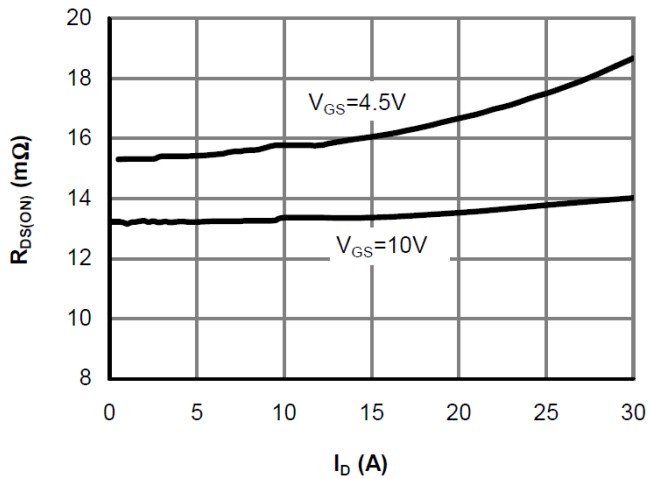

Figure 3: On-Resistance vs. Drain Current and Gate Voltage

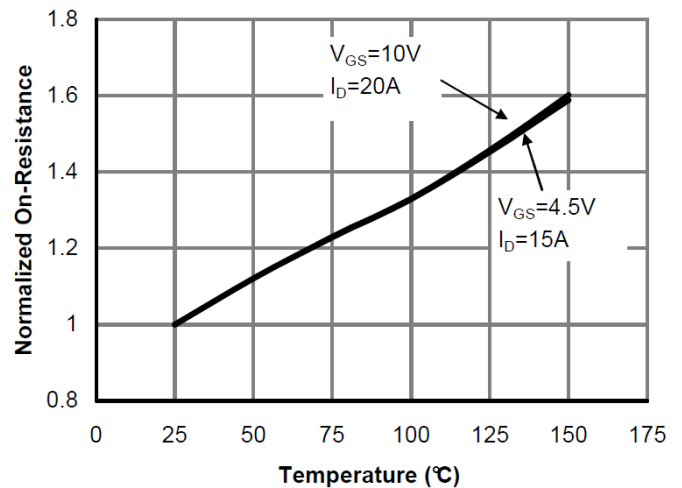

Figure 4: On-Resistance vs. Junction Temperature

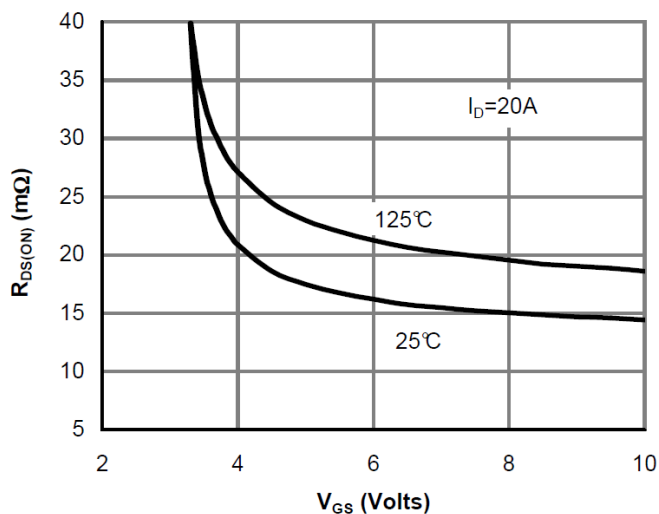

Figure 5: On-Resistance vs. Gate-Source Voltage

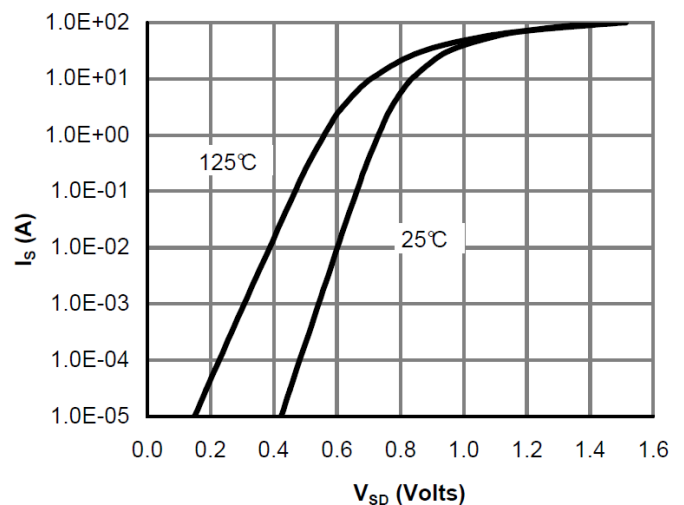

Figure 6: Body-Diode Characteristics

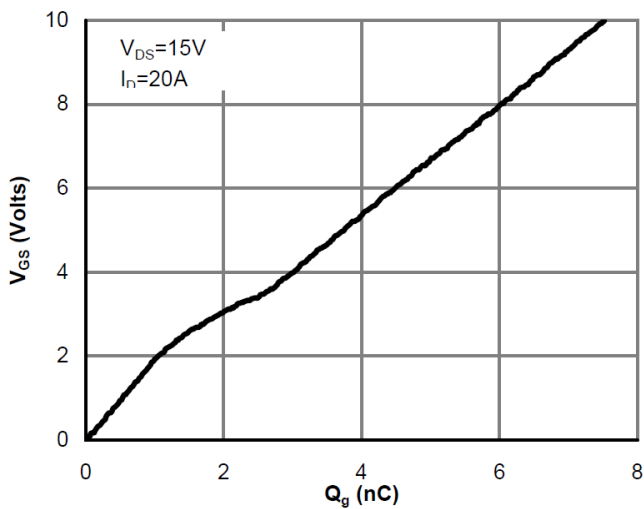

Figure 7: Gate-Charge Characteristics

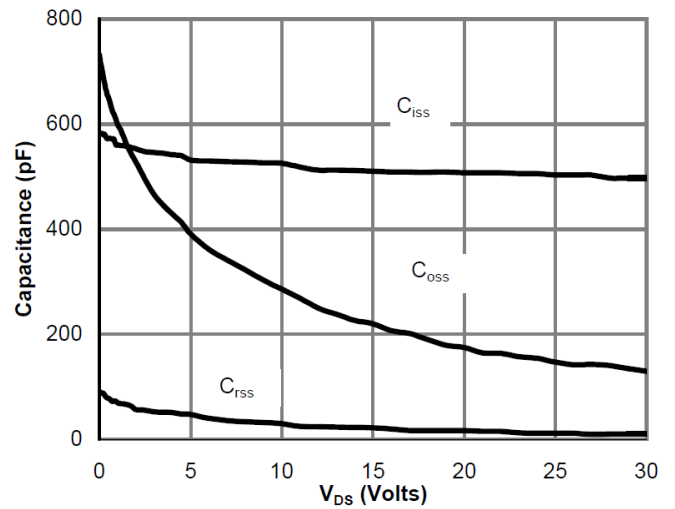

Figure 8: Capacitance Characteristics

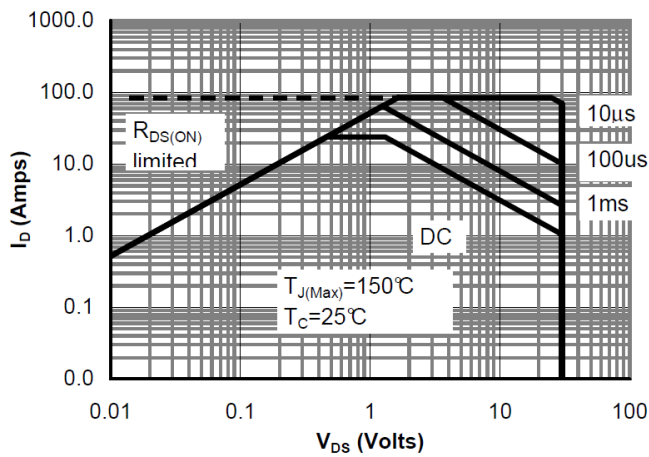

Figure 9: Maximum Forward Biased Safe Operating Area

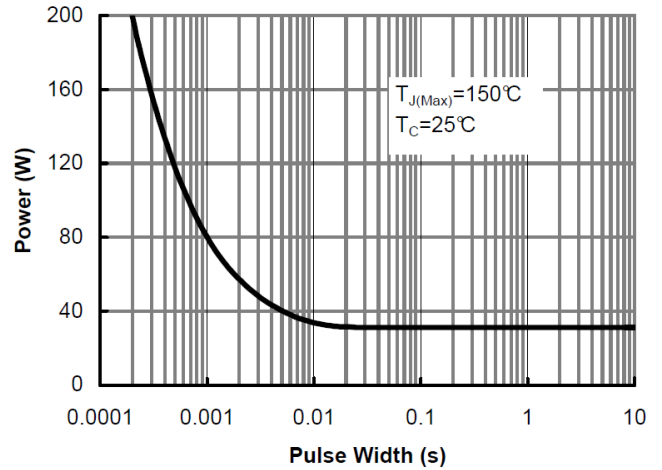

Figure 10: Single Pulse Power Rating Junction-to-Case

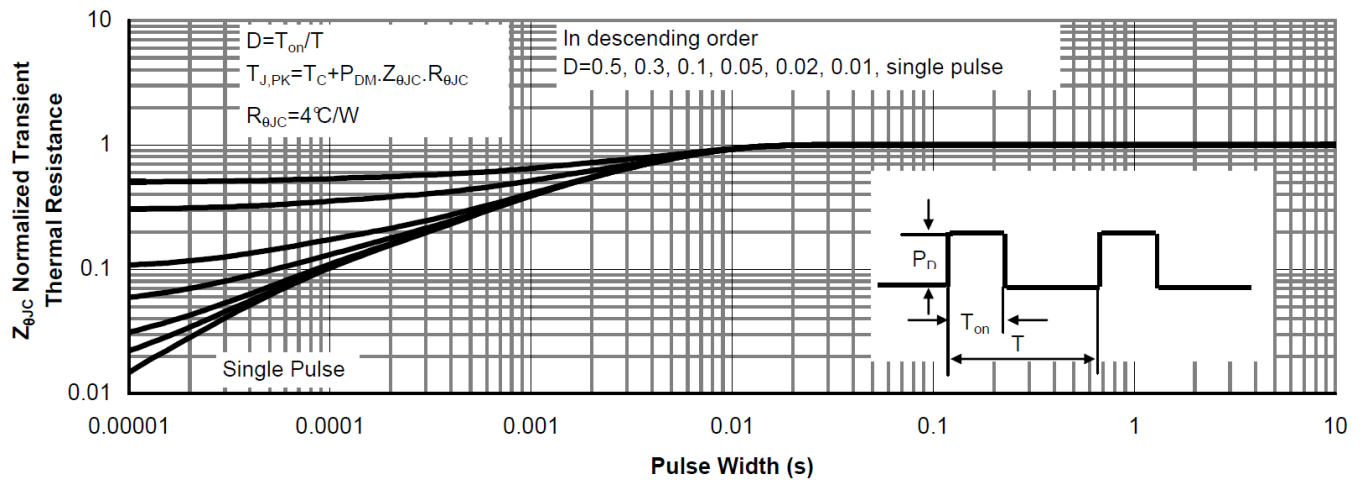
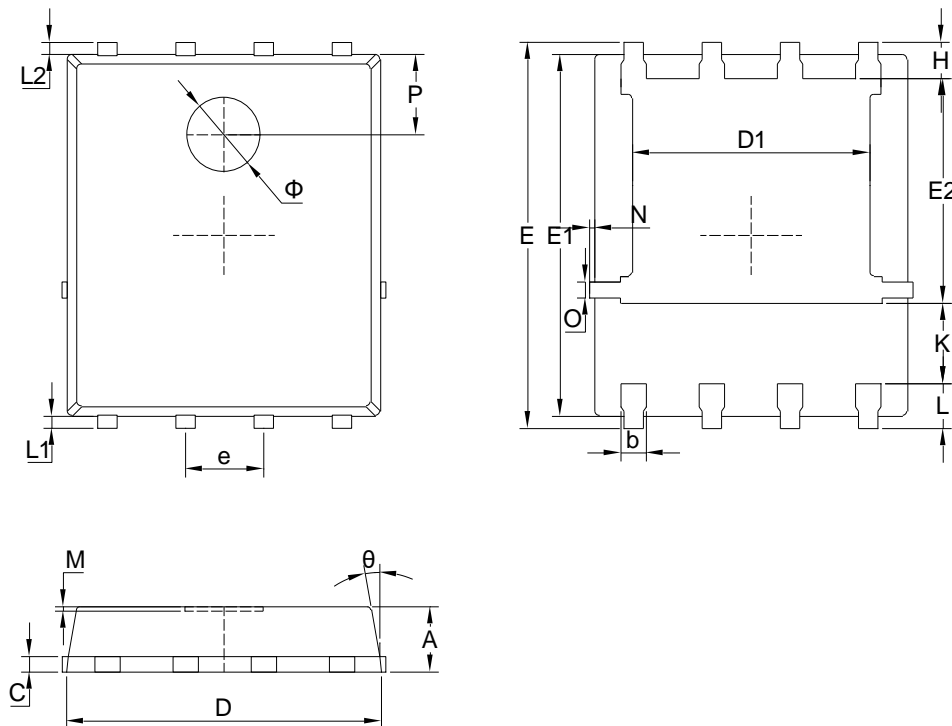

Figure 11: Normalized Maximum Transient Thermal Impedance

8. Dimension (PDFN5*6-8L)



Symbol	Dimensions in Millimeters			Symbol	Dimensions in Millimeters		
	MIN	NOM	MAX		MIN	NOM	MAX
A	0.90	1.05	1.20	H	0.48	0.58	0.68
b	0.35	0.40	0.50	K	1.17	1.27	1.37
C	0.20	0.25	0.35	L	0.64	0.74	0.84
D	4.90	5.05	5.20	L1/L2	0.20 REF.		
D1	3.72	3.82	3.92	θ	8°	10°	12°
E	6.00	6.15	6.30	M	0.08 REF.		
E1	5.60	5.75	5.90	N	0	-	0.15
E2	3.47	3.57	3.67	O	0.25 REF.		
e	1.27 BSC.			P	1.28 REF.		
Φ	1.20 REF						

DISCLAIMER

ELECSUPER PROVIDES TECHNICAL AND RELIABILITY DATA (INCLUDING DATASHEETS), DESIGN RESOURCES (INCLUDING REFERENCE DESIGNS), APPLICATION OR OTHER DESIGN ADVICE, SAFETY INFORMATION, AND OTHER RESOURCES "AS IS" AND WITH ALL FAULTS, AND DISCLAIMS ALL WARRANTIES, EXPRESS AND IMPLIED, INCLUDING WITHOUT LIMITATION ANY IMPLIED WARRANTIES OF MERCHANTABILITY, FITNESS FOR A PARTICULAR PURPOSE OR NON-INFRINGEMENT OF THIRD PARTY INTELLECTUAL PROPERTY RIGHTS.

These resources are intended for skilled developers designing with ElecSuper products. You are solely responsible for

- (1) selecting the appropriate ElecSuper products for your application;
- (2) designing, validating and testing your application;
- (3) ensuring your application meets applicable standards, and any other safety, security, or other requirements.

These resources are subject to change without notice. ElecSuper grants you permission to use these resources only for development of an application that uses the ElecSuper products described in the resource. Other reproduction and display of these resources are prohibited. No license is granted to any other ElecSuper intellectual property right or to any third party intellectual property right. ElecSuper disclaims responsibility for, and you will fully indemnify ElecSuper and its representatives against, any claims, damages, costs, losses, and liabilities arising out of your use of these resources. ElecSuper's products are provided subject to ElecSuper's Terms of Sale or other applicable terms available either on www.elecsuper.com or provided in conjunction with such ElecSuper products. ElecSuper's provision of these resources does not expand or otherwise alter ElecSuper's applicable warranties or warranty disclaimers for ElecSuper products.