

SuperMOS – SOT-23 60V V_{DSS} , $1.85\Omega R_{DS(on)}$, N-channel MOSFET

1. Description

The SRK7002LT1G-ES is N-Channel enhancement MOS Field Effect Transistor. Uses advanced technology and design to provide excellent $R_{DS(ON)}$ with low gate charge. Device is suitable for use in DC-DC conversion, power switch and charging circuit. Standard Product SRK7002LT1G-ES is Pb-free.

2. Features

- 60V, $R_{DS(ON)}=1.85\Omega(TYP.) @V_{GS}=10V$
- $R_{DS(ON)}=2.05\Omega(TYP.) @V_{GS}=4.5V$
- Use trench MOSFET technology
- High density cell design for low $R_{DS(on)}$
- ESD Protection - HBM : 2kV
- Material: Halogen free
- Reliable and rugged
- Avalanche Rated
- Low leakage current

3. Applications

- PWM applications
- Load switch
- Power management in portable/desktop PCs
- DC/DC conversion

4. Ordering Information

Part Number	Package	Marking	Material	Packing	Quantity per reel	Flammability Rating	Reel Size
SRK7002LT1G-ES	SOT-23	72K	Halogen free	Tape & Reel	3,000 PCS	UL 94V-0	7 inches

Table-1 Ordering information

5. Pin Configuration and Functions

Pin	Function	Outline	Circuit Diagram
1	Gate		
2	Source		
3	Drain		

Table-2 Pin configuration

6. Specification

Absolute Maximum Rating & Thermal Characteristics

Ratings at 25 °C ambient temperature unless otherwise specified.

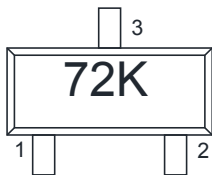
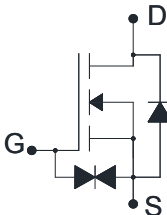
Parameter		Symbol	Limit	Unit
Drain-Source Voltage		BV_{DSS}	60	V
Gate-Source Voltage		V_{GS}	± 20	V
Continuous Drain Current	$T_A=25^\circ\text{C}$	I_D	0.3	A
	$T_A=100^\circ\text{C}$		0.2	
Maximum Power Dissipation		P_D	350	mW
Pulsed Drain Current		I_{DM}	1.2	A
Operating Junction Temperature		T_J	150	$^\circ\text{C}$
Lead Temperature		T_L	260	$^\circ\text{C}$
Storage Temperature Range		T_{stg}	-55 to 150	$^\circ\text{C}$

Thermal resistance ratings

Single Operation			
Parameter	Symbol	Typical	Unit
Junction-to-Ambient Thermal Resistance	$R_{\theta JA}$	357	$^\circ\text{C}/\text{W}$

Electrical Characteristics

At TA = 25°C unless otherwise specified

Parameter	Symbol	Test Conditions	Min.	Typ.	Max.	Unit
OFF CHARACTERISTICS						
Drain-to-Source Breakdown Voltage	BV_{DSS}	$V_{GS}=0V, I_D=250\mu A$	60			V
Zero Gate Voltage Drain Current	I_{DSS}	$V_{DS}=60V, V_{GS}=0V$			1.0	μA
Gate-to-source Leakage Current	I_{GSS}	$V_{DS}=0V, V_{GS}=\pm 20V$			± 10	μA
ON CHARACTERISTICS						
Gate Threshold Voltage	$V_{GS(TH)}$	$V_{GS}=V_{DS}, I_D=250\mu A$	1.0	1.6	2.0	V
Drain-to-source On-resistance	$R_{DS(on)}$	$V_{GS}=10V, I_D=0.3A$		1.85	2.2	Ω
		$V_{GS}=4.5V, I_D=0.2A$		2.05	3.0	
CHARGES, CAPACITANCES AND GATE RESISTANCE						
Input Capacitance	C_{ISS}	$V_{GS}=0V, f=1MHz, V_{DS}=25V$		28		pF
Output Capacitance	C_{OSS}			11		
Reverse Transfer Capacitance	C_{RSS}			4		
Total Gate Charge	$Q_{G(TOT)}$	$V_{GS}=4.5V, V_{DS}=10V, I_D=0.3A$		1.8		nC
Gate-to-Source Charge	Q_{GS}			0.3		
Gate-to-Drain Charge	Q_{GD}			0.6		
SWITCHING CHARACTERISTICS						
Turn-On Delay Time	$t_{d(ON)}$	$V_{GS}=10V, V_{DS}=10V, I_D=0.2A, R_G=10\Omega$		2		ns
Rise Time	t_r			15		
Turn-Off Delay Time	$t_{d(OFF)}$			7		
Fall Time	t_f			20		
BODY DIODE CHARACTERISTICS						
Forward Voltage	V_{SD}	$V_{GS}=0V, I_S=0.3A$			1.5	V

7. Typical Characteristic

Figure 1: Output Characteristics

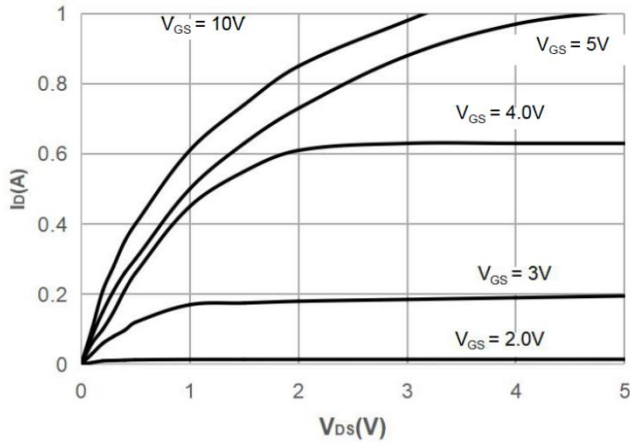

Figure 2: Typical Transfer Characteristics

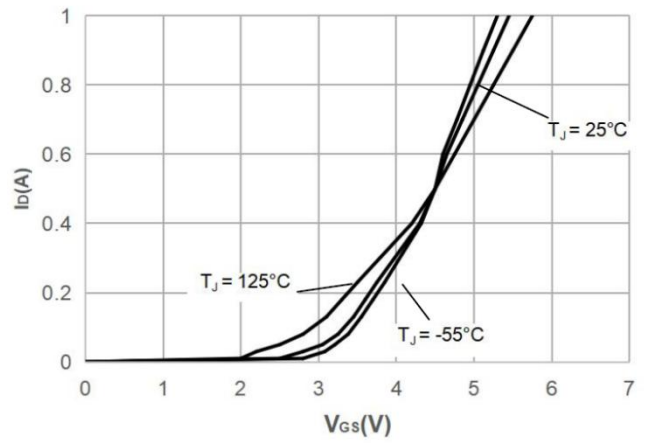

Figure 3: On-resistance vs. Drain Current

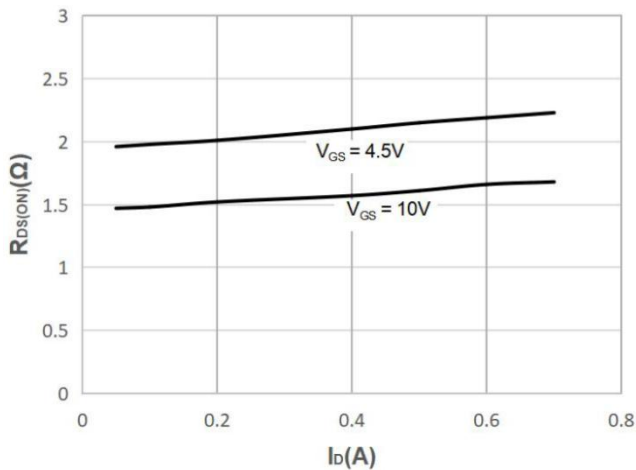

Figure 4: Body Diode Characteristics

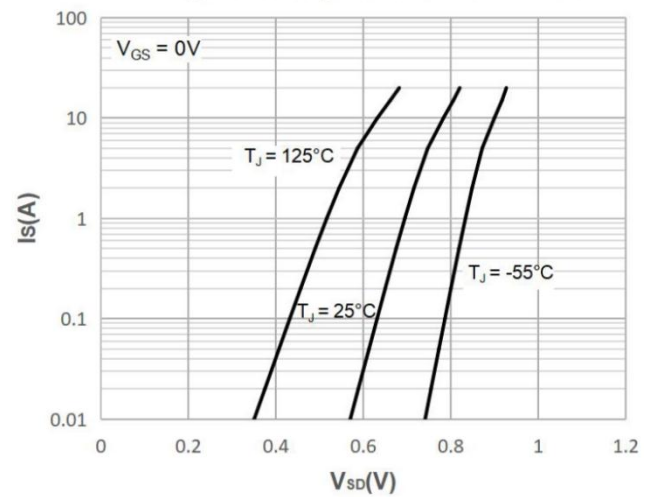

Figure 5: Gate Charge Characteristics

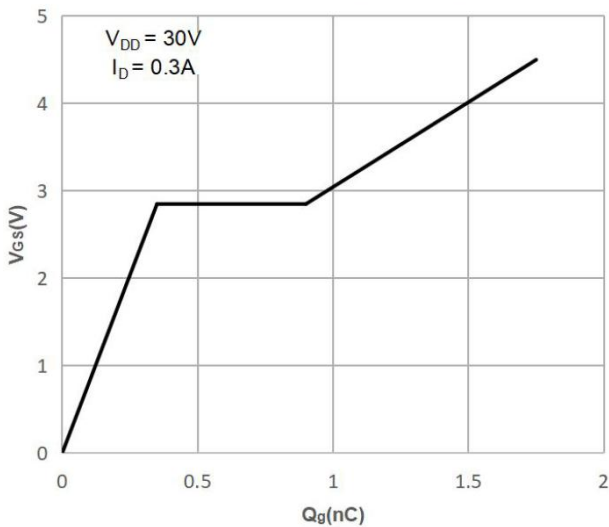

Figure 6: Capacitance Characteristics

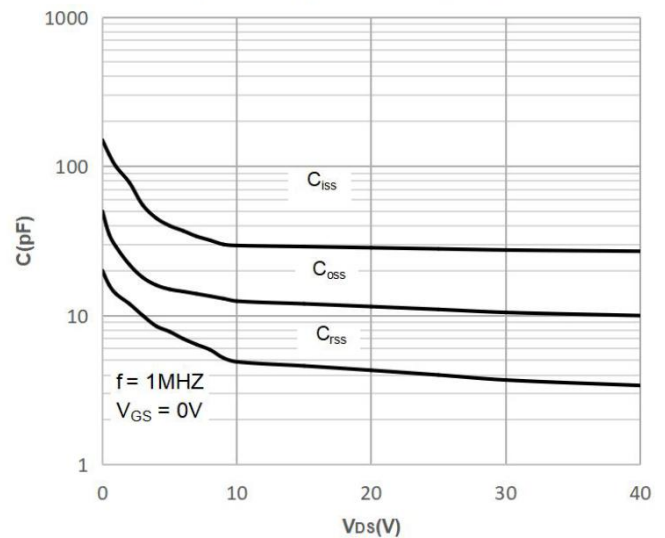

Figure 7: Normalized Breakdown voltage vs. Junction Temperature

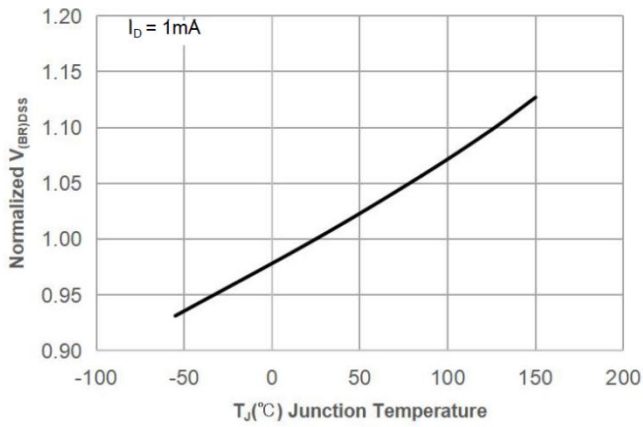

Figure 8: Normalized on Resistance vs. Junction Temperature

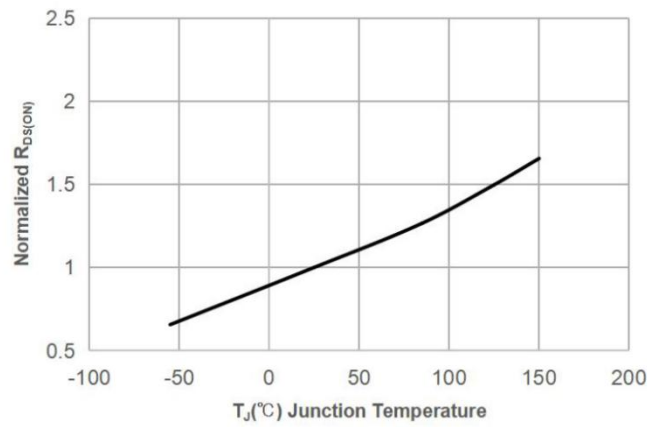

Figure 9: Maximum Safe Operating Area

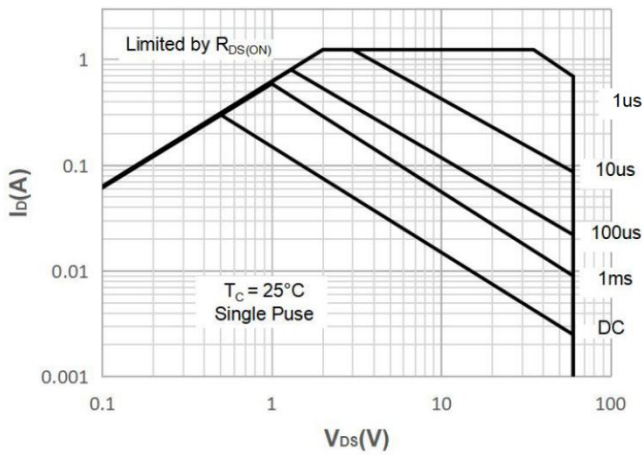

Figure 10: Maximum Continuous Drianc Current vs. Case Temperature

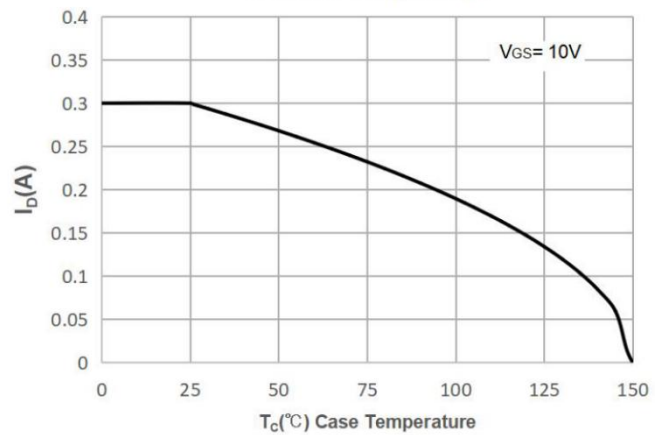

Figure 11: Normalized Maximum Transient Thermal Impedance

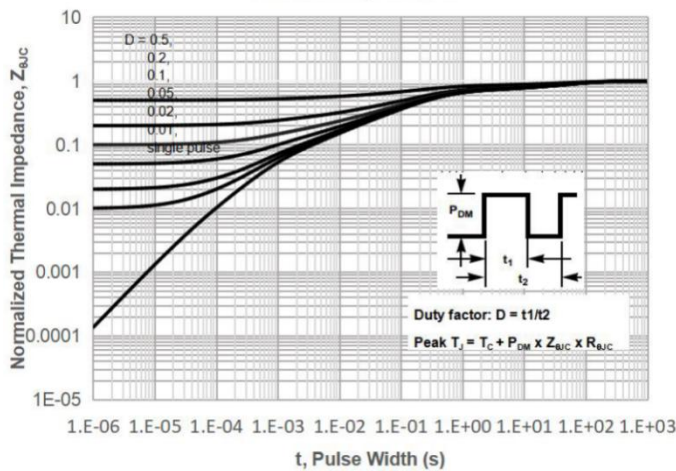
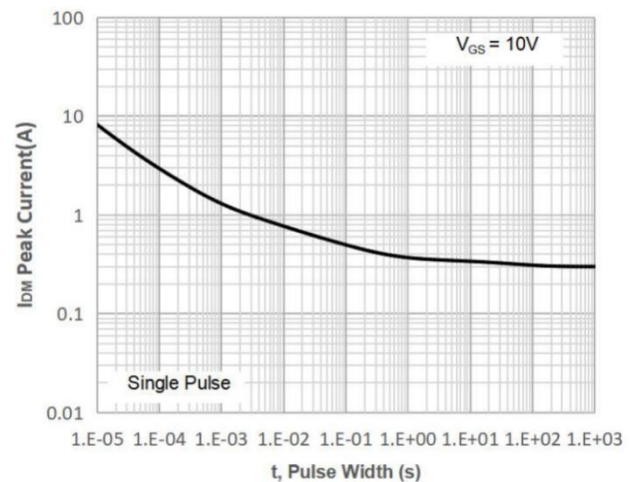
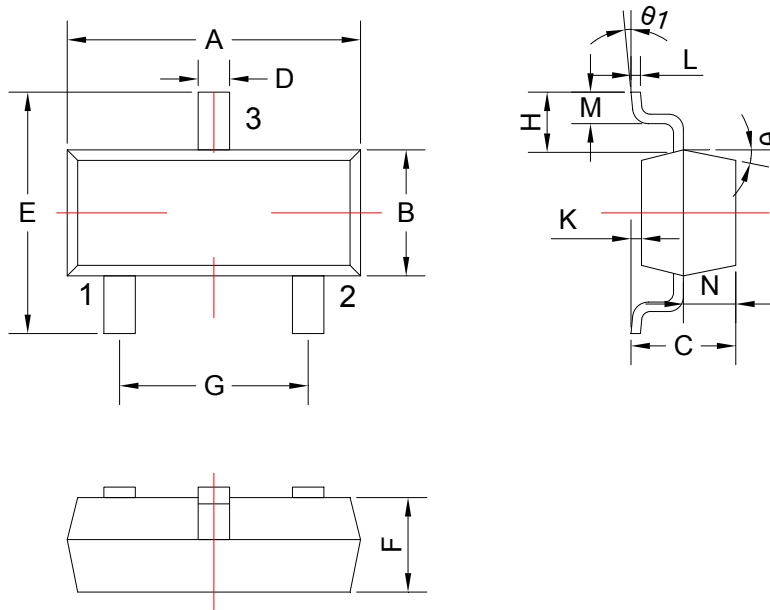

Figure 12: Peak Current Capacity



8. Dimension (SOT-23)



COMMON DIMENSIONS CUNITS MEASURE=MILLIMETER					
SYMBOL	MIN	MAX	SYMBOL	MIN	MAX
A	2.85	3.04	M	0.20	-
B	1.20	1.40	N	0.50	0.70
C	0.90	1.10	θ	5°	9°
D	0.40	0.50	F	0.95	1.05
E	2.25	2.55	H	0.50	0.60
G	1.80	2.00	L	0.095	0.115
K	0	0.10	θ_1	0°	8°

DISCLAIMER

ELECSUPER PROVIDES TECHNICAL AND RELIABILITY DATA (INCLUDING DATASHEETS), DESIGN RESOURCES (INCLUDING REFERENCE DESIGNS), APPLICATION OR OTHER DESIGN ADVICE, SAFETY INFORMATION, AND OTHER RESOURCES "AS IS" AND WITH ALL FAULTS, AND DISCLAIMS ALL WARRANTIES, EXPRESS AND IMPLIED, INCLUDING WITHOUT LIMITATION ANY IMPLIED WARRANTIES OF MERCHANTABILITY, FITNESS FOR A PARTICULAR PURPOSE OR NON-INFRINGEMENT OF THIRD PARTY INTELLECTUAL PROPERTY RIGHTS.

These resources are intended for skilled developers designing with ElecSuper products. You are solely responsible for

- (1) selecting the appropriate ElecSuper products for your application;
- (2) designing, validating and testing your application;
- (3) ensuring your application meets applicable standards, and any other safety, security, or other requirements.

These resources are subject to change without notice. ElecSuper grants you permission to use these resources only for development of an application that uses the ElecSuper products described in the resource. Other reproduction and display of these resources are prohibited. No license is granted to any other ElecSuper intellectual property right or to any third party intellectual property right. ElecSuper disclaims responsibility for, and you will fully indemnify ElecSuper and its representatives against, any claims, damages, costs, losses, and liabilities arising out of your use of these resources. ElecSuper's products are provided subject to ElecSuper's Terms of Sale or other applicable terms available either on www.elecsuper.com or provided in conjunction with such ElecSuper products. ElecSuper's provision of these resources does not expand or otherwise alter ElecSuper's applicable warranties or warranty disclaimers for ElecSuper products.