

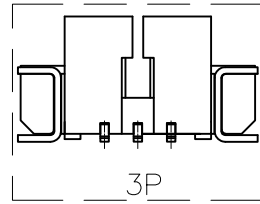

This Print is Preliminary  
Unconfirm Product  
Conatct Product Engineering  
Befor Use This Drawing

REV.	ECN NO.	DESCRIPTION	DWN.	APVD.	DATE
BX1	N/A	图面变更	YSL	CJH	2022.03.04
BX2	N/A	图面变更	YSL	CJH	2022.04.20

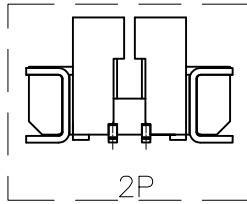
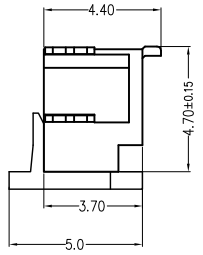
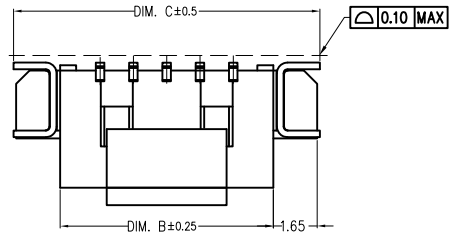

**Specifications:**  
 Contact resistance:  $\leq 20m\Omega$   
 Insulation resistance:  $\geq 100M\Omega$   
 Rated voltage: 125V AC DC  
 Rated current: 1.0A AC DC  
 Withstand voltage: 500V AC/minute  
 Temperature range:  $-25^{\circ}C \sim +105^{\circ}C$   
 Housing: LCP UL94V-0, Natural  
 CAP: LCP UL94V-0, Natural  
 Contacts: Phosphor bronze/Sn  
 Solder tabs: Brass/Sn

ORDER INFORMATION:

WF\*\*H66WJA268

PIN NO.(SEE TABLE)  
 02  
 03  
 .  
 .  
 16

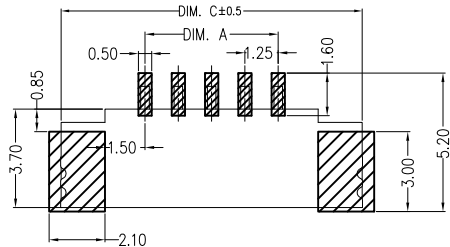
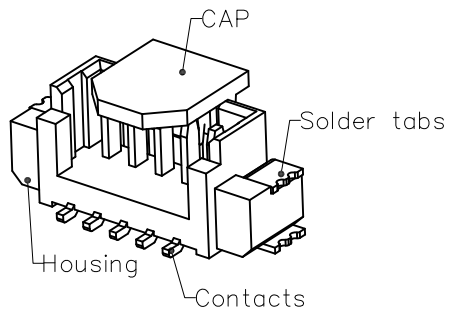
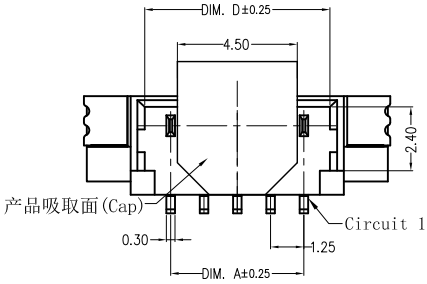

SUGGESTED PCB LAYOUT

Circuit	Dimensions (mm)			
	DIM. A	DIM. B	DIM. C	DIM. D
02	1.25	4.25	7.75	3.20
03	2.50	5.50	9.00	4.45
04	3.75	6.75	10.25	5.70
05	5.00	8.00	11.50	6.95
06	6.25	9.25	12.75	8.20
07	7.50	10.50	14.00	9.45
08	8.75	11.75	15.25	10.70
09	10.00	13.00	16.50	11.95
10	11.25	14.25	17.75	13.20
11	12.50	15.50	19.00	14.45
12	13.75	16.75	20.25	15.70
13	15.00	18.00	21.50	16.95
14	16.25	19.25	22.75	18.20
15	17.50	20.50	24.00	19.45
16	18.75	21.75	25.25	20.70

THE RESTRICTION OF ENVIRONMENTAL MANAGEMENT SUBSTANCES IS BASED ON THE NEW VERSION OF HTQ-S-3Q-83

TITLE: 1.25Pitch WAFER. V/A STM TYPE		HOMETOM www.hometom.com.tw HORNG TONG ENTERPRISE CO.,LTD.	
TOLERANCE		APPROVAL:	UNIT: mm
LINEAR:	ANGLE:	CHECK:	PART NO: WF**H66WJA268
X. $\pm 0.50$	X°. $\pm 5^{\circ}$		SIZE: A4
.X $\pm 0.30$	.X° $\pm 2^{\circ}$		DWG.NO: CWF228-00
.XX $\pm 0.20$	.XX° $\pm 1^{\circ}$	DRAWN:	SCALE: 1:1
CUSTOMER DRAWING	REV: BX2	PRJ.:	SHEET: 1 / 2



REV.	ECN NO.	DESCRIPTION	DWN.	APVD.	DATE
BX1	N/A	图面变更	YSL	CJH	2022.03.04
BX2	N/A	图面变更	YSL	CJH	2022.04.20

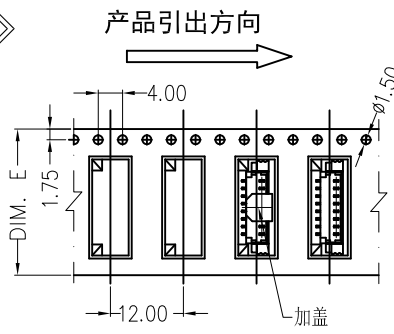

02~09 CONTACTS

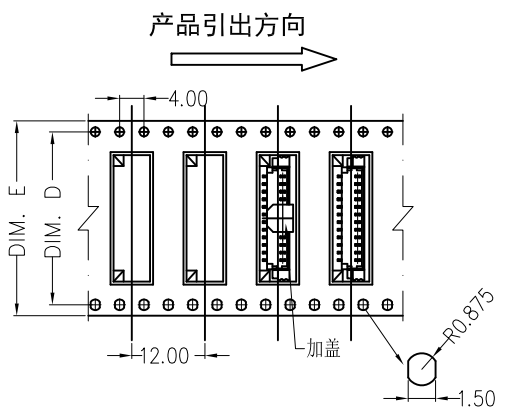

10~16 CONTACTS

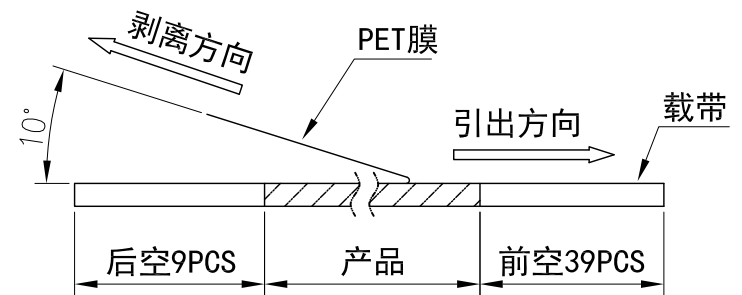

(PET膜剥离示意图)

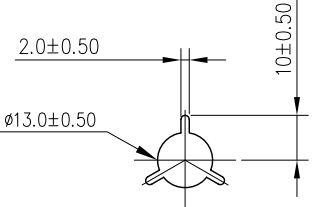
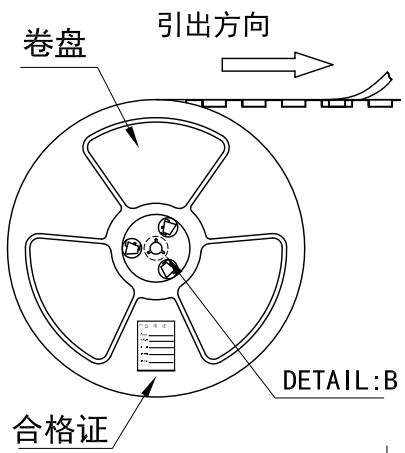

DETAIL: B

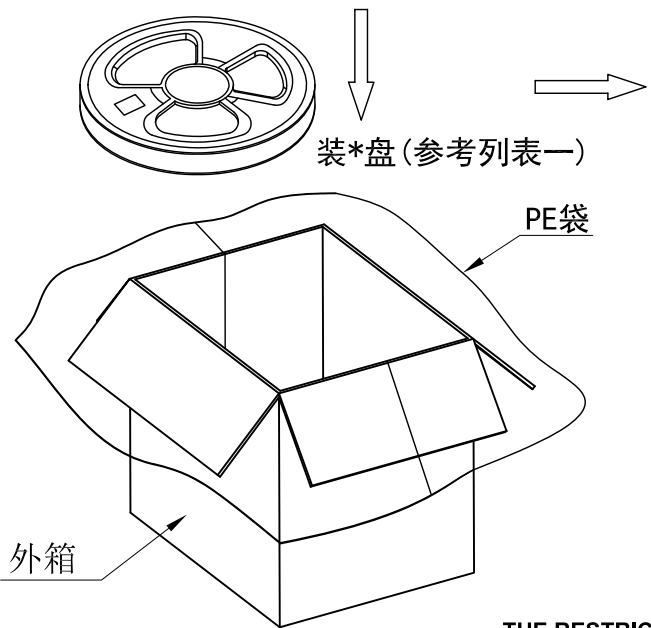

装\*盘(参考列表一)

外箱

列表一

Circuits	DIM. D	DIM. E	Q'ty/Reel	Packing (Reel/Caton)
02-03PIN	-	16	1000PCS	20/Reel
04-09PIN	-	24	1000PCS	15/Reel
10-13PIN	28.4	32	1000PCS	11/Reel
14-16PIN	40.4	44	1000PCS	8/Reel

包装说明:

- 把成品包入卷盘中，每盘装1000PCS，卷盘上贴上合格证，将装好产品的卷盘放进外箱中，外箱内先套一个大PE袋，外箱上贴贴上合格证。
- 所有材料有害物控制需符合RoHS标准。

THE RESTRICTION OF ENVIRONMENTAL MANAGEMENT SUBSTANCES IS BASED ON THE NEW VERSION OF HTQ-S-3Q-83

TITLE: 1.25Pitch WAFER. V/A STM TYPE		HOMETOM www.hometom.com.tw HORNG TONG ENTERPRISE CO.,LTD.	
TOLERANCE		APPROVAL:	UNIT: mm
LINEAR: X. ±0.50 .X ±0.20 XX ±0.20	ANGLE: X° ±5° .X° ±2° .XX° ±1°	CHECK:	PART NO: WF**H66WJA268
CUSTOMER DRAWING	REV: BX2	DRAWN:	SIZE: A4 DWG.NO: CWF228-00
SCALE: 1:1		PRJ.:	SHEET: 2 / 2