

MSKSEMI 美森科

SEMICONDUCTOR



ESD



TVS



TSS



MOV



GDT



PLED

PESDALC10N5VU-MS

Product specification



Features

- IEC 61000-4-2 Level 4 ESD Protection
 - ±12kV Contact Discharge
 - ±17kV Air Discharge
- IEC 61000-4-4 EFT Protection
 - 40A (5/50ns)
- IEC 61000-4-5 Surge
 - 4.5A (8/20us)
- RoHS compliance
- Protecting four I/O line
- Ultra-low Capacitance:0.6pF (Typical)
- Low clamping voltage
- Low leakage current
- Solid-state silicon technology

Applications

- HDMI/USB2.0
- Monitors and flat panel displays
- 10/100/1000 ethernet
- Notebook computers
- SIM ports
- ATM interface

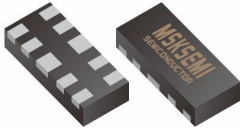
Pin Configuration and Functions

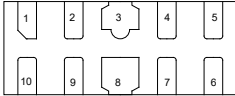
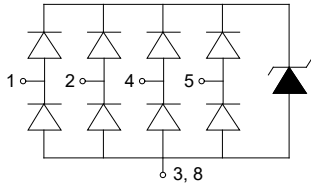
PACKAGE OUTLINE	Outline	Circuit Diagram
	 	
SLP2510P8		

Pin	Name	Description
1	IO	Connect to IO
2	IO	Connect to IO
3	GND	Connect to GND
4	IO	Connect to IO
5	IO	Connect to IO
6	NC	NO Connection
7	NC	NO Connection
8	GND	Connect to GND
9	NC	NO Connection
10	NC	NO Connection

Absolute Maximum rating

Over operating free-air temperature range otherwise

Parameters	Symbol	Min.	Max.	Unit
Peak pulse power (tp=8/20us)@25°C	P _{pk}	-	70	W
Peak pulse current (tp=8/20us)@25°C	I _{PP}		4.5	A
ESD (IEC61000-4-2 air discharge) @25°C	V _{ESD}	-	±17	kV
ESD (IEC61000-4-2 contact discharge) @25°C	V _{ESD}	-	±12	kV
Junction temperature	T _J	-	150	°C
Operating temperature	T _{OP}	-40	125	°C
Storage temperature	T _{STG}	-55	150	°C
Lead temperature	T _L	-	260	°C

Electrical Characteristics At TA = 25°C unless otherwise noted

Parameters	Symbol	conditions	Min.	Typ.	Max.	Unit
Reverse stand-off voltage	V _{RWM}				5.0	V
Reverse Breakdown Voltage	V _{BR}	I _r = 1mA	6.0			V
Reverse Leakage Current	I _r	V _{RWM} =5V			1.0	uA
Peak Pulse Current	I _{PP}	TP=8/20us@25°C			4.5	A
Clamping Voltage	V _{CL}	I _{PP} =1A; TP=8/20us		9.0	11.0	V
Clamping Voltage	V _{CL}	I _{PP} =4.5A; TP=8/20us		12.0	15.0	V
Junction capacitance	C _J	I/O pins to ground; V _R =0V; f = 1MHz		0.6		pF
		Between I/O pins; V _R =0V; f = 1MHz		0.3		

Typical Characteristic

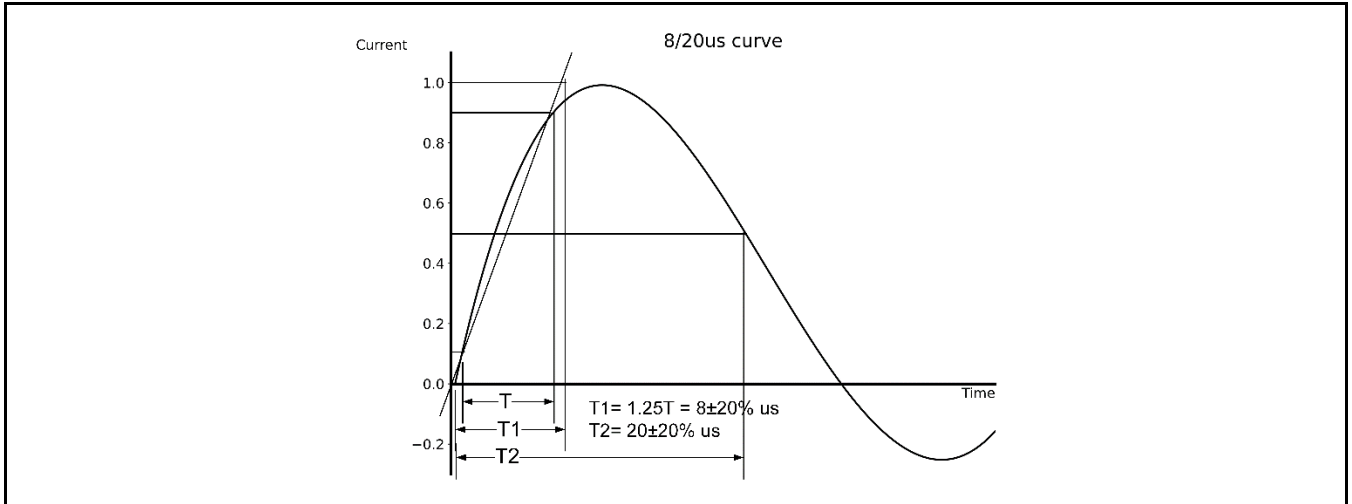

Typical Application

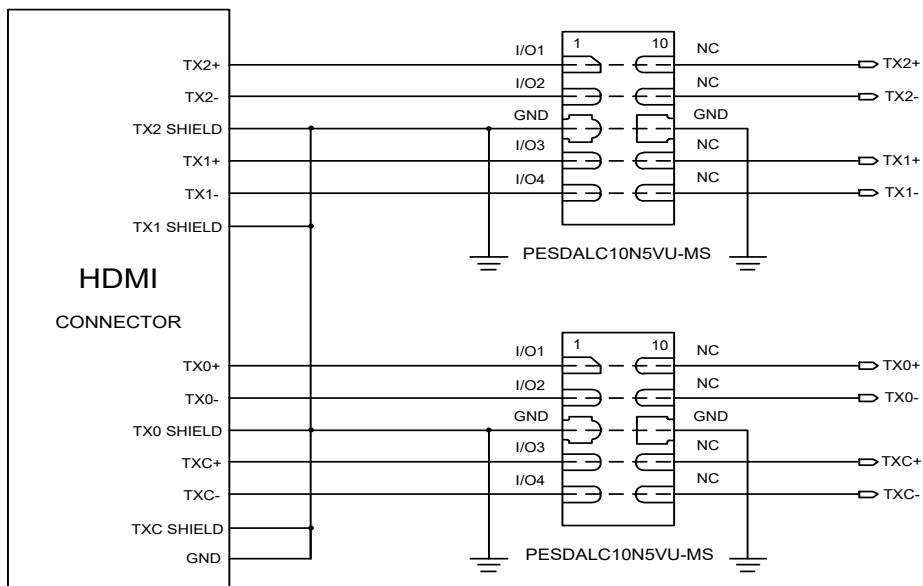

Typical HDMI Interface Application

Dimension (DFN2510)

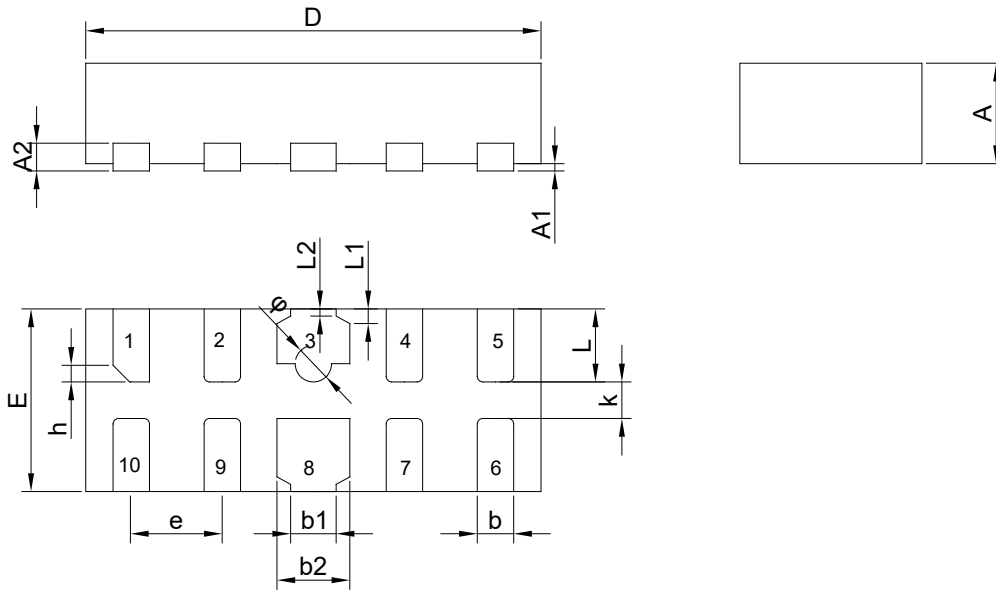

Dimensions in Millimeter							
Symbol	Min.	Nom.	Max.	Symbol	Min.	Nom.	Max.
A	0.500	0.550	0.600	D	2.450	2.500	2.550
A1	0.00	/	0.05	E	0.950	1.00	1.050
A2	0.122	0.152	0.200	e	0.450	0.500	0.550
b	0.150	0.200	0.250	h	0.080	0.120	0.150
b1	0.200	0.250	0.300	k	0.150	0.200	0.250
b2	0.350	0.400	0.450	L	0.350	0.400	0.450
L1	0.075 REF			L2	0.05 REF		
φ	0.150	0.200	0.250				

REEL SPECIFICATION

P/N	PKG	QTY
PESDALC10N5VU-MS	DFN2510	3000

Attention

- Any and all MSKSEMI Semiconductor products described or contained herein do not have specifications that can handle applications that require extremely high levels of reliability, such as life-support systems, aircraft's control systems, or other applications whose failure can be reasonably expected to result in serious physical and/or material damage. Consult with your MSKSEMI Semiconductor representative nearest you before using any MSKSEMI Semiconductor products described or contained herein in such applications.
- MSKSEMI Semiconductor assumes no responsibility for equipment failures that result from using products at values that exceed, even momentarily, rated values (such as maximum ratings, operating condition ranges, or other parameters) listed in products specifications of any and all MSKSEMI Semiconductor products described or contained herein.
- Specifications of any and all MSKSEMI Semiconductor products described or contained herein stipulate the performance, characteristics, and functions of the described products in the independent state, and are not guarantees of the performance, characteristics, and functions of the described products as mounted in the customer's products or equipment. To verify symptoms and states that cannot be evaluated in an independent device, the customer should always evaluate and test devices mounted in the customer's products or equipment.
- MSKSEMI Semiconductor strives to supply high-quality high-reliability products. However, any and all semiconductor products fail with some probability. It is possible that these probabilistic failures could give rise to accidents or events that could endanger human lives, that could give rise to smoke or fire, or that could cause damage to other property. When designing equipment, adopt safety measures so that these kinds of accidents or events cannot occur. Such measures include but are not limited to protective circuits and error prevention circuits for safe design, redundant design, and structural design.
- In the event that any or all MSKSEMI Semiconductor products (including technical data, services) described or contained herein are controlled under any of applicable local export control laws and regulations, such products must not be exported without obtaining the export license from the authorities concerned in accordance with the above law.
- No part of this publication may be reproduced or transmitted in any form or by any means, electronic or mechanical, including photocopying and recording, or any information storage or retrieval system, or otherwise, without the prior written permission of MSKSEMI Semiconductor.
- Information (including circuit diagrams and circuit parameters) herein is for example only ; it is not guaranteed for volume production. MSKSEMI Semiconductor believes information herein is accurate and reliable, but no guarantees are made or implied regarding its use or any infringements of intellectual property rights or other rights of third parties.
- Any and all information described or contained herein are subject to change without notice due to product/technology improvement, etc. When designing equipment, refer to the "Delivery Specification" for the MSKSEMI Semiconductor product that you intend to use.