

<b>Features</b> <ul style="list-style-type: none"> <li>➤ Split Gate Trench MOSFET technology</li> <li>➤ Excellent package for heat dissipation</li> <li>➤ High density cell design for low <math>R_{DS(ON)}</math></li> </ul>	<b><i>Bvdss</i></b>	<b><i>Rdson</i></b>	<b><i>ID</i></b>
	<b>-60V</b>	<b>5.4mΩ</b>	<b>-110A</b>
<b>Application</b> <ul style="list-style-type: none"> <li>➤ DC-DC Converters</li> <li>➤ Synchronous-rectification applications</li> <li>➤ Power management functions</li> </ul>			
<b>Package</b> <div style="display: flex; justify-content: space-around; align-items: flex-end;"> <div style="text-align: center;">             Marking and pin assignment         </div> <div style="text-align: center;">             TO-263 top view         </div> <div style="text-align: center;">             Schematic diagram         </div> </div>			

**Package Marking and Ordering Information**

Device Marking	Device	Device Package	Quantity
110P06	S110P06G	TO-263	800

**Absolute Maximum Ratings** ( $T_J=25^{\circ}\text{C}$  unless otherwise specified)

Parameter	Symbol	Value	Unit	
Drain-Source Voltage	$V_{DS}$	-60	V	
Gate-Source Voltage	$V_{GS}$	$\pm 20$	V	
Continuous Drain Current	$T_C=25^{\circ}\text{C}$	$I_D$	-110	A
	$T_C=100^{\circ}\text{C}$	$I_D$	-70	A
Pulsed Drain Current	$I_{DM}^1$	-440	A	
Single Pulse Avalanche Energy	$E_{AS}^2$	960	mJ	
Power Dissipation	$T_C = 25^{\circ}\text{C}$	$P_D$	180	W
Operating junction and storage temperature	$T_J, T_{STG}$	150, -55 ~ 150	$^{\circ}\text{C}$	
Maximum Temperature for Soldering	$T_L$	260	$^{\circ}\text{C}$	



## Thermal Resistance Ratings

Parameter	Symbol	Value	Unit
Thermal Resistance Junction-Case	$R_{\theta JC}$	0.69	$^{\circ}C/W$
Thermal Resistance, Junction -to-Ambient	$R_{\theta JA}$	60	$^{\circ}C/W$

## Ordering Information

Ordering Number	Package	Pin Assignment			Packing
Halogen Free		G	D	S	
HLS110P06G	TO-263	1	2	3	Tape Reel

Electrical Characteristics ( $T_j=25^{\circ}C$  unless otherwise noted)

Parameter	Symbol	Test Conditions	Min.	Typ.	Max.	Unit
Drain-Source Breakdown Voltage	$V_{(BR)DSS}$	$V_{GS} = 0V, I_D = -250\mu A$	-60	-	-	V
Gate-body Leakage current	$I_{GSS}$	$V_{GS} = \pm 20V$	-	-	$\pm 100$	nA
Zero Gate Voltage Drain Current	$I_{DSS}$	$V_{DS} = -60V, V_{GS} = 0V$	-	-	1	$\mu A$
Gate-Threshold Voltage	$V_{GS(th)}$	$V_{DS} = V_{GS}, I_D = -250\mu A$	-1.6	-2.0	-2.4	V
Drain-Source On-Resistance	$R_{DS(on)}$	$V_{GS} = -10V, I_D = -15A$	-	5.4	7.0	m $\Omega$
Input Capacitance	$C_{ISS}$	$V_{DS} = -30V, V_{GS} = 0V,$ $f = 1MHz$	-	5403	-	pF
Output Capacitance	$C_{OSS}$		-	941	-	
Reverse Transfer Capacitance	$C_{RSS}$		-	48	-	
Gate Resistance	$R_g$	$V_{GS} = 0V, V_{DS}$ Open	-	2	-	$\Omega$
Total Gate Charge	$Q_g$	$V_{GS} = -10V, V_{DS} = -30V, I_D = -15A$	-	80.2	-	nC
Gate-Source Charge	$Q_{gs}$		-	15.2	-	
Gate-Drain Charge	$Q_{gd}$		-	11	-	
Turn-On Delay Time	$T_{d(on)}$	$V_{GS} = -10V, V_{DS} = -30V,$ $R_G = 3\Omega, I_D = -15A$ $R_L = 0.75\Omega$	-	4.5	-	ns
Rise Time	$T_R$		-	2.5	-	
Turn-Off Delay Time	$T_{d(off)}$		-	14.5	-	
Fall Time	$T_F$		-	3.5	-	
Diode Forward Current	$I_S$	$T_C = 25^{\circ}C$	-	-	-110	A
Diode Forward Voltage	$V_{SD}$	$I_S = -15A, V_{GS} = 0V$	-	-	-1.2	V
Reverse Recovery time	$T_{rr}$	$I_S = -15A, V_{DD} = -30V$ $di/dt = 100A/\mu s$	-	60	-	ns
Reverse Recovery Charge	$Q_{rr}$		-	105	-	nC



Note :

1.Repetitive rating; pulse width limited by maximum junction temperature

2.V<sub>DD</sub> =30V, L=0.3mH, R<sub>G</sub> =25Ω, Starting T<sub>J</sub>=25°C

### Typical Performance Characteristics

Fig1:Typ. output characteristics

$I_D = f(-V_{DS})$

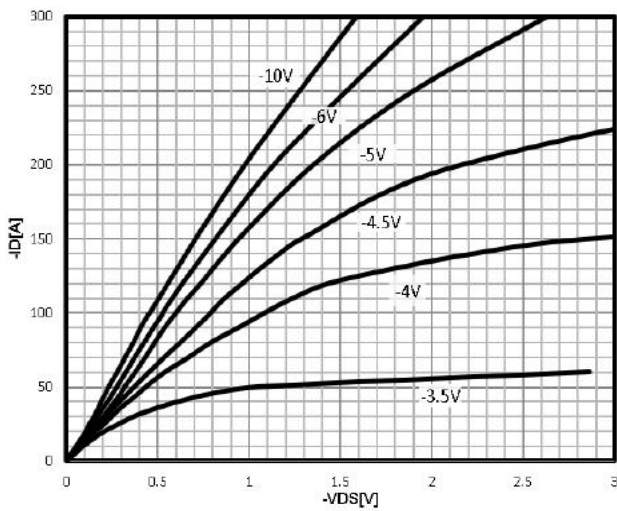

Fig2:Typ. drain-source on resistance

$R_{DS(on)} = f(-I_D)$

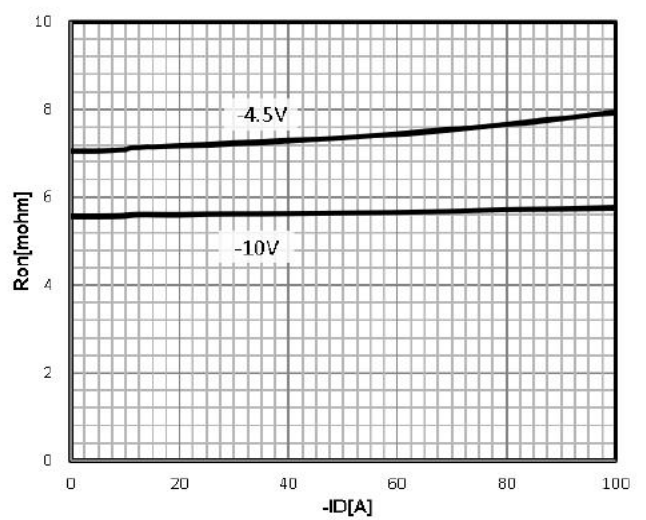

Fig3:

Typ. transfer characteristics

$-I_D = f(-V_{GS})$

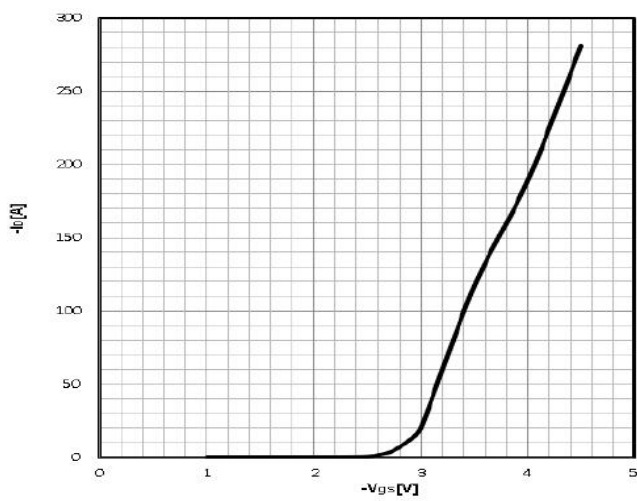

Fig4:Drain-source on-state resistance

$R_{DS(on)} = f(T_J); I_D = -15A; V_{GS} = -10V$

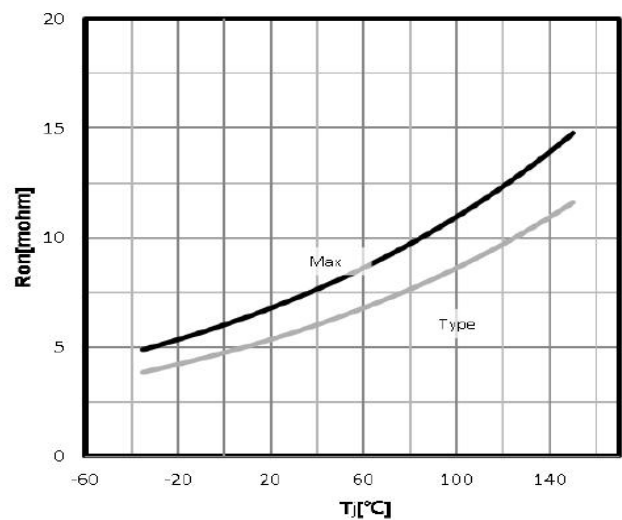



Fig5:Gate Threshold Voltage

$-V_{TH}=f(T_j); I_D=-250\mu A$

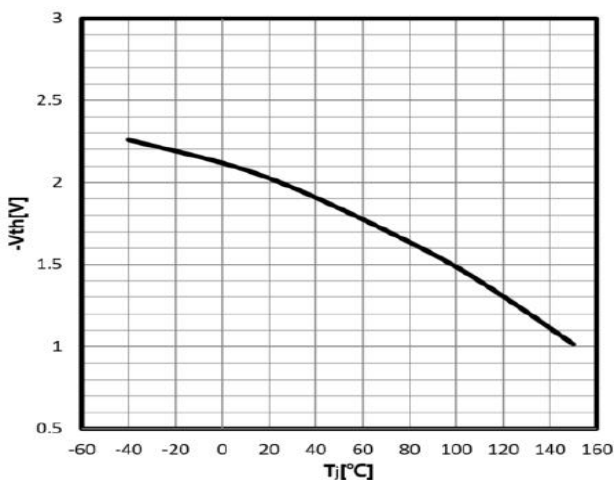

Fig6:Drain-source breakdown voltage

$V_{BR}(DSS)=f(T_j); I_D=-250\mu A$

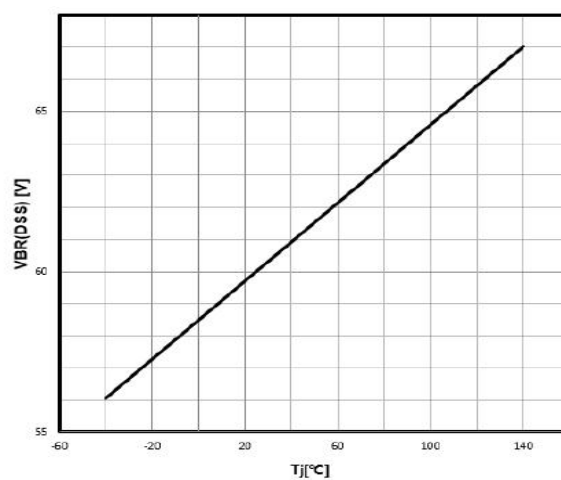

Fig7:Typ. gate charge

$V_{GS}=f(Q_g), I_D=-15A;$

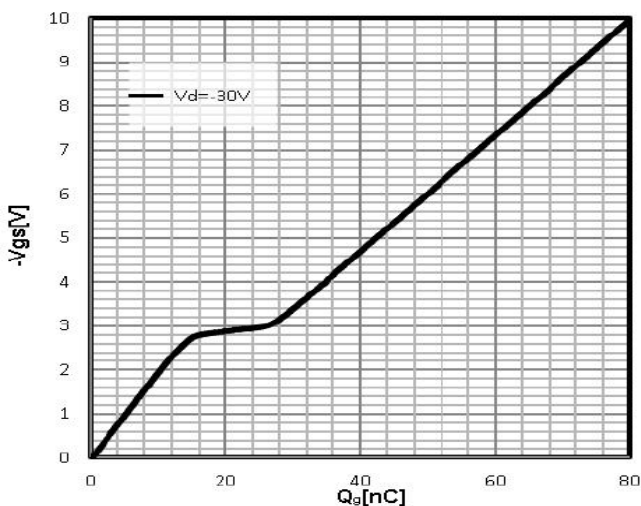

Fig8:Typ. capacitances

$C=f(V_{DS}); V_{GS}=0V; f=1MHz$

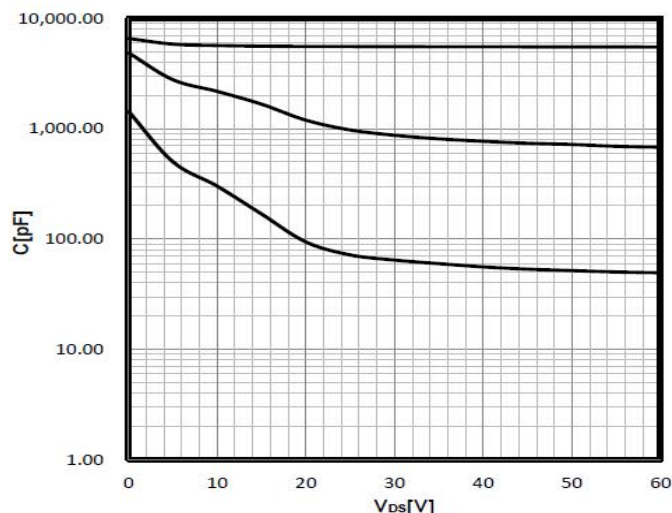

Fig9:Power Dissipation

$P_{tot}=f(T_c)$

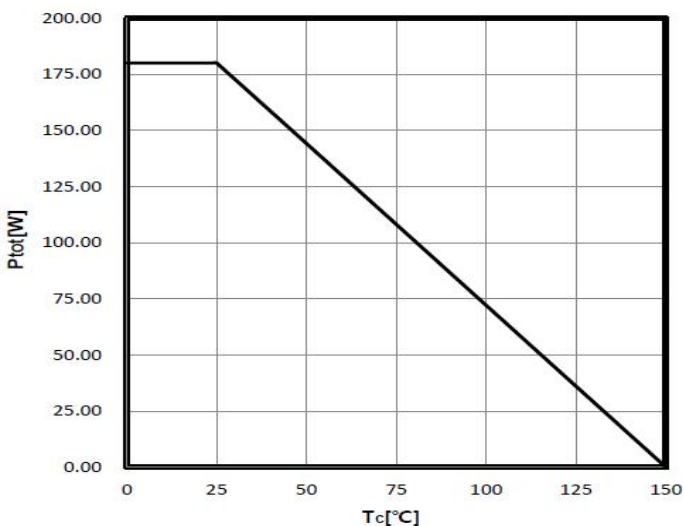

Fig10:Maximum Drain Current

$-I_D=f(T_c)$

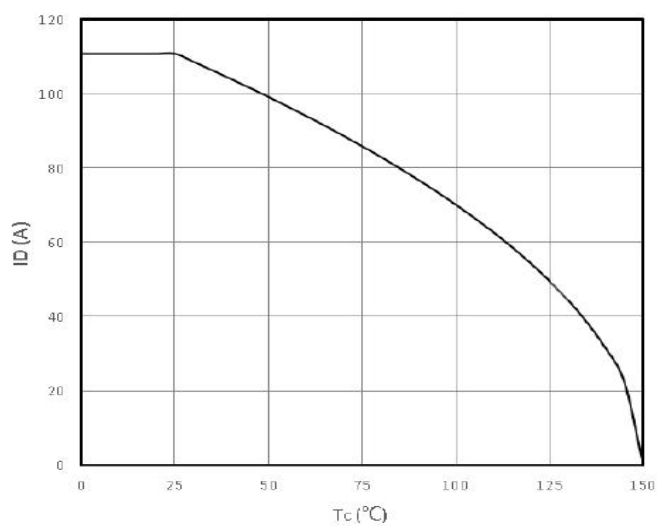

Fig11:Safe operating area

$$I_D = f(V_{DS})$$

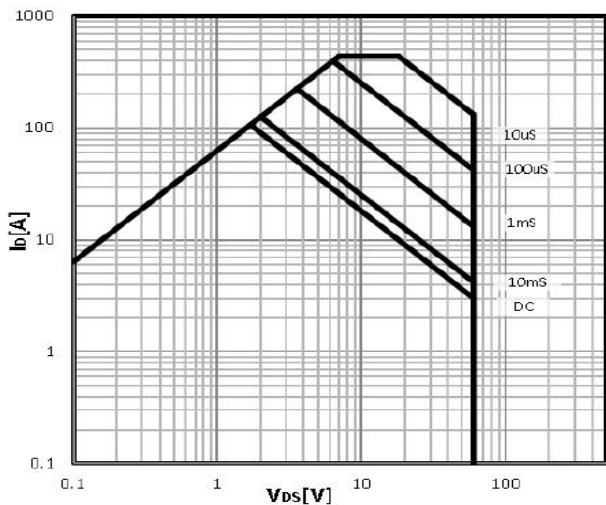

Fig12:Body Diode Forward Voltage Variation

$$-I_F = f(-V_{DS})$$

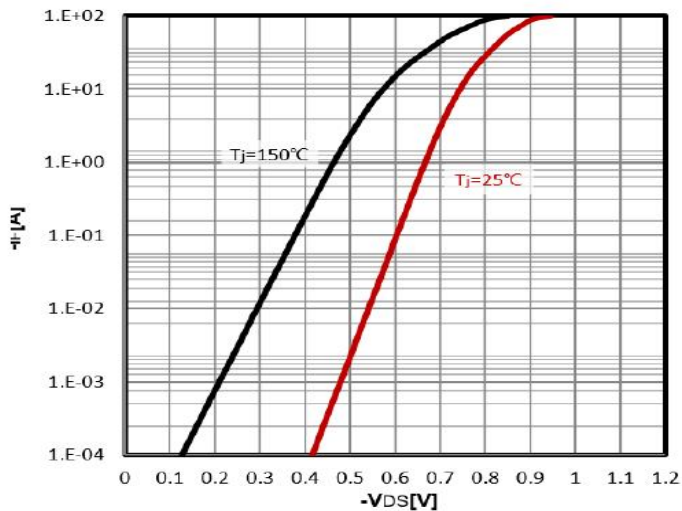
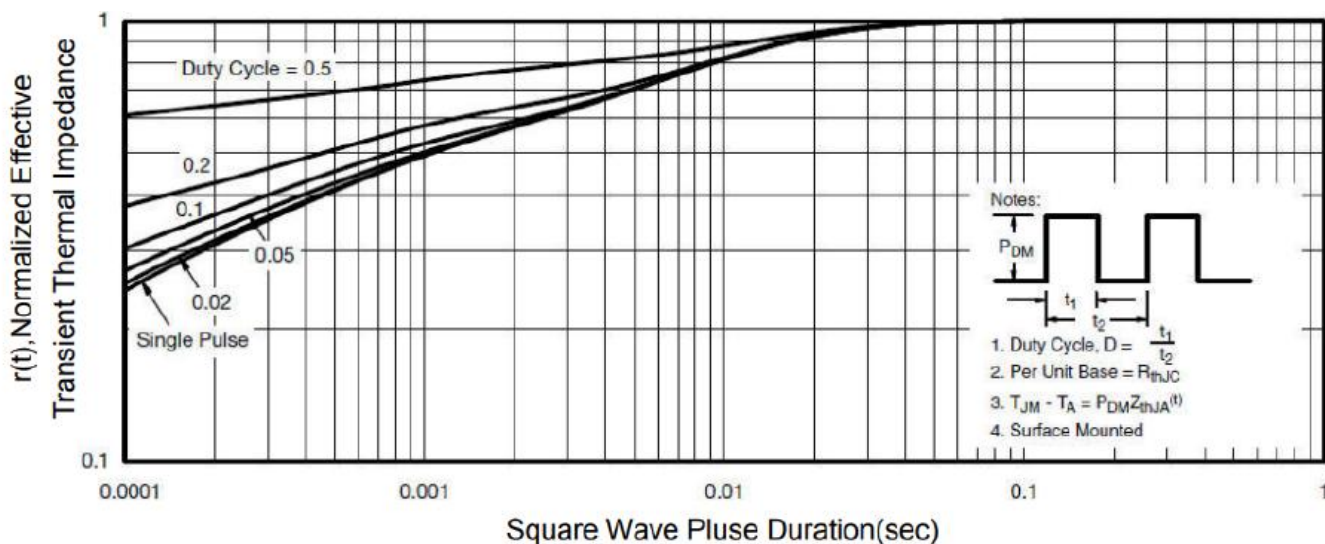

Figure 13: Max. Transient Thermal Impedance

$$Z_{thJC} = f(t_p)$$



Test Circuit and Waveform:

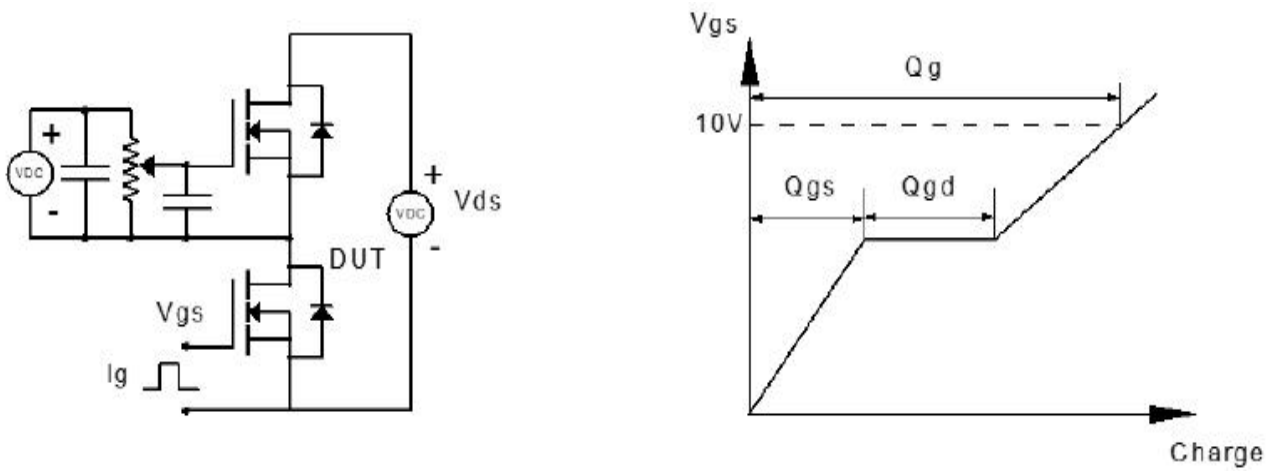

Figure.1: Gate Charge Test Circuit & Waveform

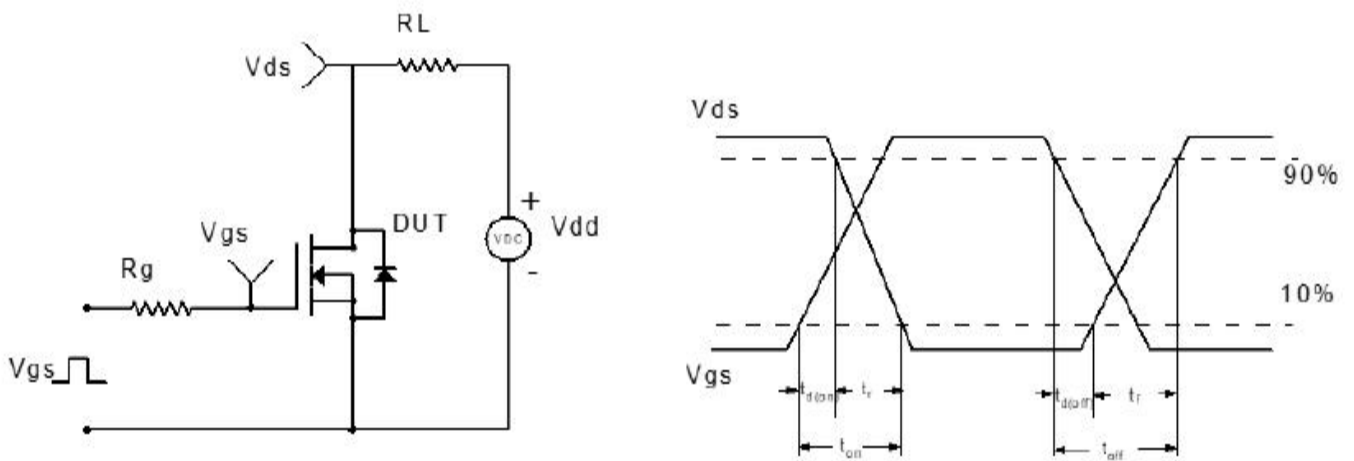

Figure.2: Resistive Switching Test Circuit & Wave forms

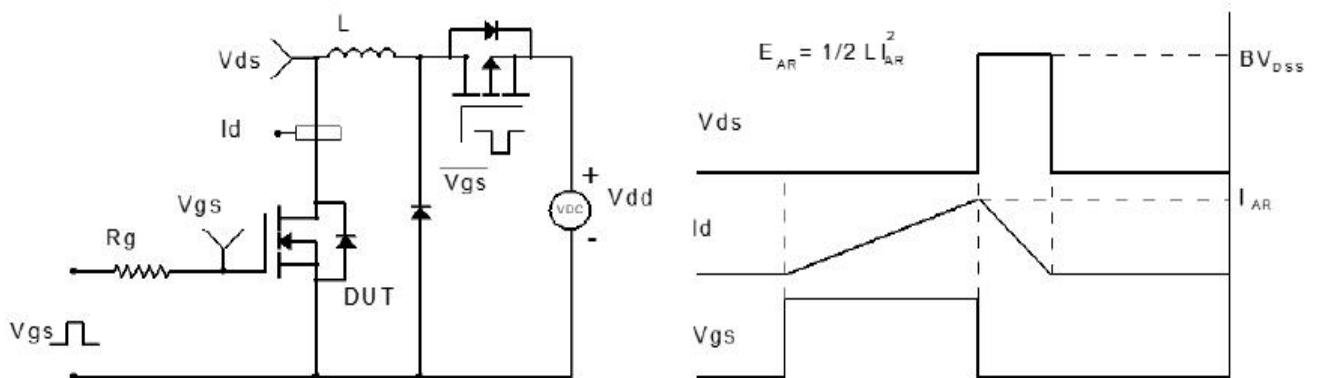

Figure.3: Unclamped inductive Switching Test Circuit & Wave forms

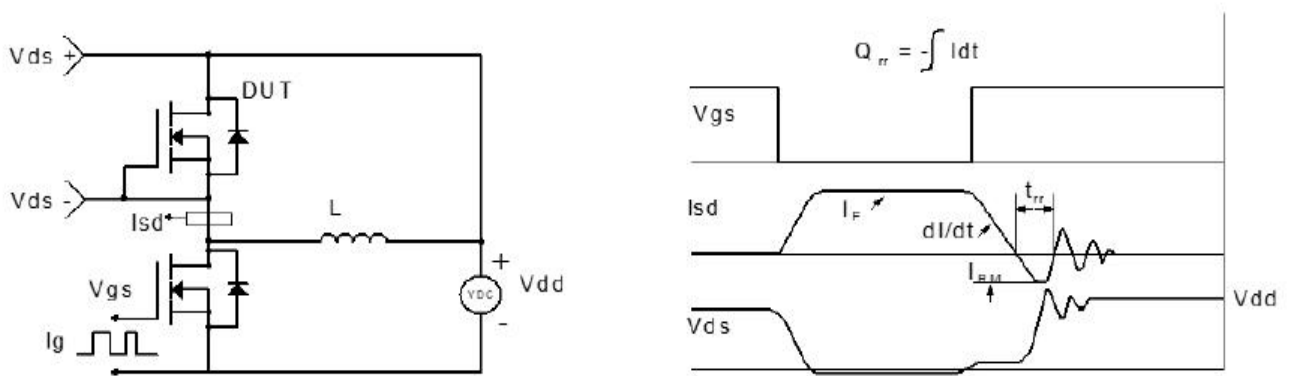
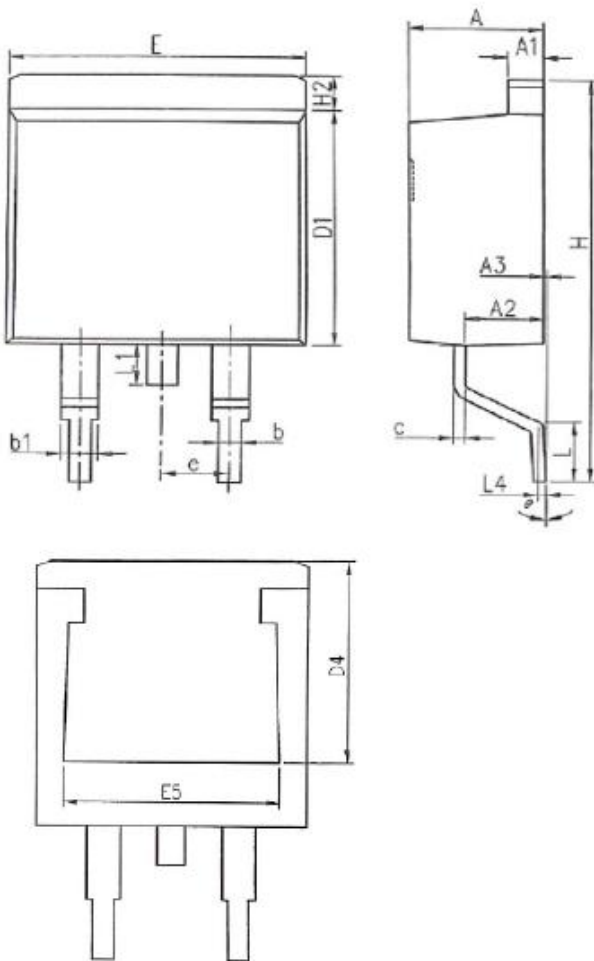

Figure.4: Diode Recovery Test Circuit & Waveform

**Package Dimensions TO263**
**COMMON DIMENSIONS**

SYMBOL	MM	
	MIN	MAX
A	4.37	4.89
A1	1.17	1.42
A2	2.20	2.90
A3	0.00	0.25
b	0.70	0.96
b1	1.17	1.47
c	0.28	0.60
D1	8.45	9.30
D4	6.60	-
E	9.80	10.40
E5	7.06	-
e	2.54BSC	
H	14.70	15.70
H2	1.07	1.47
L	2.00	2.80
L1	-	1.75
L4	0.254BSC	
$\theta$	0°	9°





## Important Notice and Disclaimer

HL Microelectronics reserves the right to make changes to this document and its products and specifications at any time without notice.

Customers should obtain and confirm the latest product information and specifications before final design, purchase or use.

HL Microelectronics makes no warranty, representation or guarantee regarding the suitability of its products for any particular purpose, nor does HL Microelectronics assume any liability for application assistance or customer product design.

HL Microelectronics does not warrant or accept any liability with products which are purchased or used for any unintended or unauthorized application.

No license is granted by implication or otherwise under any intellectual property rights of HL Microelectronics.

HL Microelectronics products are not authorized for use as critical components in life support devices or systems without express written approval of HL Microelectronics.