

V-Series

Contura® II & III

Sealed Rocker Switches

PRODUCT WEBPAGE

request sample, configure part, watch video



Contura® IP66/68 Snap-In Mounted Switches

The V-Series switches are well known for their cutting edge design, high quality, maximum performance and unmatched reliability. These snap-in rocker switches offer countless options for ratings, circuits, colors, illuminations and symbols. These single or double pole switches feature removable actuators in a choice of actuator styles and colors, which may be purchased and stocked separately. An optional plug-in terminal connector enables pre-wiring of wire harness.

1-2
Poles

.4-20
Amps

125-250
VAC

12-24
VDC

Typical Applications

- On/Off-Highway
- Armored Vehicles
- Commercial Food
- Any Application Requiring Sealing Protection
- Marine
- Industrial Automation
- Medical Equipment

Design Features

INTERCHANGEABLE ACTUATORS

Panel redesign is a snap with our wide range of rocker styles. Achieve maximum design variety with minimum inventory. Simply swap rockers to create an entirely new look for your panel.

DUAL SEAL PROTECTION

Seals out water, dust, debris, and sealed to IP66/68 for above-panel components

CLEAN CONNECTIONS

Options for both eight and ten terminal base styles with AMP & Packard compatible connectors affords myriad circuit options while providing ease of assembly.

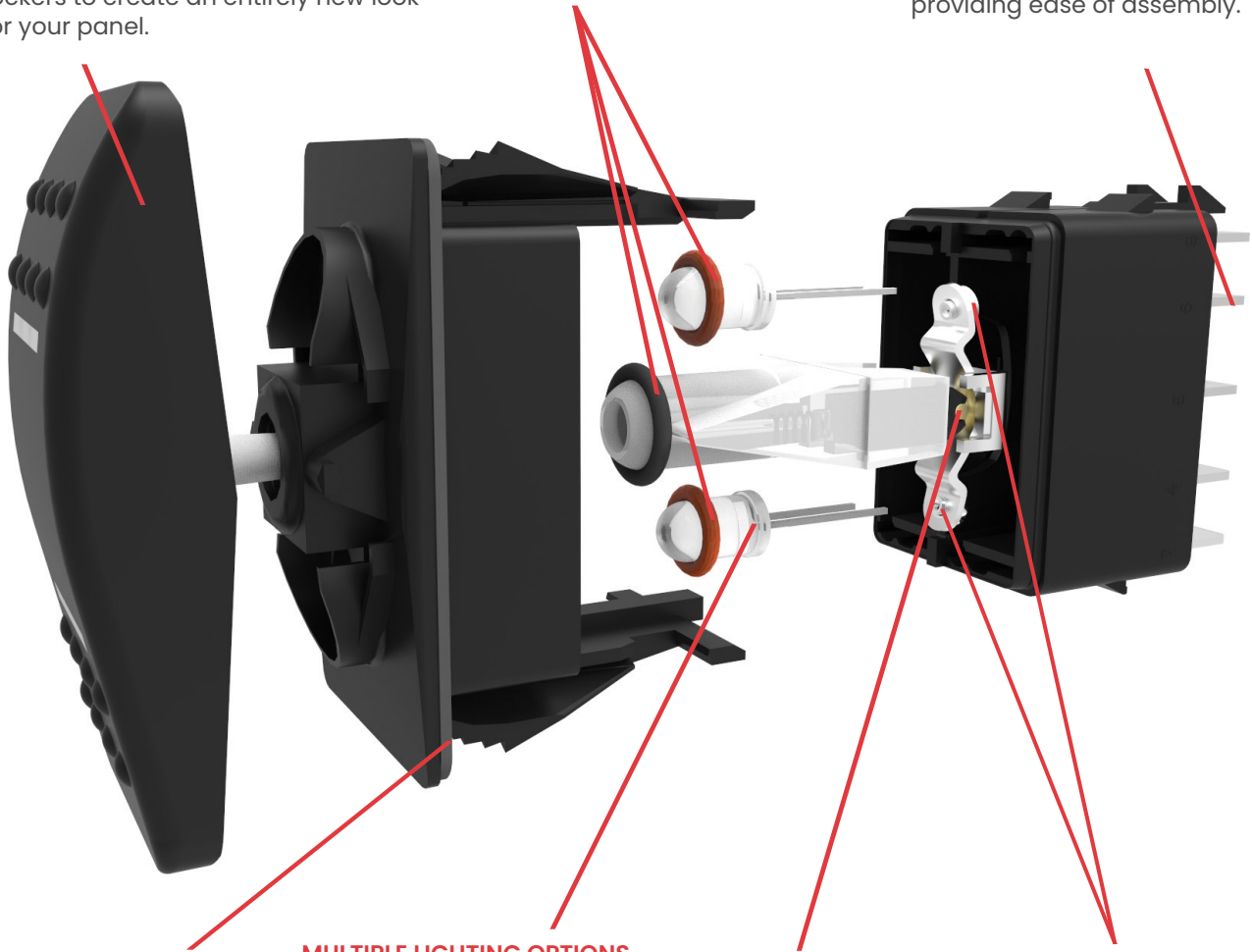

OPTIONAL PANEL SEAL

Helps prevent water/dust ingress behind panel.

MULTIPLE LIGHTING OPTIONS

In addition to Incandescent lamps, our LED illumination is offered in a wide array of light intensities, colors, as well as dual level, tri-color, and flashing options.

BRASS ROLLER PIN

Robust mechanism eliminates the need for lubricants. Enables switch to withstand -40°C to +85°C temperatures.

SILVER PLATED BUTT CONTACT MECHANISM

Providing 50k to 100k electrical cycles, circuit and load dependent

Tech Specs

Electrical

| | |
|----------------------------|--|
| Contact Rating | 4VA @ 24VDC (MAX) resistive 15 amps, 125VAC 10 amps, 250VAC 1/2 HP 125-250VAC 20 amps, 4-14VDC 15 amps, 15-28VDC 10A, 14VT 6A, 125VAC L |
| Dielectric Strength | 1500 Volts RMS |
| Insulation Resistance | 50 Megohms |
| Initial Contact Resistance | 10 milliohms max. @ 4VDC |
| Life | Up to 100,000 cycles, circuit and load dependent |
| Contacts | Silver alloy, silver tin-oxide, fine silver |
| Terminals | Brass or copper/silver plate 1/4" (6.3mm) Quick Connect terminations standard. Solder lug, Wire Lead |

Physical

| | |
|--|---|
| Lighted | Incandescent - rated 10,000 hours Neon - rated 25,000 hours LED - rated 100,000 hours 1/2 life (LED is internally ballasted for voltages to 24VDC) |
| Seals | Internal Optional external gasket panel seal |
| Base | Polyester blend rated to 125°C with a UL flammability rating of 94V0. |
| Contura II, III, IV, V, VI, VII Actuator | Hard Surface: Basic actuator structure molded of thermoplastic polycarbonate with a hard Nylon 66 thermoplastic surface overlay. Soft Surface: Basic actuator structure molded of thermoplastic polycarbonate with an elastomer overlay. |
| Contura X, XI, XII Actuator, VP | Nylon 66 Reinforced rated to 105°C |
| Lens | Polycarbonate rated at 100°C |
| Contura XIV | Polycarbonate lens/sub-rocker with ABS shell |

Actuator Travel (Angular Displacement)

| | |
|-------------|----------------|
| 2 position | 18° |
| 3 positions | 9° from center |

Environmental

| | |
|---------------------|---|
| Sealing | IP66/68, for above-panel components of actual switch only. |
| Corrosion | Mixed Flowing Gas (MFG) Class III 3 year accelerated exposure per ASTM B-827, B-845 Silver and gold contacts |
| Operating Temp | -40°C to +85°C |
| Vibration 1 | Per Mil-Std 202F, Method 204D Test Condition A 0.06 DA or 10G's 10-500 Hz. Tested with VCH connector. Test criteria - No loss of circuit during test, pre and post test contact resistance. |
| Vibration 2 | Resonance search 24-50 Hz 0.40 DA 50-2000 Hz ±10 G's peak Horizontal Axis 3-5 G's max. Random 24 Hz 0.06 PSD-Gsq/Hz 60 Hz 0.50 100 Hz 0.50 200 Hz 0.025 2000 Hz 0.025 No loss of circuit during test; <10µ seconds chatter. |
| Shock | Per Mil-Std 202F, Method 213B, Test Condition K @ 30G's. Tested with VCH connector. Test criteria - No loss of circuit during test, pre and post test contact resistance. |
| Salt Spray | Per Mil-Std 202F, Method 101D, Test Condition A, 96 Hrs. Sealed version only. |
| Dust | Mil STD 810, Method 510.2 Air Velocity 300 Ft/Min Duration 16Hr |
| Thermal Shock | Per Mil-Std 202F, Method 107F, Test Cond. A, -55°C to +85°C. Test criteria -pre and post test contact resistance |
| Moisture Resistance | Per Mil-Std 202F, Method 106F, Test Criteria - pre and post test contact resistance |
| Ignition Protection | All Contura switches with sealed construction meet the requirements of UL1500/ISO8846 for ignition protection, in addition to conformance with EC directive 94/25/EC for marine products. |

Mounting Specifications

Panel Thickness Range
Gaskets Acceptable Panel Thickness
0 .030 to .250 (.76 to 6.35mm)
1 .030 to .109 & .147 to .157 (.76 to 2.77mm & 3.73 to 3.98mm)
Recommended: No gasket with panel thickness of .032, .062, .093, .125, .187 or .250

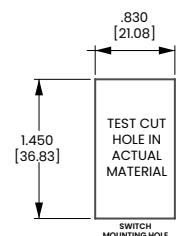

Ordering Scheme

Contura II & III

Sample Part Number

V 1 D A B T 0 B - A R B 00 - 0 00

Selection

1 2 3 4 5 6 7 8 9 10 11 12 13 14

1. SERIES

V V-Series

2. CIRCUIT

Terminal Connections as viewed () - momentary from bottom of switch: SP - single pole: terminals 1, 2 & 3. DP - double pole: terminals 1, 2, 3, 4, 5 & 6. Terminals 7, 8, 9 & 10 for lamp circuit only.

| Position: | 1 | 2 | 3 |
|-----------|--------------|---------------------|--------------|
| SP DP | 2 & 3, 5 & 6 | Connected Terminals | 1 & 2, 4 & 5 |
| 1 A | ON | NONE | OFF |
| 2 B | (ON) | NONE | OFF |
| 3 C | ON | NONE | (OFF) |
| 4 D | ON | NONE | ON |
| 5 F | ON | NONE | (ON) |
| 6 J | ON | OFF | ON |
| 7 K | ON | OFF | (ON) |
| 8 L | (ON) | OFF | (ON) |

| SPECIAL CIRCUITS | 1 | 2 | 3 |
|------------------|----------------|--------------|-------|
| H* | 2 & 3 | 2 & 3, 5 & 4 | 5 & 4 |
| G* | 2 & 3, 5 & 6 | 2 & 3 | OFF |
| S* | 2 & 3, 5 & 6 | 2 & 3 | 1 & 2 |
| M* | (2 & 3, 5 & 6) | 2 & 3 | OFF |
| R* | (2 & 3, 5 & 6) | 2 & 3 | 2 & 1 |
| E* | 5 & 6 | 5 & 3 | 5 & 1 |

Jumper between terminals 2 & 5 for circuits H,G,M,R & S are specified in selection 4. External jumper between terminals 2 & 4 for circuit E are provided by customer. Circuit E may be used for SP OFF-ON-ON circuit.

3. RATING

| | |
|---|--|
| 1 | .4VA @ 28VDC Resistive |
| B | 15A 24V |
| C | 20A 18V |
| D | 20A 12V |
| E | 20A 14V, 10A 14VT (circuit 1, 4, A & D only) |
| F | 10A 14V, 6A 14VT (circuit G only) |
| M | .4VA/20A 12V |
| N | .4VA/15A 24V |

4. TERMINATION / BASE STYLE

| 8 term | 10 Term | Termination | Jumper |
|--------|---------|-----------------------------|-------------|
| 1 | 2 | .250 TAB (QC) no barriers | No |
| A | B | .250 TAB (QC) with barriers | No |
| J | K | .250 TAB (QC) no barriers | Yes T2 to 5 |
| 3 | 4 | Solder Lug no barriers | No |
| C | D | Solder Lug | No |
| 5 | 6 | Wire Leads no barriers | No |
| E | F | Wire Leads | No |

Note: Codes J & K for circuits H, G & M. Do not use silicone based lubricants to reduce terminal insertion forces during connector assembly, as it is detrimental to function and performance.

5. ILLUMINATION

Lamp #1: above terminals 1 & 4 end of switch; Lamp #2 above terminals 3 & 6 end of switch. Positive (+) and negative (-) symbols apply to LED lamps only.

| Sealed | Unsealed | Lamps | illumination Type | Lamp wired to Terminals |
|---------------------------|----------|-------|-------------------|-------------------------|
| S | 0 | NONE | - | - |
| A | 1 | | INDEPENDENT | 8 (+) 7 (-) |
| B | 2 | | DOWN | 3 (+) 7 (-) |
| C | 3 | | UP | 3 (+) 7 (-) |
| D | 4 | | DOWN | 3 (+) 7 (-) |
| E | 5 | | DOWN | 1 (+) 7 (-) |
| F | 6 | | UP | 3 (+) 7 (-) |
| G | 7 | | INDEPENDENT | 8 (+) 7 (-) |
| H | Z | | UP | 3 (+) 7 (-) |
| U | Y | | INDEPENDENT | 8 (+) 7 (-) |
| | | | INDEPENDENT | 10 (+) 9 (-) |
| SINGLE POLE SWITCHES ONLY | | | | |
| J | 8 | | DOWN | 3 (+) 8 (-) |
| | | | INDEPENDENT | 6 (+) 7 (-) |
| K | W | | INDEPENDENT | 8 (+) 7 (-) |
| | | | INDEPENDENT | 6 (+) 7 (-) |
| DOUBLE POLE SWITCHES ONLY | | | | |
| L | 9 | | DOWN | 3 (+) 6 (-) |
| M | R | | UP | 3 (+) 6 (-) |
| N | T | | DOWN | 3 (+) 6 (-) |
| | | | UP | 1 (+) 4 (-) |
| P | V | | DOWN | 1 (+) 4 (-) |
| | | | UP | 3 (+) 6 (-) |

6,7. LAMP (SAME CODING FOR BOTH SELECTIONS)

Selection 6: above terminals 1 & 4; Selection 7: above terminals 3 & 6







| | | | | | |
|--------------|----------|----------|-------------|-------------|-------|
| No lamp | 0 | | | | |
| Neon | 1 125VAC | 2 250VAC | | | |
| Incandescent | 4 3V | 5 6V | 6 12V | 7 18V | 8 24V |
| LED* | | | superbright | superbright | |
| | Red | Amber | Green | Red | |
| 2VDc | A | L | F | R | |
| 6VDc | B | M | G | S | |
| 12VDc | C | N | H | T | |
| 24VDc | D | P | J | V | |

* Consult factory for "daylight bright" LED options. Typical current draw for LED is 20ma.

8. FLUSH BRACKET COLOR, PANEL SEAL

| | | | |
|----------|-------|-------|------|
| No Seal | Black | White | Gray |
| One Seal | B | W | G |
| | C | Y | H |

9. ACTUATOR

| | | | |
|------|-------------|---|---|
| 0 | No Actuator |  |  |
| A, B | Contura II |  |  |
| C, D | Contura III |  |  |

Actuator thick end over terminals: 1, 4, 3, 6

10. LENS

| 0 - No Actuator | Z - No Lens | White | Amber | Green | Red | Blue |
|-----------------|-------------|-------|-------|-------|-----|------|
| 1 | 6 | B | G | M | T | |
| 2 | 7 | C | H | N | U | |
| 3 | 8 | D | J | P | V | |
| 4 | 9 | E | K | R | W | |
| 5 | A | F | L | S | Y | |



Square lens options only available for Contura II.

Lens color for LEDs must be clear, white, or match color of LED. Green or blue lenses are not recommended with Neon lamps.

11. ACTUATOR COLOR AND TEXTURE

| | | | | |
|-----------------|-------|------|-----|-------|
| 0 - No Actuator | Black | Gray | Red | White |
| Soft Surface | B | G | R | W |
| Hard Surface | C | H | S | Y |

12. ACTUATOR LENS OR BODY LEGENDS

| | | | | |
|--------|--------|--------|--------|---|
| 11 ON | 12 OFF | 13 I | 14 O |  |
| OFF | ON | O | I | |
| 15 O O | 16 O O | 17 O I | 18 I O |  |
| F N | N F | F | F | |

For additional legend options & codes, visit us at www.carlingtech.com

13. LEGENDS ORIENTATION

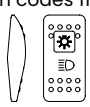
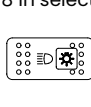
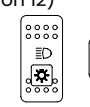
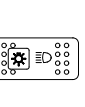
| | | |
|---|---|---|
| 0 | No legend (used with codes 11-18 in selection 12) | |
| 1 | Orientation 1 |  |
| 2 | Orientation 2 |  |
| 3 | Orientation 3 |  |
| 4 | Orientation 4 |  |

14. ACTUATOR LENS LEGENDS

00 No legend this location / no actuator (used with codes 11-18 in selection 12) Selection 14 required when switch requires two legends. If the two legends consist of one lens and one body legend, lens legend must be specified in selection 12; body legend specified in selection 14. For legend options & codes, visit us at www.carlingtech.com.

Notes:

- Consult factory to verify horsepower rating for your particular circuit choice.
- Custom colors are available. Consult factory.
- Body legends not available on Soft surface actuators; White imprinting is standard on black actuators; Black imprinting is standard on white, red and gray actuators. Custom colors are available, consult factory.
- Additional ratings available. See V-Series Switch Accessories page.
- Contura II available with two square lenses. Consult factory for details.

Configure Complete Part Number >

Browse Standard Parts >

Ordering Scheme

Contura II & III locking

Sample Part Number

V 1 D A S W 0 B - A Z E 00 - 0

Selection 1 2 3 4 5 6 7 8 9 10 11 12 13

1. SERIES

V V-Series

2. CIRCUIT

Terminal Connections as viewed () - momentary from bottom of switch: SP - single pole: terminals 1, 2 & 3. 8 terminal 10 terminal DP - double pole: terminals 1, 2, 3, 4, 5 & 6. Terminals 7, 8, 9 & 10 for lamp circuit only.

8 - - 7 8 - - 7
1 - - 4 1 - - 4
2 - - 5 2 - - 5
3 - - 6 3 - - 6
10 - - 9

| Position: | 1 | 2 | 3 |
|-----------|--------------|---------------------|--------------|
| SP DP | 2 & 3, 5 & 6 | Connected Terminals | 1 & 2, 4 & 5 |
| 1 A | ON | NONE | OFF |
| 4 D | ON | NONE | ON |
| 6 J | ON | OFF | ON |
| 7 K | ON | OFF | (ON) |
| 8 L | (ON) | OFF | (ON) |
| 9 N | OFF | NONE | ON |

| SPECIAL CIRCUITS | 2 & 3 | 2 & 3, 5 & 4 | 5 & 4 |
|------------------|----------------|--------------|-------|
| H* | 2 & 3, 5 & 6 | 2 & 3 | OFF |
| G* | 2 & 3, 5 & 6 | 2 & 3 | 1 & 2 |
| S* | (2 & 3, 5 & 6) | 2 & 3 | OFF |
| M* | (2 & 3, 5 & 6) | 2 & 3 | 2 & 1 |
| R* | 5 & 6 | 5 & 3 | 5 & 1 |

*Jumper between terminals 2 & 5 for circuits H,G,M,R & S are specified in selection 4. External jumper between terminals 2 & 4 for circuit E are provided by customer. Circuit E may be used for SP OFF-ON-ON circuit.

3. RATING 4

| | |
|---|--|
| 1 | .4VA @ 28VDC Resistive |
| B | 15A 24V |
| C | 20A 18V |
| D | 20A 12V |
| E | 20A 14V, 10A 14VT (circuit 1, 4, A & D only) |
| F | 10A 14V, 6A 14VT (circuit G only) |
| M | .4VA/20A 12V |
| N | .4VA/15A 24V |

4. TERMINATION / BASE STYLE

| 8 term | 10 Term | Termination | Jumper |
|--------|---------|-----------------------------|-------------|
| 1 | 2 | .250 TAB (QC) no barriers | No |
| A | B | .250 TAB (QC) with barriers | No |
| J | K | .250 TAB (QC) no barriers | Yes T2 to 5 |
| 3 | 4 | Solder Lug no barriers | No |
| C | D | Solder Lug | No |
| 5 | 6 | Wire Leads no barriers | No |
| E | F | Wire Leads | No |

Note: Codes J & K for circuits H, G & M. Do not use silicone based lubricants to reduce terminal insertion forces during connector assembly, as it is detrimental to function and performance.

5. ILLUMINATION & SWITCH SEALING

| Sealed | Unsealed | Lamps | illumination Type | Lamp wired to Terminals |
|---------------------------|----------|-------|-------------------|-------------------------|
| S | 0 | NONE | - | - |
| C | 3 | 2 | UP | 3 (+) 7 (-) |
| H | Z | 2 | INDEPENDENT | 8 (+) 7 (-) |
| DOUBLE POLE SWITCHES ONLY | | | | |
| M | R | 1 | UP | 3 (+) 6 (-) |
| | | 2 | DOWN | 1 (+) 4 (-) |
| P | V | 1 | UP | 1 (+) 4 (-) |
| | | 2 | UP | 3 (+) 6 (-) |

6. LOCK

Lock above terminals 1 & 4 end of switch
W lock

7. LAMP

Lamp above terminals 3 & 6 end of switch

| | | | | | |
|--------------|----------|----------|-------------|-------------|-------|
| No lamp | 0 | | | | |
| Neon | 1 125VAC | 2 250VAC | | | |
| Incandescent | 4 3V | 5 6V | 6 12V | 7 18V | 8 24V |
| LED* | | | superbright | superbright | |
| | Red | Amber | Green | Red | |
| 2VDC | A | L | F | R | |
| 6VDC | B | M | G | S | |
| 12VDC | C | N | H | T | |
| 24VDC | D | P | J | V | |

* Consult factory for "daylight bright" LED options. Typical current draw for LED is 20ma.

8. FLUSH BRACKET COLOR, PANEL SEAL 1

| | | | |
|----------|-------|-------|------|
| No Seal | Black | White | Gray |
| One Seal | B | W | G |
| | C | Y | H |

9. HARD SURFACE ACTUATOR 1

| | | | | |
|-------------|-------|------|-----|-------|
| Contura II | Black | Gray | Red | White |
| | A | B | G | H |
| Contura III | C | D | E | F |

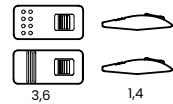
Actuator orientation above terminals: 

10. LENS



| | | | | | |
|-------------|-------|-------|-------|-----|------|
| Z - No Lens | | | | | |
| Clear | White | Amber | Green | Red | Blue |
| 3 | 8 | D | J | P | V |

Lens color for LEDs must be clear, white, or match color of LED. Green or blue lenses are not recommended with Neon lamps.

11. ACTUATOR LOCK FUNCTION AND COLOR 1

| Lock Color | Up | Down | Up & Down | Center ³ |
|----------------|----|------|-----------|---------------------|
| Match Actuator | A | H | R | 1 |
| Black | B | J | S | 2 |
| White | C | K | T | 3 |
| Red | D | L | V | 4 |
| Safety Orange | E | M | W | 5 |

12. ACTUATOR LENS OR BODY LEGENDS 2

| | | | | |
|----------------|----|----|----|---|
| 00 - No Legend | | | | |
| 21 | 22 | 23 | 24 |  |
| OFF | ON | O | I | |
| 25 | 26 | 27 | 28 |  |
| O | O | O | I | |
| F | N | | | |

For additional legend options & codes, visit us at www.carlingtech.com

13. LEGEND ORIENTATION

| | |
|---|---|
| 0 | No legend (used with codes 21-28 in selection 12) |
| 1 | Orientation 1 |
| 2 | Orientation 2 |
| 3 | Orientation 3 |
| 4 | Orientation 4 |

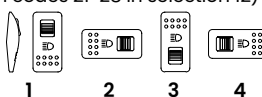

Notes: Consult factory to verify horsepower rating for your particular circuit choice.

- 1 Custom colors are available. Consult factory.
- 2 White imprinting is standard on black actuators; Black imprinting is standard on white, red and gray actuators. Custom colors are available, consult factory.
- 3 Only available with 3 position circuits. Center OFF and special circuits only available with center position lock function.
- 4 Additional ratings available. See V-Series Switch Accessories page.

[Configure Complete Part Number >](#)

[Browse Standard Parts >](#)

Dimensional Specs

inches [millimeters]

CONTURA II

SHOWN WITH
SQUARE LENS

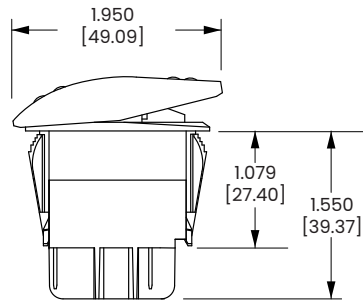
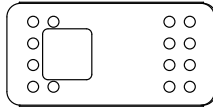

**8 TERMINAL BASE
W/BARRIERS**

CONTURA III

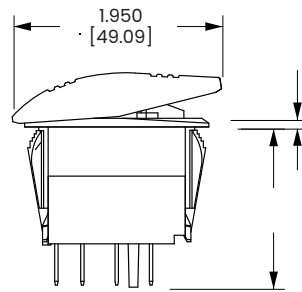
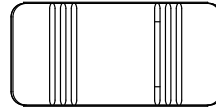

**8 TERMINAL BASE
W/O BARRIERS**

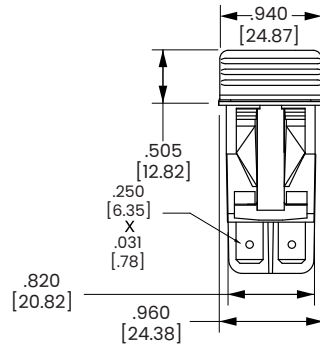
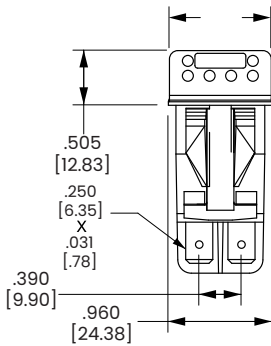

**10 TERMINAL BASE
W/BARRIERS**

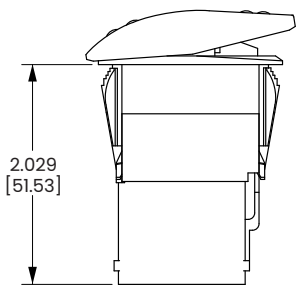

**SWITCH SHOWN WITH
VCH CONNECTOR 8
TERMINAL**

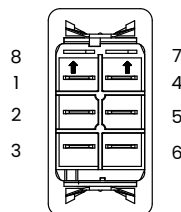

**BOTTOM VIEW
TERMINAL
ARRANGEMENT
8 TERMINAL BASE**

Circuit Diagrams:

| CIRCUIT CODE | CIRCUIT DIAGRAM |
|--------------|-----------------|
| 1 | |
| 2 | |
| 3 | |
| 4 | |
| 5 | |
| 6 | |
| 7 | |
| 8 | |

| CIRCUIT CODE | CIRCUIT DIAGRAM |
|--------------|-----------------|
| A | |
| B | |
| C | |
| D | |
| E | |
| F | |
| G | |
| H | |

| CIRCUIT CODE | CIRCUIT DIAGRAM |
|--------------|-----------------|
| J | |
| K | |
| L | |
| M | |
| R | |
| S | |

| SYMBOL LEGEND | |
|---------------|---|
| SYM. | DEFINITION |
| ○ | DESIGNATES TERMINALS AND CONTACTS |
| —○ | DESIGNATES MAINTAINED CIRCUITS |
| - - | DESIGNATES OTHER POSITION |
| —○ | DESIGNATES MOMENTARY CIRCUITS |
| ⊂ | DESIGNATES TWO POSITION CONNECTION |
| — | DESIGNATES EXTERNAL JUMPER PROVIDED BY CUSTOMER |

Lamp Circuit Diagrams:

| LAMP CIRCUIT CODE | CIRCUIT DIAGRAM | LAMP CIRCUIT CODE | CIRCUIT DIAGRAM | LAMP CIRCUIT CODE | CIRCUIT DIAGRAM | LAMP CIRCUIT CODE | CIRCUIT DIAGRAM |
|-------------------|-----------------|-------------------|-----------------|-------------------|-----------------|-------------------|-----------------|
| A / 1 | | F / 6 | | L / 9 | | SPECIAL #1 | |
| B / 2 | | G / 7 | | M / R | | SPECIAL #3 | |
| C / 3 | | H / Z | | N / T | | SPECIAL #4 | |
| D / 4 | | J / 8 | | P / V | | | |
| E / 5 | | K / W | | U / Y | | | |

J-Series Hazard Warning Circuit Diagrams:

| CIRCUIT CODE | CIRCUIT DIAGRAM | CIRCUIT CODE | CIRCUIT DIAGRAM |
|--------------|-----------------|--------------|-----------------|
| J1 | | J5 | |
| J2 | | JA | |
| J3 | | JJ | |
| J4 | | JK | |

NOTE:
J circuits are available for all non-locking V-Series styles. Consult factory for partnumber details.

| SYMBOL LEGEND | |
|---------------|-----------------------------------|
| SYM. | DEFINITION |
| ○ | DESIGNATES TERMINALS AND CONTACTS |
| ○ | DESIGNATES LAMP LOCATION |

Stand-Alone Components

Reduce inventory levels and cost by stocking actuators and base switches separately.

Contura II, III, IV, V, VI, VII, X, XI, XII, XIV Base switches separately: specify V with code selections 2-8 in the ordering schemes.

Contura II, III, IV, V Actuator only: VV with code A or C for selection 9, & with selections 10-14 in the ordering schemes.

Contura VI Actuator with lenses and inserts only: VT with code selections 9-16

Contura II, III, IV, V, VII Actuator only: VV with code A, C, E, G, P or Z for selection 9 & with selections 10-14 in the ordering schemes.

Contura X, XI, XII, XIV actuators with lenses separately: VV with code selections 9-14 in the ordering schemes.

Panel Seal: VPS

Contura X & XI actuators without lenses separately

VVR 6 1 00 1

1 2 3 4 5

1. CONTURA X & XI ACTUATOR SEPARATELY

VVR

2. ACTUATOR STYLE & COLOR

| | | | | |
|------------|-------|------|-------|-----|
| | Black | Gray | White | Red |
| Contura X | 1 | 2 | 3 | 4 |
| Contura XI | 6 | 7 | 8 | 9 |

3. LENS OPENING FOR 1

| | | | | |
|---|-----------------|--|---|---|
| 1 | One bar lens | | | |
| 2 | Two bar lenses | | | |
| 3 | One square lens | | 5 | square lens on top/ bar lens on bottom (Contura X only) |
| 4 | Two square lens | | | |

4. ACTUATOR LENS OR BODY LEGEND

00 - No Legend this location

| | | | | | | | | |
|----|----|----|-----|----|----|----|---|---|
| 11 | ON | 12 | OFF | 13 | I | 14 | O | |
| | | | OFF | | ON | | O | I |
| 15 | O | 16 | O | 17 | O | 18 | I | O |
| | F | | N | | F | | | |

For additional legend options & code, visit us at www.carlingtech.com

5. LEGEND ORIENTATION 1

| | | | | | |
|---|---------------|--|--|--|--|
| 0 | No legend | | | | |
| 1 | Orientation 1 | | | | |
| 2 | Orientation 2 | | | | |
| 3 | Orientation 3 | | | | |
| 4 | Orientation 4 | | | | |

Contura X, XI & XII top piece of 2-piece lens separately

VVT 1

1 2

1 TOP OF LENS SEPARATELY

VVT

2 COLOR

1 Clear 2 Smoke 3 White

Contura X, XI & XII actuator lens assembly:



1 piece lens/bar lens are positioned the same as bottom lens for assembly, minus the top lens. Lenses snap in from bottom.

Notes:

- If actuator lens opening for 2 bar or 2 square lenses, legend orientation 0,1, or 2 must be chosen.
- Center of actuator marking not available for Contura XII.
- Legend is not available for bar style lens.
- Not recommended with neon lamps.
- Must also order top piece of 2 piece square lens separately.

Contura XII actuators without lenses separately

VVP J 1 Z 21 1 00

1 2 3 4 5 6 7

1 CONTURA XII ACTUATOR SEPARATELY

VVP

2. ACTUATOR STYLE & COLOR

J Black K Gray N White M Red

3,4 LENS OPENING FOR 1

Z No lens 1 Bar lens 2 Square lens

5, 7 LENS OR BODY LEGEND 2

| | | | | | | | | | |
|----|-------------|----|-----|----|----|----|---|----|---|
| 00 | - No Legend | 21 | OFF | 22 | ON | 23 | O | 24 | I |
| | | | | | | | | | |
| | | 25 | O | 26 | O | 27 | O | 28 | I |
| | | | F | | N | | | | |
| | | | F | | | | | | |

For additional legend options & codes, visit us at www.carlingtech.com

6 LEGEND ORIENTATION 3

0 No legend
1 Orientation 1
2 Orientation 2

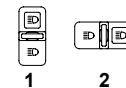

Contura X, XI & XII actuator lens assembly separately

VVL 2 1 00 0

1 2 3 4 5

1 CONTURA X, XI & XII LENS SEPARATELY

VVL

2 LENS STYLE 3

1 Bar lens
2 One Piece Square lens
3 Bottom of Two-Piece Square lens⁵

3 TRANSLUCENT LENS COLOR

1 Clear 2 White 3 Amber 4 Green⁴ 5 Red 6 Blue⁴

4 LENS OR BODY LEGEND 2

| | | | | | | | | | |
|----|-------------|----|-----|----|----|----|---|----|---|
| 00 | - No Legend | 21 | OFF | 22 | ON | 23 | O | 24 | I |
| | | | | | | | | | |
| | | 25 | O | 26 | O | 27 | O | 28 | I |
| | | | F | | N | | | | |
| | | | F | | | | | | |

For additional legend options & codes, visit us at www.carlingtech.com.

5 LEGEND ORIENTATION 3

0 No legend
1 Orientation 1
2 Orientation 2
3 Orientation 3
4 Orientation 4

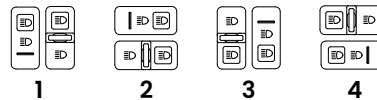

Accessories

Easily integrate Contura products into your system, with Contura Accessories

Contura Connectors



| Q.C. SELECTION GUIDE | | | | | | |
|-------------------------------|-------------|------------------|------------|-----------------------|-------------|-------|
| COMPANY SERIES | PART NO | | WIRE RANGE | | ORIENTATION | |
| | PLAIN BRASS | TIN PLATED BRASS | AWG | MM ² (REF) | | |
| PACKARD 58 SERIES | 02965580 | | 12 | 3.0 | B | |
| | 02965471 | 12010601 | (2)16-14 | (2)1.0-2.0 | | |
| | 02965470 | | 16-14 | 1.0-2.0 | | |
| | 02965469 | 06288318 | 20-18 | .5-.8 | | |
| PACKARD METRI-PACK 630 SERIES | | 12084590 | 105.0 | | A | |
| | | 12052224 | 123.0 | | | |
| | | 12015870 | 16-14 | 1.0-2.0 | | |
| | | 12020035 | (2)22-18 | (2).5-.8 | | |
| | | 12015832 | 12015869 | 20-18 | | .5-.8 |
| | | 12052222 | 20-22 | .35-.5 | | |
| AMP 250 SERIES FASTIN-FASTON | 60253-1 | 60253-2 | 16-12 | 1.3-3 | B | |
| | 42100-1 | 42100-2 | 18-14 | .8-2 | | |
| | 60295-1 | 60295-2 | 22-18 | .3-9 | | |

NOTE: Consult Delphi Packard and/or Amp on actual part numbers and availability. AMP is a registered trademark of AMP Inc. Harrisburg, PA. Delphi Packard is a registered trademark of Delphi-Packard Electrical Systems Warr

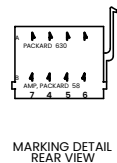
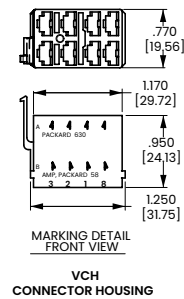
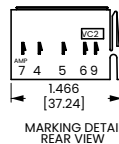
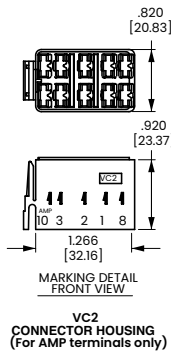
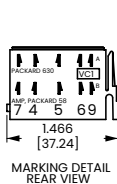
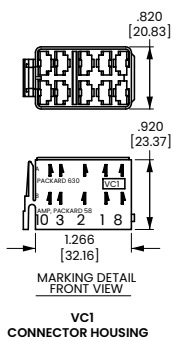
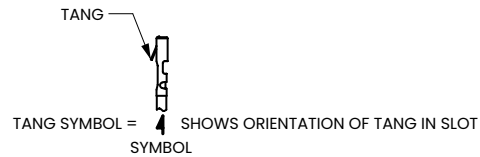

Contura X Boot (P/N VB1-01)

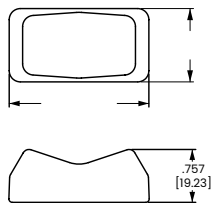

Contura II, III, IV, V, VI & VII Actuator Removal Tool (P/N VRT)

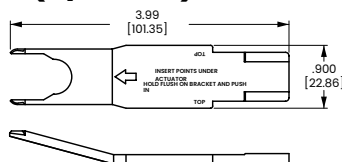

Additional V-Series Ratings

- 1 .4VA @ 28VDC Resistive
- 4 10A 250VAC 1/2 HP, 15A 125 VAC 1/2 HP, No Agency Listings
- 5¹ 10A 250VAC 1/2 HP, 15A 125 VAC 1/2 HP, UL Recognized, CSA Certified
- B 15A 24V
- C 20A 18V
- D 20A 12V
- E 20A 14V, 10A 14VT (circuits 1, 4, A, & D only)
- F 10A 14V, 6A, 14VT (circuit G only)
- G 20A 6V
- H 20A 3V
- L² 15A 125 VAC, 10A 250VAC, 1/2 HP 125-250 VAC; 6A 125 VAC L
- M .4VA/20A 12V (combi-contact) (combination gold/silver contacts for borderline dry circuit applications)
- N .4VA/15A 24V (combi-contact) (combination gold/silver contacts for borderline dry circuit applications)

NOTES

Consult factory to determine availability for individual circuits and their HP rating.

1. Not available with Contura 7 or 14 rocker styles.
2. Rating L available with circuits 1, 4, A & D only.

Accessories

Contura Mounting Panels Dimensional Specifications: in. [mm]

MOUNTING PANEL
For additional units, add 1.03 [26.2] per unit. For more than 2 V-Series Switches, add middle section. Available in panel Thicknesses listed below. Consult factory.

| MOUNTING PANEL THICKNESS | |
|--------------------------|--------|
| .62 | .87 |
| [15.7] | [21.9] |
| .98 | .250 |
| [24.9] | [6.35] |
| .25 | .375 |
| [6.35] | [9.52] |

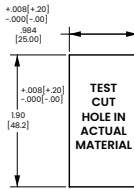

VMS MOUNTING PANEL HOLE

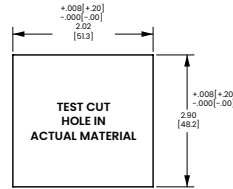

MOUNTING PANEL OPENING (2) UNITS

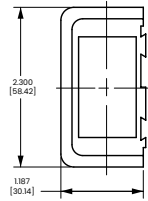

VME MOUNTING PANEL END

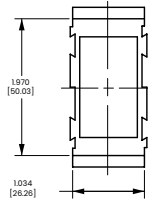

VMM MOUNTING PANEL MIDDLE

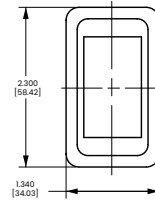

VMS MOUNTING PANEL

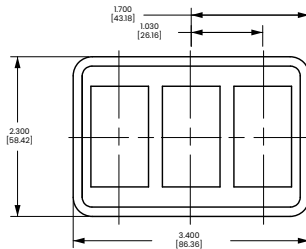

VM3 MOUNTING PANEL

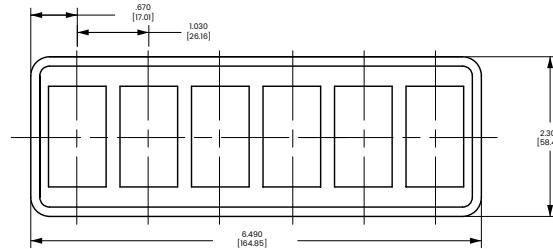

VM6 MOUNTING PANEL



Contura Hole Plug Dimensional Specifications: in. [mm]

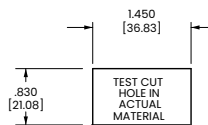

VHP CONTURA II,III HOLE PLUG

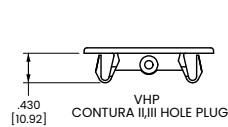

VHP CONTURA II,III HOLE PLUG

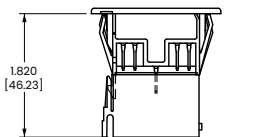

VHI STANDARD HOLE PLUG (No wing serrations) (With VC1 connector attached)

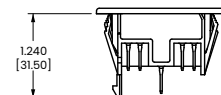

VH2 STANDARD HOLE PLUG (With wing serrations)

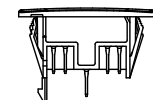
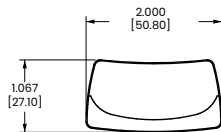

VH3 CONTURA IV HOLE PLUG (No wing serrations)

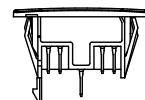

VH4 CONTURA IV HOLE PLUG (With wing serrations)



DETAIL VIEW VH1, VH3 & VH5 HOLE PLUGS (No wing serrations for ease of removal)

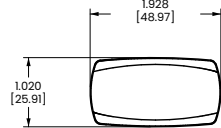

VH5 CONTURA V HOLE PLUG (No wing serrations)

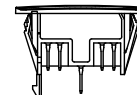

VH6 CONTURA V HOLE PLUG (With wing serrations)



DETAIL VIEW VH2, VH4 & VH6 HOLE PLUGS (With wing serrations)

Authorized Sales Representatives and Distributors

Click on a region of the map below to find your local representatives and distributors or visit www.carlingtech.com/findarep.



About Carling

Founded in 1920, Carling Technologies is a leading manufacturer of electrical and electronic switches and assemblies, circuit breakers, electronic controls, power distribution units, and multiplexed power distribution systems. With six ISO9001 and IATF16949 registered manufacturing facilities and technical sales offices worldwide, Carling Technologies Sales, Service and Engineering teams do much more than manufacture electrical components, they engineer powerful solutions! To learn more about Carling please visit www.carlingtech.com/company-profile.

To view all of Carling's environmental, quality, health & safety certifications please visit www.carlingtech.com/environmental-certifications.

Mouser Electronics

Authorized Distributor

Click to View Pricing, Inventory, Delivery & Lifecycle Information:

[Carling Technologies:](#)

[VLD4UGMB-AAC00-000](#) [V6D2D66B-00000-000](#) [V6D2GHNB-00000-000](#) [V4D2GHNB-00000-000](#) [V4D2D66B-00000-000](#) [V5D1A60B-AEC00-000](#) [V6D1A60B-AEC00-000](#) [VAD1B60B-ARC00-000](#) [VL52U11C-AHC84-200](#) [VDD2YNHB-C2C00-000](#) [V2D1A60B-CMC00-000](#) [V1D1J66B-AAB00-000](#) [V1D1JCAB-AAB00-000](#) [VJD2GHNB-00000-000](#) [V1D1SW0C-CZD00-0](#) [VBD2B60C-A9C4E-100](#) [VMD2GHNB-00000-000](#) [VJB1DPPC-00000-000](#) [VJDBUCCC-00000-000](#) [V4D2S00B-00000-000](#) [V6D2AH0B-00000-000](#) [VA5AS00C-AZC00-000](#) [V1B1AD0B-00000-000](#) [V1D1AC0B-00000-000](#) [V4DAB60B-AKC00-000](#) [V4D2UHNB-00000-000](#) [V2D2AH0B-00000-000](#) [V2D2BN0C-A9CMG-100](#) [V1D2UHNB-00000-000](#) [VLDAA60B-A9C00-000](#) [VDD1A60B-AKC00-000](#) [V6D2UHNB-00000-000](#) [VMD2UHNB-AAC00-000](#) [V1D1CWTB-A8L00-0](#) [VKD1A60B-00000-000](#) [VJD2S00B-AZC00-000](#) [V8B1S00C-AZC00-000](#) [V1D1BH0C-A4B00-000](#) [V1B1BJ0C-A4G00-000](#) [VAB1BJ0C-A4R00-000](#) [VDB2UJPB-AAC00-000](#) [V5B2S00B-AZC00-000](#) [VA51S00C-AZC00-000](#) [VD11A60B-00000-000](#) [VAD2UNN1-13300-000](#) [V4B2HWJB-A8W00-0](#) [V4B2AJ0C-AKCMH-300](#) [VGD1A60B-CGC00-000](#) [V8D1K66B-AAC00-000](#) [VFDA000B-00000-000](#) [VLD1170B-00000-000](#) [VMDABT0B-ARB00-000](#) [V1DASW0B-AZM00-0](#) [V2D2UHNB-AAC00-000](#) [V8BAAV0B-A9C00-000](#) [V1D2GTTB-ASC00-000](#) [VLB2UJPB-AAC00-000](#) [VMD2B60B-A9C00-000](#) [VLB2A80B-ARC00-000](#) [VDB2A80B-ARC00-000](#) [VAD2BN0C-A9C45-100](#) [VA5AAJ0B-AKC13-000](#) [VDL2S00B-AZC00-000](#) [VL51S00W-CZW00-000](#) [V1D1GTTB-AAC00-000](#) [V5D1000B-AZB00-00](#) [VFD1S001JZZ0000](#) [V151B20C-00000-000](#) [V15AS00C-AZB00-000](#) [V1D1B60B-AEC00-000](#) [V2D1000B-AZC00-000](#) [V2D1S00B-AZS00-000](#) [V6D1S00B-AZC00-000](#) [VAD1S00B-AZC00-000](#) [VB12S00C-AZX00-000-XBLU1](#) [V1BABJ0C-AKB45-100](#) [VL12S00C-AZB00-000](#) [VA12S00C-AZX00-000-XBLU1](#) [VDB2S00B-AZC00-000](#) [V1B2B80B-AKC13-000](#) [V1B2B80B-A9C13-000](#) [V851S00C-AZH00-XWA1](#) [V1D1S00C-AZC13-000](#) [V1D2B60B-AKC00-000](#) [VAB1SW0B-AZW00-0](#) [VB12S00C-AZB00-000](#) [VD12S00C-AZB00-000](#) [V6D1S00C-AZB00-000](#) [VDD1S00C-AZC00-000](#) [VK51S00B-AZC00-000](#) [VL51S00B-AZC00-000](#) [VLB1S00B-AZB00-000](#) [VLD2000B-AZC00-000](#) [V1D1S00B-AZS11-000](#) [VAD2S00B-AZC00-000](#) [VBDAS00B-AZB00-000](#) [VDD1AC0B-A4B00-000](#) [VDD1S00B-AZB00-000](#) [VEDAS00B-AZC00-000](#) [V15AA10C-ARC00-000](#)