

## ASMW-PWG0-NxxxD HE 2835 Surface Mount LED

### Description

The Broadcom<sup>®</sup> ASMW-PWG0-NxxxD surface mount LEDs use InGaN chip technology with superior package design to enable them to produce higher light output with better flux performance. They can be driven at high current and are able to dissipate the heat more efficiently resulting in better performance with higher reliability.

These LEDs operate under a wide range of environmental conditions making ideal for various applications, including fluorescent replacement, under cabinet lighting, retail display lighting, and panel lights.

To facilitate easy pick-and-place assembly, the LEDs are packed in tape and reel. Every reel is shipped in single flux and color bin, to provide close uniformity

### Features

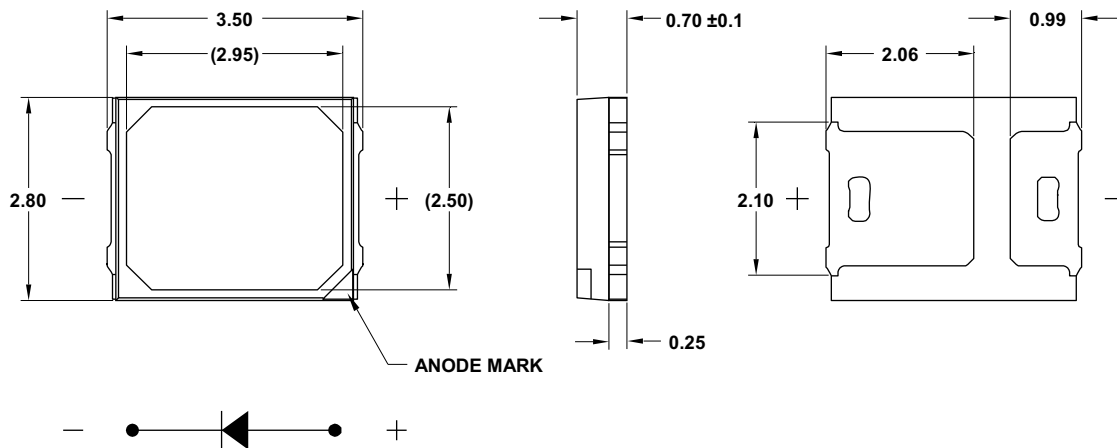
- High reliability package with enhanced silicone resin encapsulation
- Available in 3000K, 3500K, 4000K, 5000K, and 6500K CCT
- CRI  $\geq$  80
- Wide viewing angle at 120°
- Low package profile and large emitting area for better uniformity in linear lighting
- JEDEC MSL 3

### Applications

- For lighting and luminaires
- Electronic signs and signals
  - Channel lettering
  - Contour lighting
  - Indoor variable message sign
- Office automations, home appliances, industrial equipment
  - Front panel backlighting
  - Push button backlighting
  - Display backlighting
  - Scanner lighting

**CAUTION!** This LED is ESD sensitive. Observe appropriate precautions during handling and processing. Refer to application note AN-1142 for additional details.

Figure 1: Package Drawing



**NOTE:**

1. All dimensions are in millimeters (mm).
2. Tolerance is  $\pm 0.20$  mm unless otherwise specified.
3. Encapsulation = silicone.
4. Terminal finish = silver plating.
5. Dimensions in parentheses are for reference only.

**Device Selection Guide ( $T_J = 25^\circ\text{C}$ ,  $I_F = 65$  mA)**

Part Number	Correlated Color Temperature, CCT (Kelvin)	Luminous Flux, $\Phi_V(\text{lm})^{a, b}$			Luminous Efficiency (lm/W)
	Typ.	Min.	Typ.	Max.	
ASMW-PWG0-NNPBD	3000	25.5	31.0	36.0	167.9
ASMW-PWG0-NNPCD	3500	25.5	31.0	36.0	167.9
ASMW-PWG0-NPQDD	4000	30.3	33.6	42.8	182.0
ASMW-PWG0-NPQED	5000	30.3	33.6	42.8	182.0
ASMW-PWG0-NPQHD	6500	30.3	32.8	42.8	177.7

a. The luminous flux,  $\Phi_V$  is measured at the mechanical axis of the package and it is tested with a single current pulse condition.

b. Tolerance is  $\pm 12\%$ .

## Absolute Maximum Ratings

Parameters	ASMW-PWG0-NxxxD	Units
DC Forward Current <sup>a</sup>	350	mA
Peak Forward Current <sup>b</sup>	500	mA
Power Dissipation	1085	mW
Reverse Voltage	Not designed for reverse bias operation	
LED Junction Temperature	125	°C
Operating Temperature Range	-40 to +100	°C
Storage Temperature Range	-40 to +100	°C

a. Derate linearly as shown in [Figure 18](#) and [Figure 19](#).

b. Duty factor = 10%, frequency = 1 kHz.

## Optical and Electrical Characteristics ( $T_J = 25^\circ\text{C}$ , $I_F = 65\text{ mA}$ )

Parameters	Min.	Typ.	Max.	Units
Viewing Angle, $2\theta_{1/2}$ <sup>a</sup>	—	120	—	°
Forward Voltage, $V_F$ <sup>b</sup>	2.70	2.84	3.10	V
Reverse Voltage, $V_R$ at $I_R = 10\ \mu\text{A}$ <sup>c</sup>	5.0	—	—	V
Color Rendering Index, CRI	80	—	—	
Thermal Resistance, $R_{\theta J-S}$ <sup>d</sup>	—	20	—	°C/W

a.  $\theta_{1/2}$  is the off-axis angle where the luminous intensity is half of the peak intensity.

b. Forward voltage tolerance is  $\pm 0.1\text{V}$ .

c. Indicates product final test condition. Long term reverse bias is not recommended.

d. Thermal resistance from the LED junction to the solder point.

## Performance Characteristics (T<sub>J</sub> = 25°C)

Forward Current (mA)	Relative Luminous Flux (Normalized at 65 mA)	Luminous Flux, Φ <sub>V</sub> (lm)	Forward Voltage, V <sub>F</sub> (V)	Luminous Efficiency (lm/W)
		Typ.	Typ.	Typ.
<b>3000K and 3500K</b>				
20	0.32	9.9	2.67	185.8
65	1.00	31.0	2.84	167.9
80	1.21	37.5	2.89	162.2
100	1.49	46.2	2.96	156.0
120	1.76	54.6	3.03	150.1
150	2.14	66.3	3.13	141.3
200	2.75	85.3	3.28	130.0
250	3.31	102.6	3.42	120.0
300	3.84	119.0	3.55	111.8
350	4.35	134.9	3.68	104.7
<b>4000K and 5000K</b>				
20	0.32	10.8	2.67	201.3
65	1.00	33.6	2.84	182.0
80	1.21	40.7	2.89	175.8
100	1.49	50.1	2.96	169.1
120	1.76	59.1	3.03	162.6
150	2.14	71.9	3.13	153.2
200	2.75	92.4	3.28	140.9
250	3.31	111.2	3.42	130.1
300	3.84	129.0	3.55	121.1
350	4.35	146.2	3.68	113.5
<b>6500K</b>				
20	0.32	10.5	2.67	196.6
65	1.00	32.8	2.84	177.7
80	1.21	39.7	2.89	171.7
100	1.49	48.9	2.96	165.1
120	1.76	57.7	3.03	158.8
150	2.14	70.2	3.13	149.5
200	2.75	90.2	3.28	137.5
250	3.31	108.6	3.42	127.0
300	3.84	126.0	3.55	118.3
350	4.35	142.7	3.68	110.8

# Part Numbering System

A S M W - P W G 0 - N 

x <sub>1</sub>	x <sub>2</sub>	x <sub>3</sub>	x <sub>4</sub>
----------------	----------------	----------------	----------------

Code	Description	Option	
x <sub>1</sub>	Minimum Flux Bin	Refer to Flux Bin Limits (CAT) table	
x <sub>2</sub>	Maximum Flux Bin		
x <sub>3</sub>	Color Correlated Temperature	B	3000K
		C	3500K
		D	4000K
		E	5000K
		H	6500K
x <sub>4</sub>	Test Option	D	Test Current = 65 mA

## Part Number Example

ASMW-PWG0-NPQHD

- x<sub>1</sub>: P – Minimum flux bin P
- x<sub>2</sub>: Q – Maximum flux bin Q
- x<sub>3</sub>: H – CCT 6500K
- x<sub>4</sub>: D – Test current = 65 mA

## Bin Information

### Flux Bin Limits (CAT)

Bin ID	Luminous Flux, $\Phi_V$ (lm)	
	Min.	Max.
N	25.5	30.3
P	30.3	36.0
Q	36.0	42.8

Tolerance =  $\pm 12\%$ .

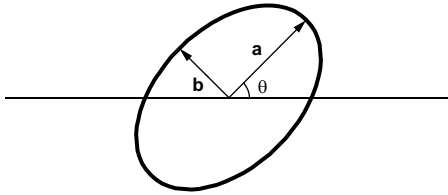
### Forward Voltage Bin Limits ( $V_F$ )

Bin ID	Forward Voltage, $V_F$ (V)	
	Min.	Max.
G02	2.7	2.8
G03	2.8	2.9
G04	2.9	3.0
G05	3.0	3.1

Tolerance =  $\pm 0.1V$ .

### Color Bin Limits (BIN)

Figure 2: 5-Step MacAdam Ellipse Color Definition



Bin ID	CCT	Center Point		Major Axis, a	Minor Axis, b	Ellipse Rotation Angle, $\theta$
		x	y			
B5	3000	0.4338	0.403	0.01399	0.00685	54.00
C5	3500	0.4073	0.3917	0.01466	0.00683	54.53
D5	4000	0.3818	0.3797	0.01547	0.00679	54.05
E5	5000	0.3447	0.3553	0.01403	0.00593	58.22
H5	6500	0.3123	0.3282	0.01094	0.00452	57.65

Chromaticity coordinate tolerance =  $\pm 0.01$ .

Example of bin information on reel and packaging label:

- CAT: N – Flux bin N
- BIN: B5 – Color bin B5
- VF: G03 – VF bin G03

Figure 3: Chromaticity Diagram

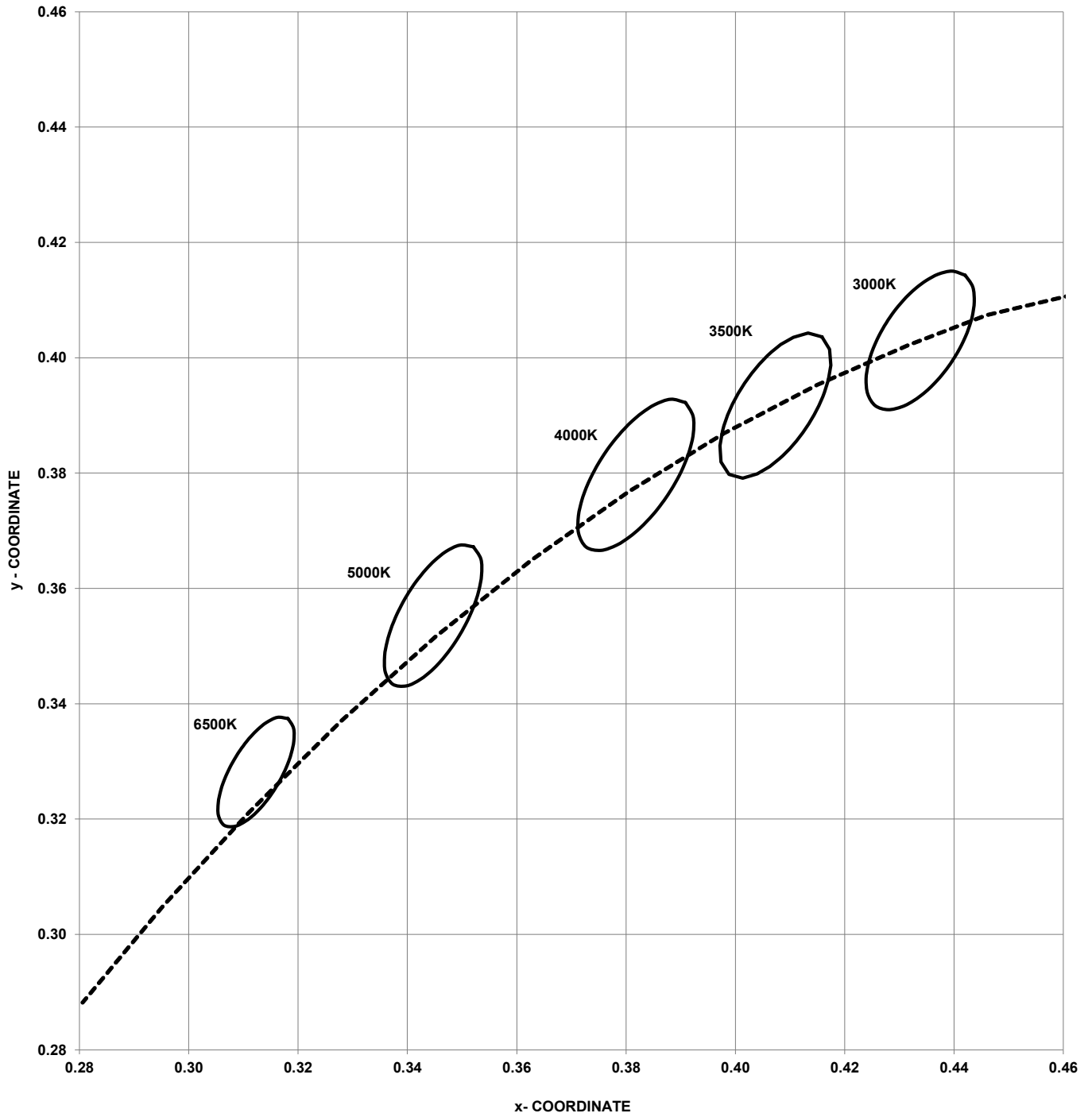


Figure 4: Spectral Power Distribution

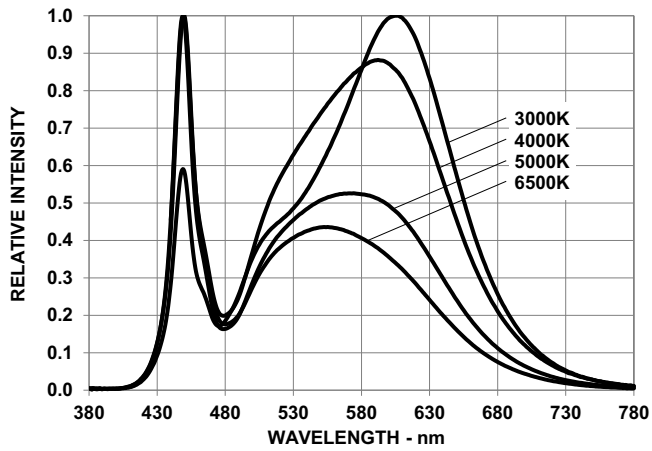


Figure 5: Forward Current vs. Forward Voltage

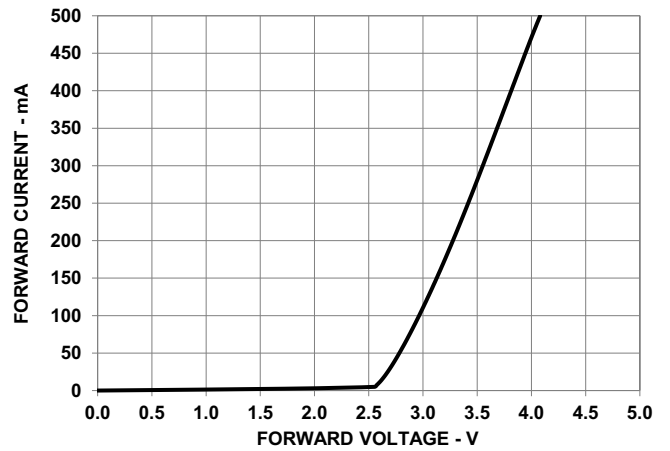


Figure 6: Relative Luminous Flux vs. Mono Pulse Current

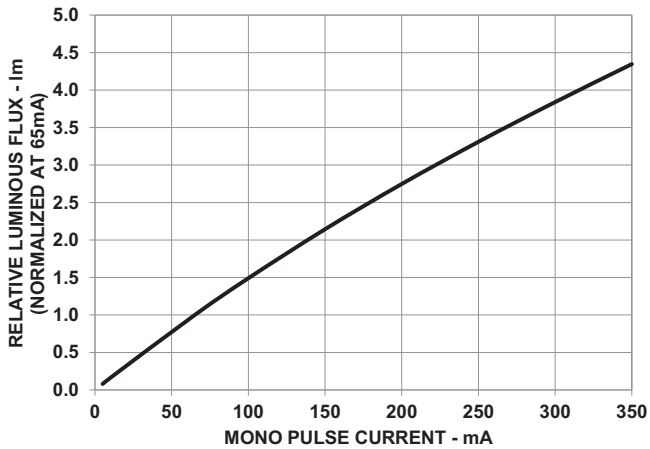


Figure 7: Radiation Pattern

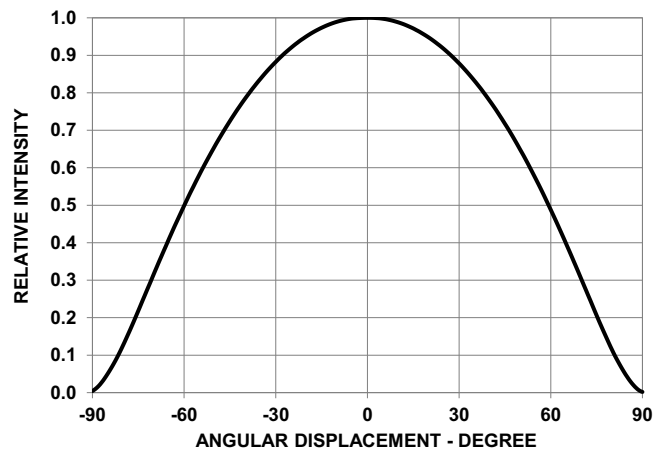


Figure 8: Chromaticity Coordinate Shift vs. Mono Pulse Current for 3000K

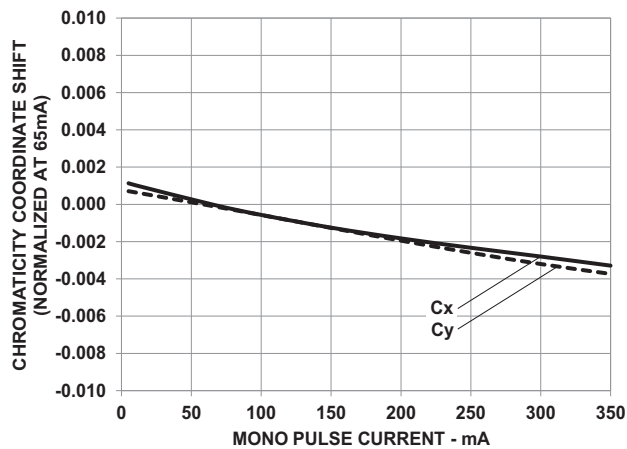
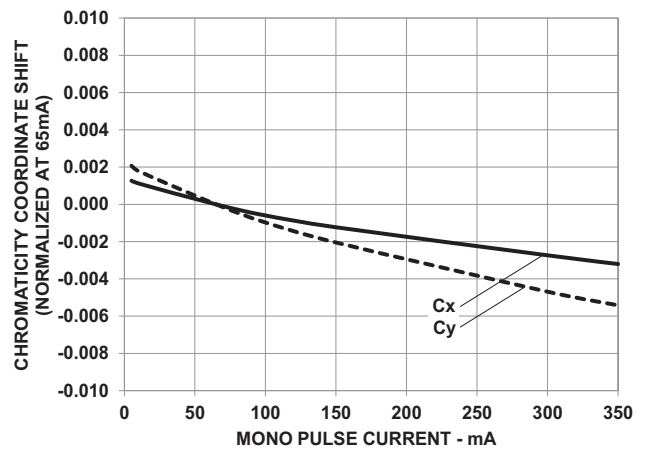
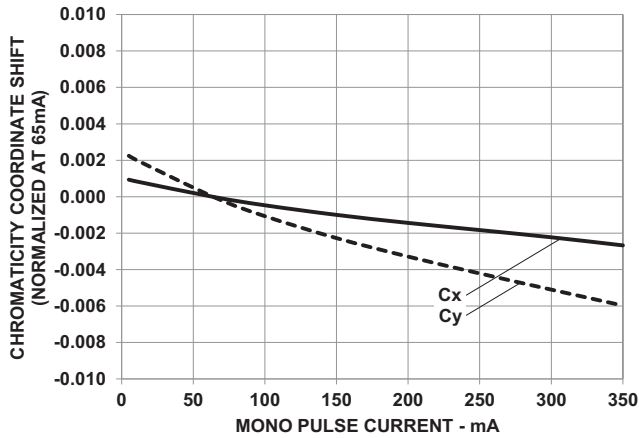


Figure 9: Chromaticity Coordinate Shift vs. Mono Pulse Current for 4000K

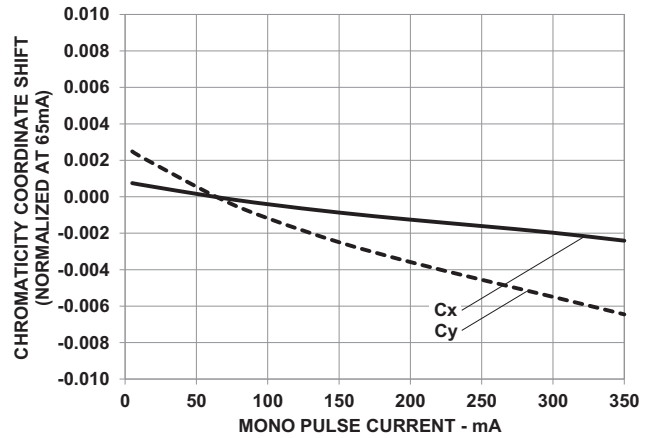




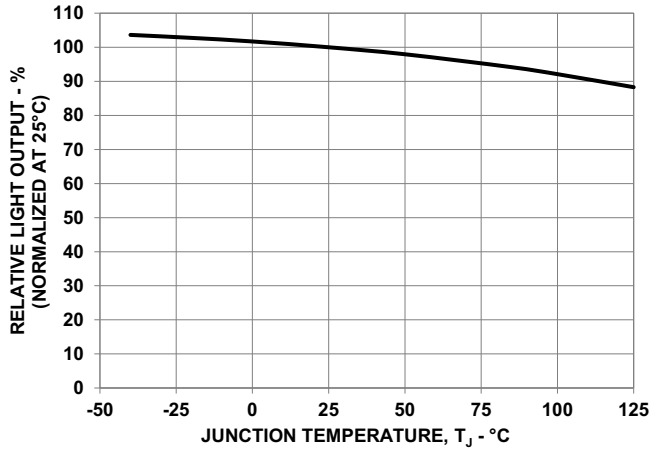
**Figure 10: Chromaticity Coordinate Shift vs. Mono Pulse Current for 5000K**



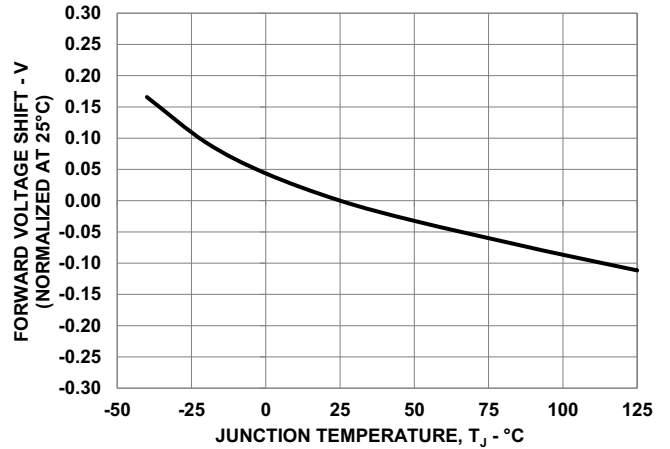
**Figure 11: Chromaticity Coordinate Shift vs. Mono Pulse Current for 6500K**



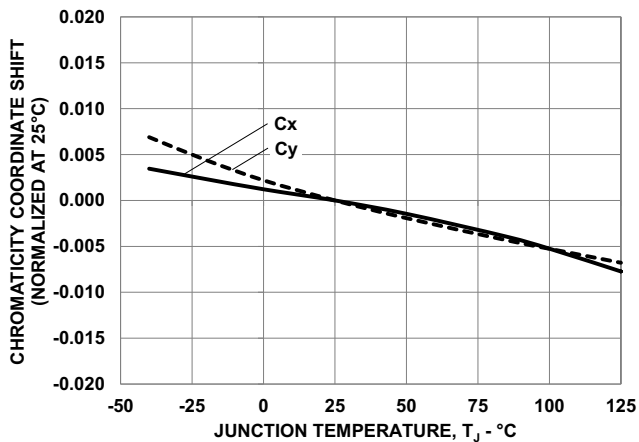
**Figure 12: Relative Light Output vs. Junction Temperature**



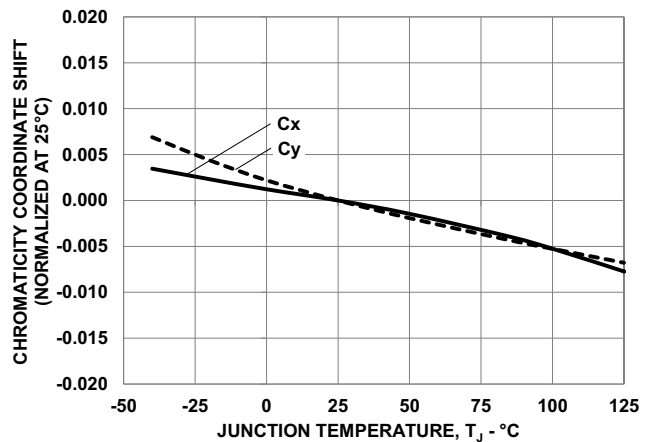
**Figure 13: Forward Voltage Shift vs. Junction Temperature**



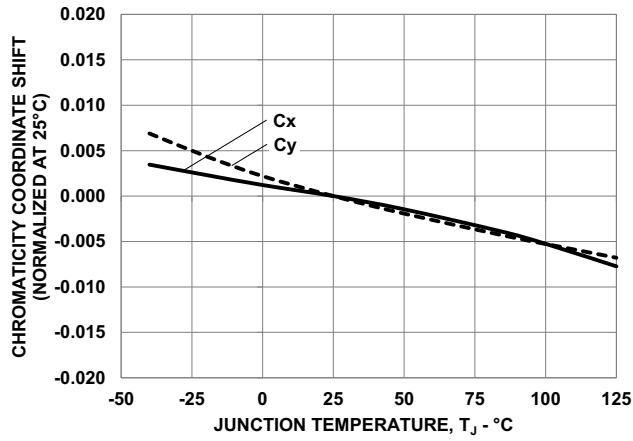
**Figure 14: Chromaticity Coordinate Shift vs. Junction Temperature for 3000K**



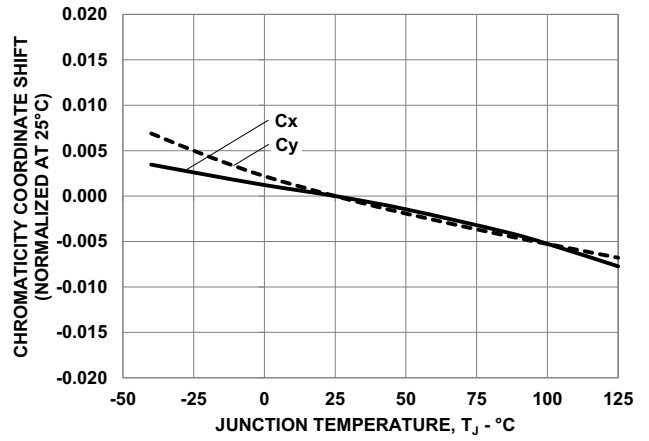
**Figure 15: Chromaticity Coordinate Shift vs. Junction Temperature for 4000K**



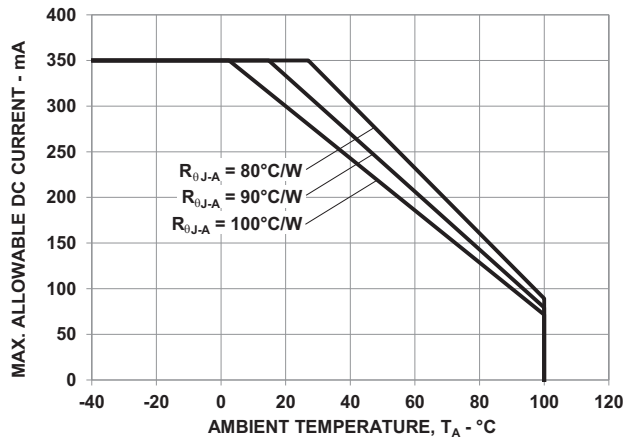
**Figure 16: Chromaticity Coordinate Shift vs. Junction Temperature for 5000K**



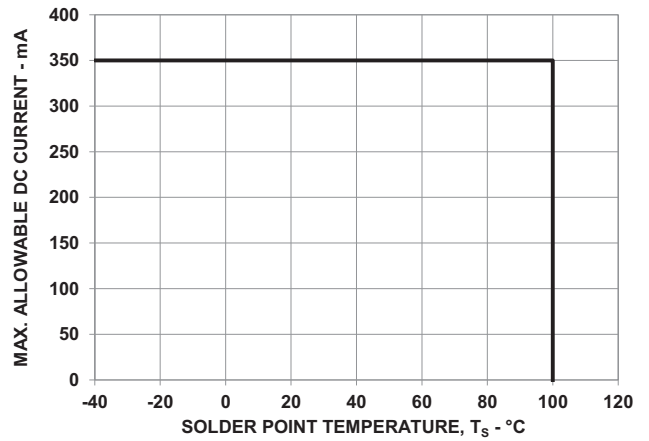
**Figure 17: Chromaticity Coordinate Shift vs. Junction Temperature for 6500K**



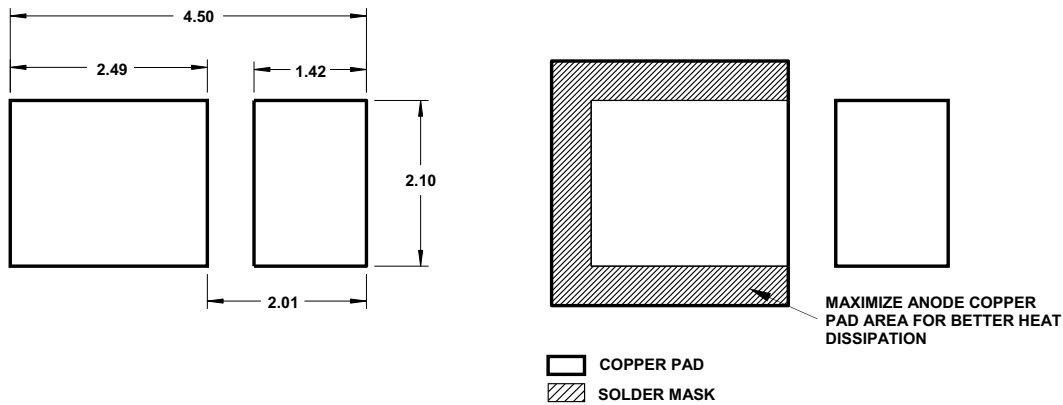
**Figure 18: Maximum Forward Current vs. Ambient Temperature. Derated based on  $T_{JMAX} = 125^\circ\text{C}$**



**Figure 19: Maximum Forward Current vs. Solder Point Temperature. Derated based on  $T_{JMAX} = 125^\circ\text{C}$ ,  $R_{\theta J-S} = 20^\circ\text{C/W}$**

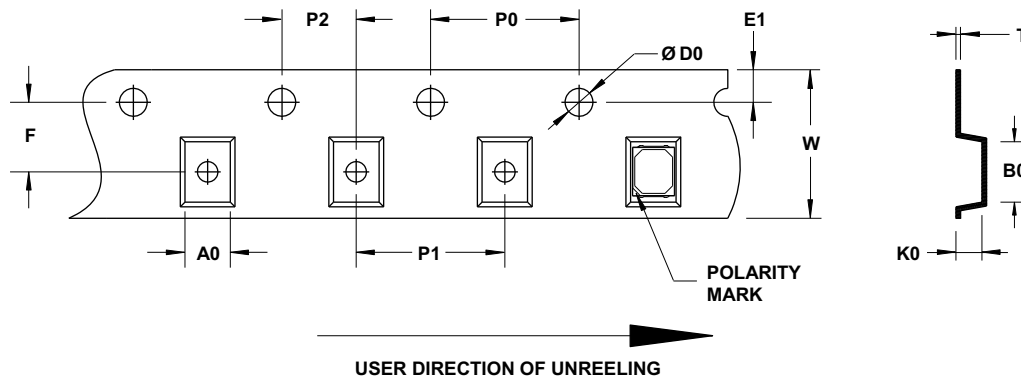


**Figure 20: Recommended Soldering Land Pattern**



**NOTE:** All dimensions are in millimeters (mm).

**Figure 21: Carrier Tape Dimensions**

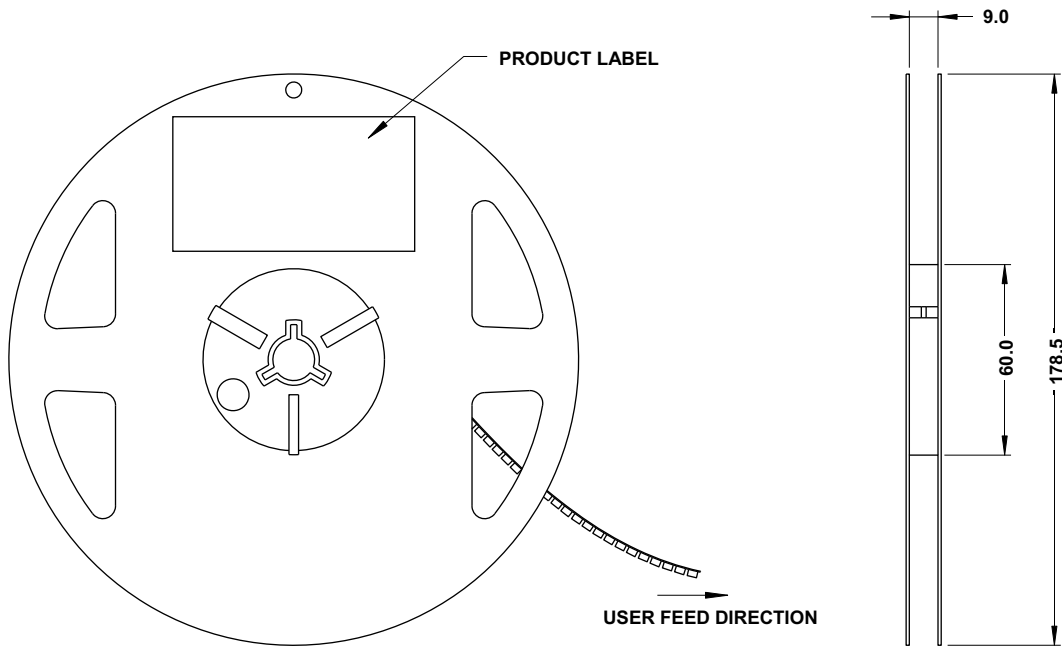


<b>F</b>	<b>P0</b>	<b>P1</b>	<b>P2</b>	<b>D0</b>	<b>E1</b>	<b>W</b>
3.5 ± 0.05	4.0 ± 0.1	4.0 ± 0.1	2.0 ± 0.05	1.55 ± 0.05	1.75 ± 0.1	8.0 ± 0.2
<b>T</b>	<b>B0</b>	<b>K0</b>	<b>A0</b>			
0.2 ± 0.05	3.8 ± 0.1	1.05 ± 0.1	3.1 ± 0.1			

**NOTE:**

1. All dimensions are in millimeters (mm).
2. Tolerance is ± 0.20 mm unless otherwise specified.

**Figure 22: Reel Dimensions**



**NOTE:** All dimensions are in millimeters (mm).

# Precautionary Notes

## Soldering

- Do not perform reflow soldering more than twice. Observe necessary precautions of handling moisture-sensitive devices as stated in the following section.
- Do not apply any pressure or force on the LED during reflow and after reflow when the LED is still hot.
- Use reflow soldering to solder the LED. Use hand soldering only for rework if unavoidable, but it must be strictly controlled to following conditions:
  - Soldering iron tip temperature = 315°C maximum
  - Soldering duration = 3 seconds maximum
  - Number of cycles = 1 only
  - Power of soldering iron = 50W maximum
- Do not touch the LED package body with the soldering iron except for the soldering terminals, as it may cause damage to the LED.
- Confirm beforehand whether the functionality and performance of the LED is affected by soldering with hand soldering.

Figure 23: Recommended Lead-Free Reflow Soldering Profile

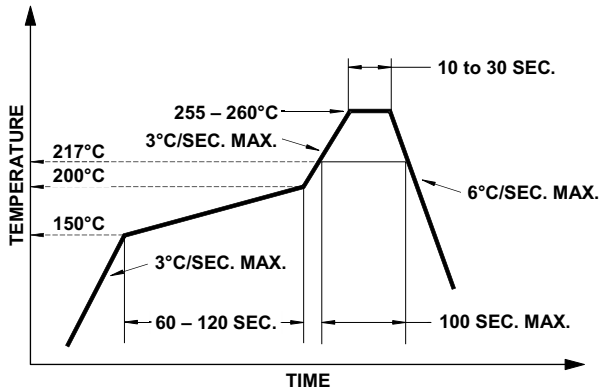
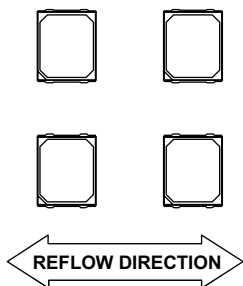


Figure 24: Recommended Board Reflow Direction



## Handling Precautions

The encapsulation material of the LED is made of silicone for better product reliability. Compared to epoxy encapsulant, which is hard and brittle, silicone is softer and flexible. Observe special handling precautions during assembly of silicone encapsulated LED products. Failure to comply might lead to damage and premature failure of the LED. Refer to Broadcom Application Note AN5288, *Silicone Encapsulation for LED: Advantages and Handling Precautions*, for additional information.

- Do not poke sharp objects into the silicone encapsulant. Sharp objects, such as tweezers or syringes, might apply excessive force or even pierce through the silicone and induce failures to the LED die or wire bond.
- Do not touch the silicone encapsulant. Uncontrolled force acting on the silicone encapsulant might result in excessive stress on the wire bond. Hold the LED only by the body.
- Do not stack assembled PCBs together. Use an appropriate rack to hold the PCBs.
- The surface of the silicone material attracts dust and dirt easier than epoxy due to its surface tackiness. To remove foreign particles on the surface of silicone, use a cotton bud with isopropyl alcohol (IPA). During cleaning, rub the surface gently without putting too much pressure on the silicone. Ultrasonic cleaning is not recommended.
- For automated pick and place, Broadcom has tested a nozzle size with OD 3.5 mm to work with this LED. However, due to the possibility of variations in other parameters such as pick and place machine maker/model, and other settings of the machine, verify that the selected nozzle will not cause damage to the LED.

## Handling of Moisture-Sensitive Devices

This product has a Moisture Sensitive Level 3 rating per JEDEC J-STD-020. Refer to Broadcom Application Note AN5305, *Handling of Moisture Sensitive Surface Mount Devices*, for additional details and a review of proper handling procedures.

**Before use:**

- An unopened moisture barrier bag (MBB) can be stored at <math>40^{\circ}\text{C}/90\% \text{ RH}</math> for 12 months. If the actual shelf life has exceeded 12 months and the humidity indicator card (HIC) indicates that baking is not required, then it is safe to reflow the LEDs per the original MSL rating.
- Do not open the MBB prior to assembly (for example, for IQC). If unavoidable, the MBB must be properly resealed with fresh desiccant and HIC. The exposed duration must be taken in as floor life.

**Control after opening the MBB:**

- Read the HIC immediately upon opening of MBB.
- Keep the LEDs at <math>30^{\circ}/60\% \text{ RH}</math> at all times, and complete all high temperature-related processes, including soldering, curing, or rework within 168 hours.

**Control for unfinished reel:**

Store unused LEDs in a sealed MBB with desiccant or a desiccator at <math>5\% \text{ RH}</math>.

**Control of assembled boards:**

If the PCB soldered with the LEDs is to be subjected to other high-temperature processes, store the PCB in a sealed MBB with desiccant or desiccator at <math>5\% \text{ RH}</math> to ensure that all LEDs have not exceeded their floor life of 168 hours.

**Baking is required if the following conditions exist:**

- The HIC indicator indicates a change in color for 10% and 5%, as stated on the HIC.
- The LEDs are exposed to conditions of <math>30^{\circ}\text{C}/60\% \text{ RH}</math> at any time.
- The LED's floor life exceeded 168 hours.

The recommended baking condition is: <math>60^{\circ}\text{C} \pm 5^{\circ}\text{C}</math> for 20 hours.

Baking can only be done once.

**Storage:**

The soldering terminals of these Broadcom LEDs are silver plated. If the LEDs are exposed in an ambient environment for too long, the silver plating might be oxidized, thus affecting its solderability performance. As such, keep unused LEDs in a sealed MBB with desiccant or in a desiccator at <math>5\% \text{ RH}</math>.

**Application Precautions**

- The drive current of the LED must not exceed the maximum allowable limit across temperature as stated in the data sheet. Constant current driving is recommended to ensure consistent performance.
- Circuit design must cater to the whole range of forward voltage ( $V_F$ ) of the LEDs to ensure the intended drive current can always be achieved.
- The LED exhibits slightly different characteristics at different drive currents, which may result in a larger variation of performance (such as intensity, wavelength, and forward voltage). Set the application current as close as possible to the test current to minimize these variations.
- Do not use the LED in the vicinity of material with sulfur content or in environments of high gaseous sulfur compounds and corrosive elements. Examples of material that might contain sulfur are rubber gaskets, room-temperature vulcanizing (RTV) silicone rubber, rubber gloves, and so on. Prolonged exposure to such environments may affect the optical characteristics and product life.
- White LEDs must not be exposed to acidic environments and must not be used in the vicinity of any compound that may have acidic outgas, such as, but not limited to, acrylate adhesive. These environments have an adverse effect on LED performance.
- Avoid rapid changes in ambient temperature, especially in high-humidity environments, because they cause condensation on the LED.
- If the LED is intended to be used in a harsh or an outdoor environment, protect the LED against damages caused by rain water, water, dust, oil, corrosive gases, external mechanical stresses, and so on.

## Thermal Management

The optical, electrical, and reliability characteristics of the LED are affected by temperature. Keep the junction temperature ( $T_J$ ) of the LED below the allowable limit at all times.  $T_J$  can be calculated as follows:

$$T_J = T_A + R_{\theta J-A} \times I_F \times V_{Fmax}$$

where:

$T_A$  = Ambient temperature ( $^{\circ}\text{C}$ )

$R_{\theta J-A}$  = Thermal resistance from LED junction to ambient ( $^{\circ}\text{C}/\text{W}$ )

$I_F$  = Forward current (A)

$V_{Fmax}$  = Maximum forward voltage (V)

The complication of using this formula lies in  $T_A$  and  $R_{\theta J-A}$ . Actual  $T_A$  is sometimes subjective and hard to determine.  $R_{\theta J-A}$  varies from system to system depending on design and is usually not known.

Another way of calculating  $T_J$  is by using the solder point temperature,  $T_S$  as follows:

$$T_J = T_S + R_{\theta J-S} \times I_F \times V_{Fmax}$$

where:

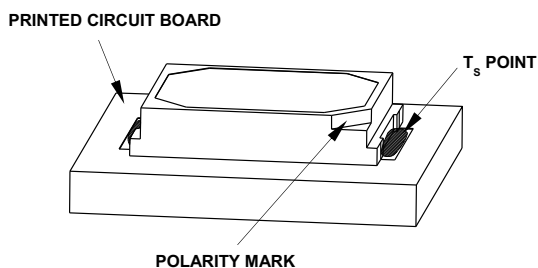
$T_S$  = LED solder point temperature as shown in the following figure ( $^{\circ}\text{C}$ )

$R_{\theta J-S}$  = Thermal resistance from junction to solder point ( $^{\circ}\text{C}/\text{W}$ )

$I_F$  = Forward current (A)

$V_{Fmax}$  = Maximum forward voltage (V)

**Figure 25: Solder Point Temperature on PCB**



$T_S$  can be easily measured by mounting a thermocouple on the soldering joint as shown in preceding figure, while  $R_{\theta J-S}$  is provided in the data sheet. Verify the  $T_S$  of the LED in the final product to ensure that the LEDs are operating within all maximum ratings stated in the data sheet.

## Eye Safety Precautions

LEDs may pose optical hazards when in operation. Do not look directly at operating LEDs because it might be harmful to the eyes. For safety reasons, use appropriate shielding or personal protective equipment.

## Disclaimer

Broadcom's products and software are not specifically designed, manufactured, or authorized for sale as parts, components, or assemblies for the planning, construction, maintenance, or direct operation of a nuclear facility or for use in medical devices or applications. The customer is solely responsible, and waives all rights to make claims against Broadcom or its suppliers, for all loss, damage, expense, or liability in connection with such use.

Broadcom, the pulse logo, Connecting everything, Avago Technologies, Avago, and the A logo are among the trademarks of Broadcom and/or its affiliates in the United States, certain other countries, and/or the EU.

Copyright © 2020 Broadcom. All Rights Reserved.

The term "Broadcom" refers to Broadcom Inc. and/or its subsidiaries. For more information, please visit [www.broadcom.com](http://www.broadcom.com).

Broadcom reserves the right to make changes without further notice to any products or data herein to improve reliability, function, or design. Information furnished by Broadcom is believed to be accurate and reliable. However, Broadcom does not assume any liability arising out of the application or use of this information, nor the application or use of any product or circuit described herein, neither does it convey any license under its patent rights nor the rights of others.

