

E3M0032120K

Silicon Carbide Power MOSFET
E-Series Automotive
N-Channel Enhancement Mode



Features

- 3rd generation SiC MOSFET technology
- Optimized package with separate driver source pin
- 8mm of creepage distance between drain and source
- High blocking voltage with low on-resistance
- High-speed switching with low capacitances
- Fast intrinsic diode with low reverse recovery (Q_{rr})
- Halogen free, RoHS compliant
- Automotive Qualified (AEC-Q101) and PPAP Capable

Benefits

- Reduce switching losses and minimize gate ringing
- Higher system efficiency
- Reduce cooling requirements
- Increase power density
- Increase system switching frequency

Applications

- Motor Control
- EV Battery Chargers
- High Voltage DC/DC Converters

Package

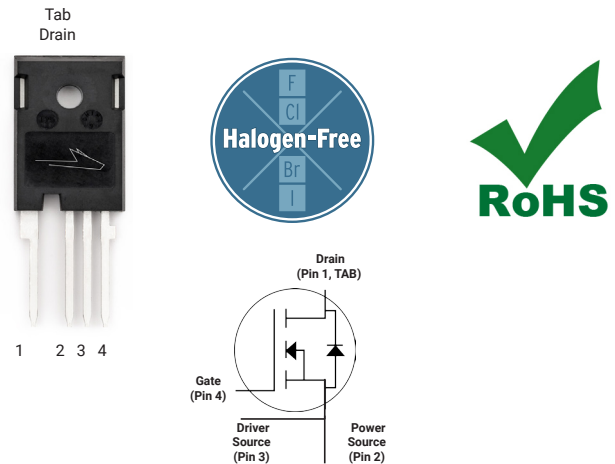

Part Number	Package	Marking
E3M0032120K	TO-247-4L	E3M0032120K

Maximum Ratings ($T_c = 25^\circ\text{C}$ unless otherwise specified)

Symbol	Parameter	Value	Unit	Note	
V_{DSmax}	Drain - Source Voltage	1200	V		
V_{GSmax}	Gate - Source Voltage	-8/+19	V	Note: 1	
I_D	Continuous Drain Current, $V_{GS} = 15\text{ V}$	$T_c = 25^\circ\text{C}$	67	A	Fig. 19 Note: 2
		$T_c = 100^\circ\text{C}$	48		
$I_{D(pulse)}$	Pulsed Drain Current, Pulse width t_p limited by T_{jmax}	156	A	Fig. 22	
P_D	Power Dissipation, $T_c=25^\circ\text{C}$, $T_j = 175^\circ\text{C}$	278	W	Fig. 20 Note: 2	
T_j, T_{stg}	Operating Junction and Storage Temperature	-55 to +175	$^\circ\text{C}$		
T_L	Solder Temperature, 1.6mm (0.063") from case for 10s	260	$^\circ\text{C}$		
M_d	Mounting Torque, M3 or 6-32 screw	1	Nm lbf-in		
		8.8			

Note (1): Recommended turn off / turn on gate voltage $V_{GS} = -4V...0V / +15V$

Note (2): Verified by design

Electrical Characteristics ($T_C = 25^\circ\text{C}$ unless otherwise specified)

Symbol	Parameter	Min.	Typ.	Max.	Unit	Test Conditions	Note
$V_{(BR)DSS}$	Drain-Source Breakdown Voltage	1200			V	$V_{GS} = 0\text{ V}, I_D = 100\ \mu\text{A}$	
$V_{GS(th)}$	Gate Threshold Voltage	1.8	2.9	3.6	V	$V_{DS} = V_{GS}, I_D = 10.7\ \text{mA}$	Fig. 11
			2.4		V	$V_{DS} = V_{GS}, I_D = 10.7\ \text{mA}, T_J = 175^\circ\text{C}$	
I_{DSS}	Zero Gate Voltage Drain Current		1	50	μA	$V_{DS} = 1200\ \text{V}, V_{GS} = 0\ \text{V}$	
I_{GSS}	Gate-Source Leakage Current		10	250	nA	$V_{GS} = 15\ \text{V}, V_{DS} = 0\ \text{V}$	
$R_{DS(on)}$	Drain-Source On-State Resistance		32	43	m Ω	$V_{GS} = 15\ \text{V}, I_D = 38.9\ \text{A}$	Fig. 4, 5, 6
			55			$V_{GS} = 15\ \text{V}, I_D = 38.9\ \text{A}, T_J = 175^\circ\text{C}$	
g_{fs}	Transconductance		23		S	$V_{DS} = 20\ \text{V}, I_{DS} = 38.9\ \text{A}$	Fig. 7
			22			$V_{DS} = 20\ \text{V}, I_{DS} = 38.9\ \text{A}, T_J = 175^\circ\text{C}$	
C_{iss}	Input Capacitance		3460		pF	$V_{GS} = 0\ \text{V}, V_{DS} = 0\ \text{V to } 1000\ \text{V}$ $F = 100\ \text{kHz}$ $V_{AC} = 25\ \text{mV}$	Fig. 17, 18
C_{oss}	Output Capacitance		126				
C_{rss}	Reverse Transfer Capacitance		7				
E_{oss}	C_{oss} Stored Energy		71		μJ		Fig. 16
$C_{o(er)}$	Effective Output Capacitance (Energy Related)		158		pF	$V_{GS} = 0\ \text{V}, V_{DS} = 0... 800\ \text{V}$	Note: 3
$C_{o(tr)}$	Effective Output Capacitance (Time Related)		242		pF		
E_{oN}	Turn-On Switching Energy (External Diode)		387		μJ	$V_{DS} = 800\ \text{V}, V_{GS} = -4\ \text{V}/15\ \text{V}, I_D = 38.9\ \text{A},$ $R_{G(ext)} = 2.5\ \Omega, L = 99\ \mu\text{H}, T_J = 175^\circ\text{C}$ FWD = External SiC DIODE	Fig. 26, 28
E_{oOFF}	Turn Off Switching Energy (External Diode)		91				
E_{oN}	Turn-On Switching Energy (Body Diode FWD)		791		μJ	$V_{DS} = 800\ \text{V}, V_{GS} = -4\ \text{V}/15\ \text{V}, I_D = 38.9\ \text{A},$ $R_{G(ext)} = 2.5\ \Omega, L = 99\ \mu\text{H}, T_J = 175^\circ\text{C}$ FWD = Internal Body Diode	Fig. 26, 28
E_{oOFF}	Turn-Off Switching Energy (Body Diode FWD)		103				
$t_{d(on)}$	Turn-On Delay Time		16		ns	$V_{DD} = 800\ \text{V}, V_{GS} = -4\ \text{V}/15\ \text{V}$ $I_D = 38.9\ \text{A}, R_{G(ext)} = 2.5\ \Omega,$ Timing relative to V_{DS} Inductive load	Fig. 27, 28
t_r	Rise Time		19				
$t_{d(off)}$	Turn-Off Delay Time		24				
t_f	Fall Time		8				
$R_{G(int)}$	Internal Gate Resistance		1.9		Ω	$f = 1\ \text{MHz}, V_{AC} = 25\ \text{mV}$	
Q_{gs}	Gate to Source Charge		41		nC	$V_{DS} = 800\ \text{V}, V_{GS} = -4\ \text{V}/15\ \text{V}$ $I_D = 38.9\ \text{A}$ Per IEC60747-8-4 pg 21	Fig. 12
Q_{gd}	Gate to Drain Charge		31				
Q_g	Total Gate Charge		113				

Note (3): $C_{o(er)}$, a lumped capacitance that gives same stored energy as C_{oss} while V_{ds} is rising from 0 to 800V
 $C_{o(tr)}$, a lumped capacitance that gives same charging time as C_{oss} while V_{ds} is rising from 0 to 800V

Reverse Diode Characteristics ($T_c = 25^\circ\text{C}$ unless otherwise specified)

Symbol	Parameter	Typ.	Max.	Unit	Test Conditions	Note
V_{SD}	Diode Forward Voltage	4.9		V	$V_{GS} = -4\text{ V}, I_{SD} = 20\text{ A}, T_J = 25^\circ\text{C}$	Fig. 8, 9, 10
		4.3		V	$V_{GS} = -4\text{ V}, I_{SD} = 20\text{ A}, T_J = 175^\circ\text{C}$	
I_S	Continuous Diode Forward Current		50	A	$V_{GS} = -4\text{ V}, T_c = 25^\circ\text{C}$	
$I_{S, pulse}$	Diode pulse Current		156	A	$V_{GS} = -4\text{ V}$, pulse width t_p limited by T_{jmax}	
t_{rr}	Reverse Recover time	20		ns	$V_{GS} = -4\text{ V}, I_{SD} = 38.9\text{ A}, V_R = 800\text{ V}$ $dif/dt = 7460\text{ A}/\mu\text{s}, T_J = 175^\circ\text{C}$	
Q_{rr}	Reverse Recovery Charge	894		nC		
I_{rrm}	Peak Reverse Recovery Current	75		A		
t_{rr}	Reverse Recover time	37		ns	$V_{GS} = -4\text{ V}, I_{SD} = 38.9\text{ A}, V_R = 800\text{ V}$ $dif/dt = 1780\text{ A}/\mu\text{s}, T_J = 175^\circ\text{C}$	
Q_{rr}	Reverse Recovery Charge	680		nC		
I_{rrm}	Peak Reverse Recovery Current	28		A		

Thermal Characteristics

Symbol	Parameter	Typ.	Max.	Unit	Test Conditions	Note
$R_{\theta JC}$	Thermal Resistance from Junction to Case	0.44	0.54	$^\circ\text{C}/\text{W}$		Fig. 21



Typical Performance

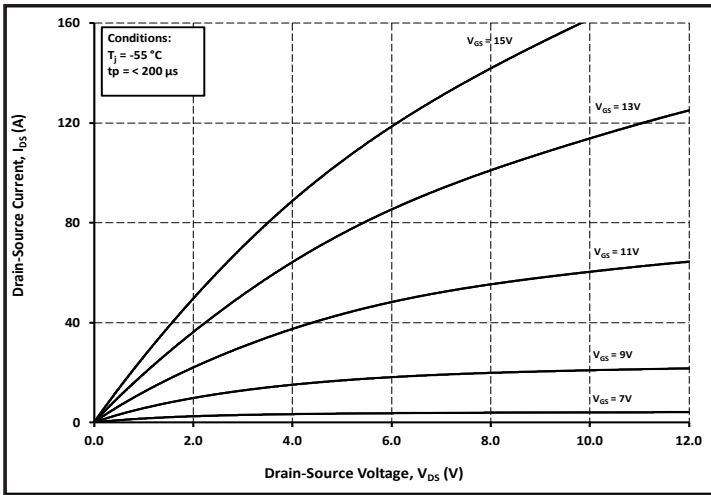

Figure 1. Output Characteristics $T_J = -55\text{ }^\circ\text{C}$

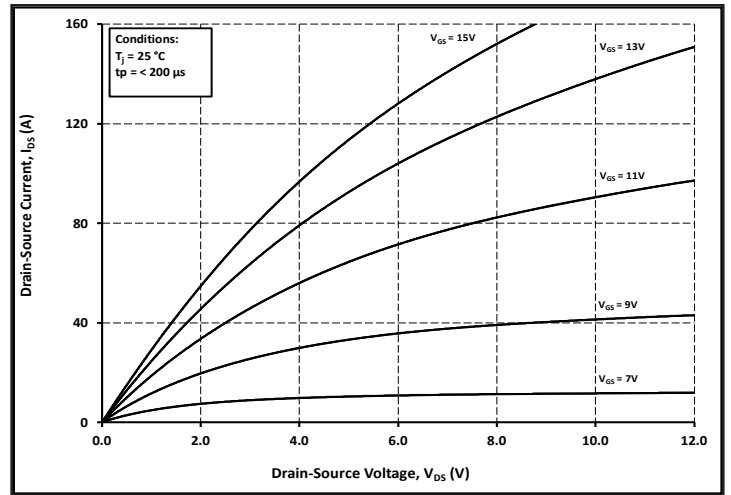

Figure 2. Output Characteristics $T_J = 25\text{ }^\circ\text{C}$

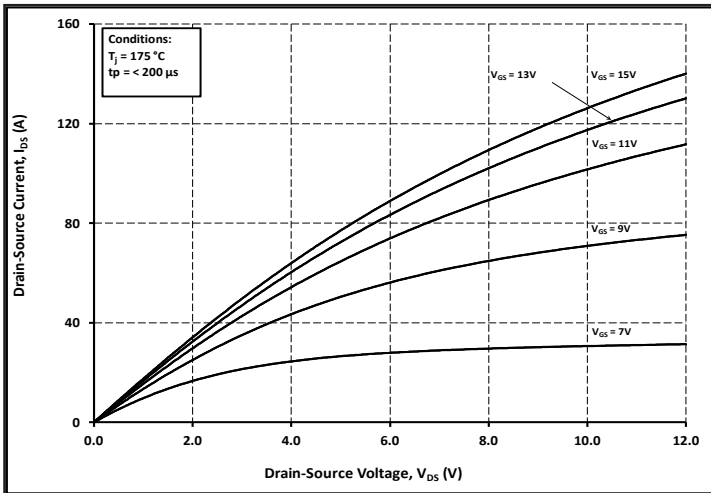

Figure 3. Output Characteristics $T_J = 175\text{ }^\circ\text{C}$

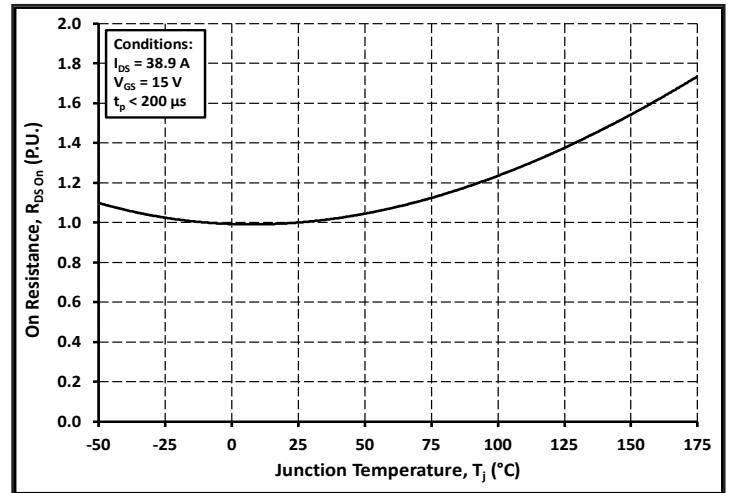

Figure 4. Normalized On-Resistance vs. Temperature

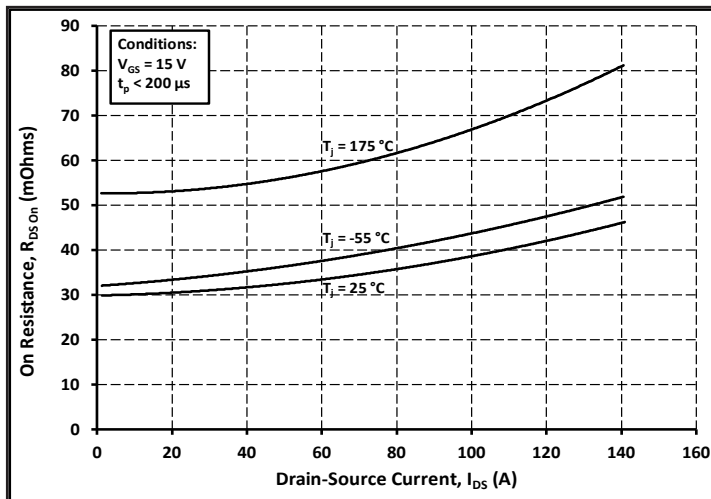

Figure 5. On-Resistance vs. Drain Current For Various Temperatures

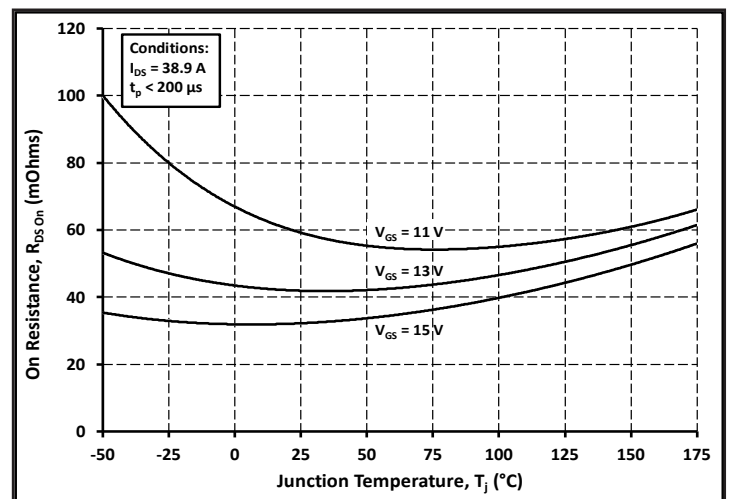

Figure 6. On-Resistance vs. Temperature For Various Gate Voltage

Typical Performance

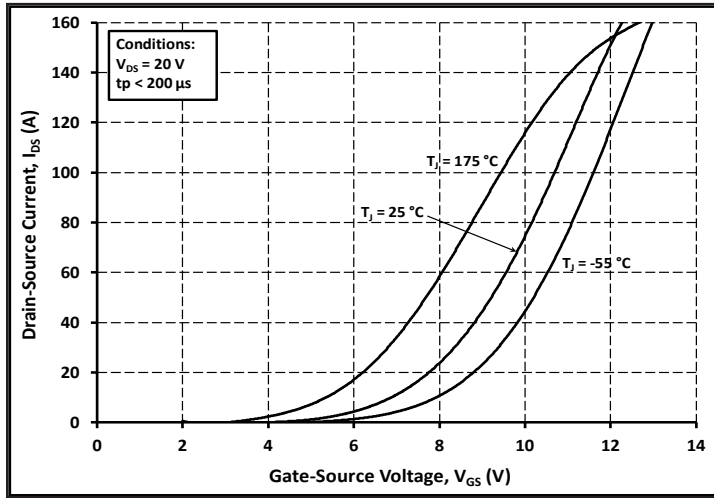

Figure 7. Transfer Characteristic for Various Junction Temperatures

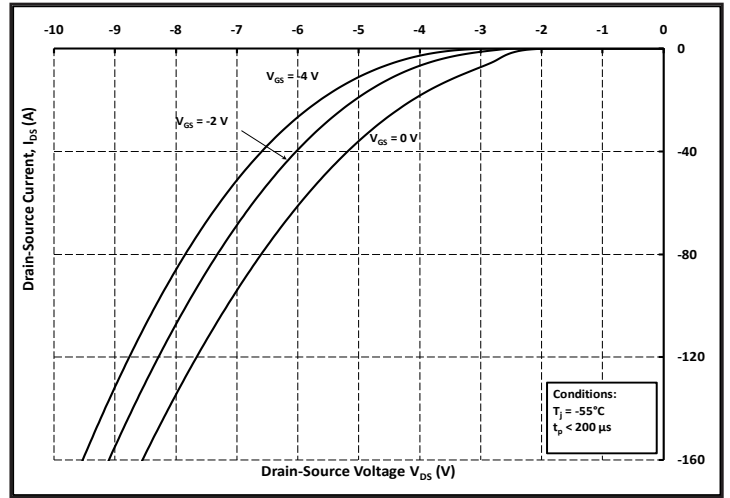

Figure 8. Body Diode Characteristic at -55 °C

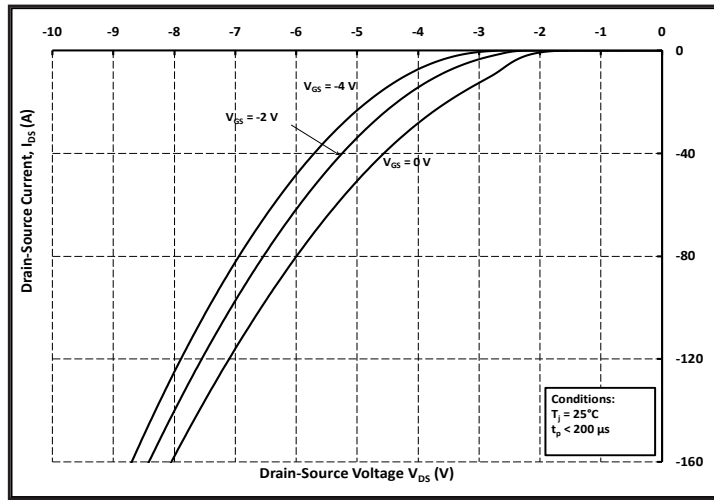

Figure 9. Body Diode Characteristic at 25 °C

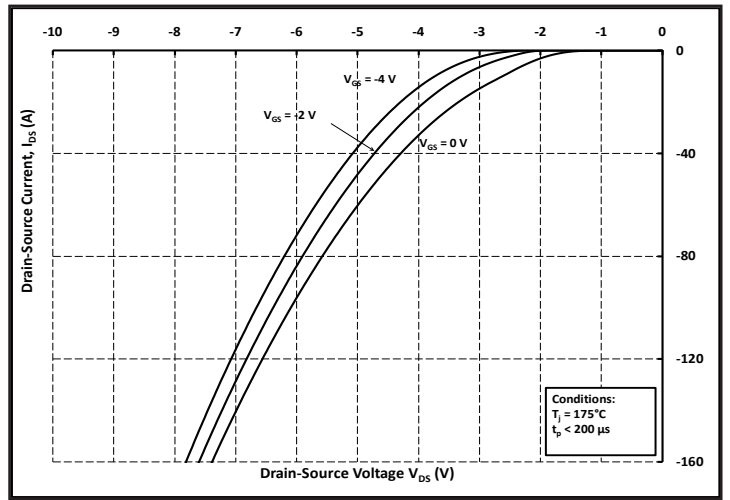

Figure 10. Body Diode Characteristic at 175 °C

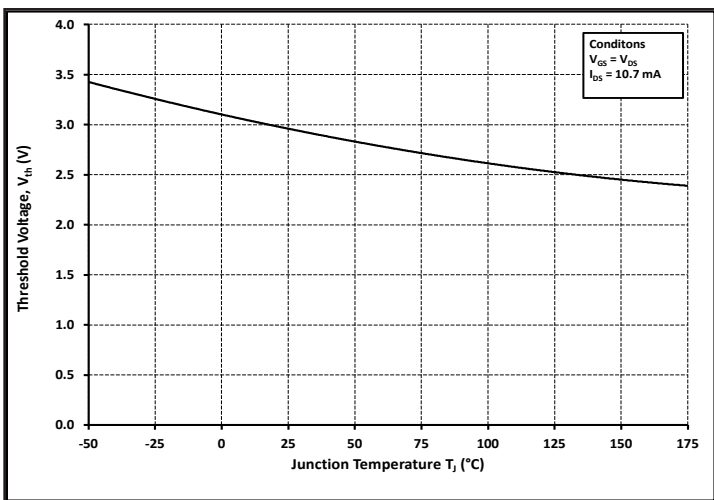

Figure 11. Threshold Voltage vs. Temperature

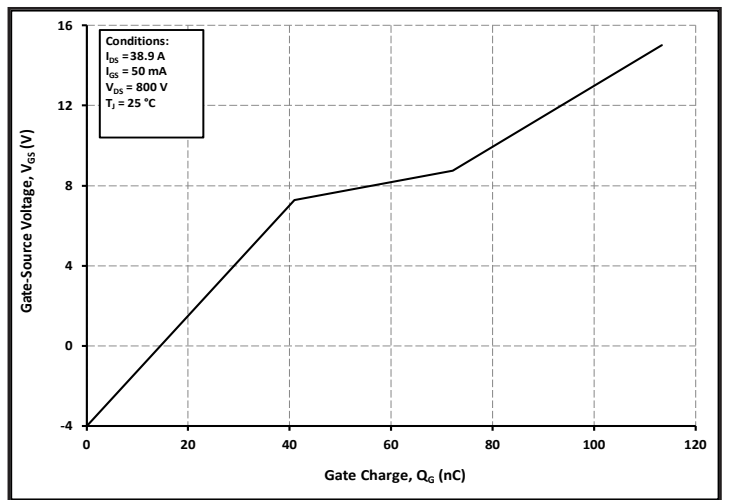

Figure 12. Gate Charge Characteristics



Typical Performance

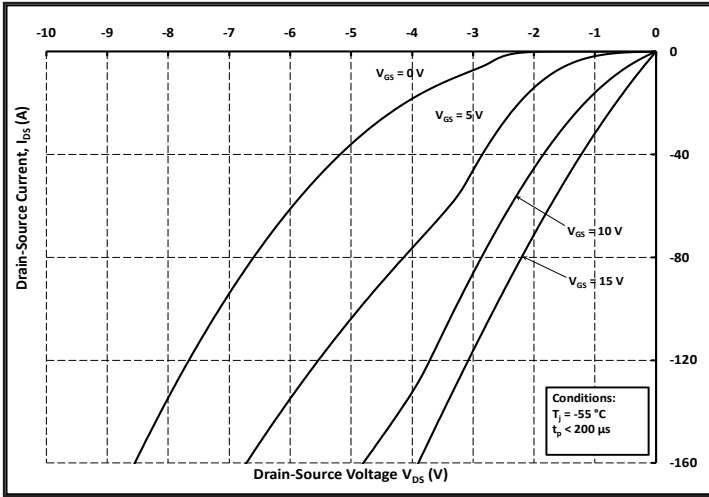

Figure 13. 3rd Quadrant Characteristic at -55 °C

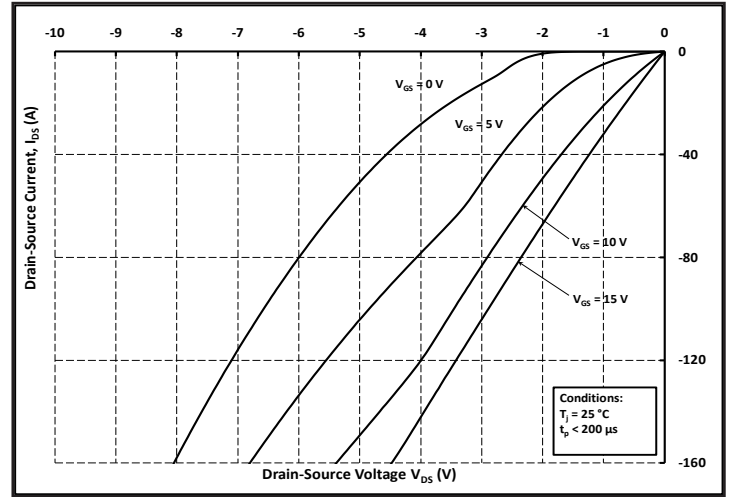

Figure 14. 3rd Quadrant Characteristic at 25 °C

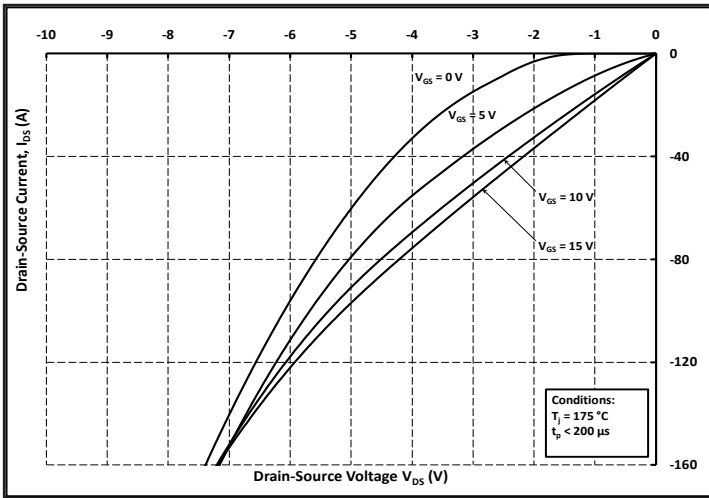

Figure 15. 3rd Quadrant Characteristic at 175 °C

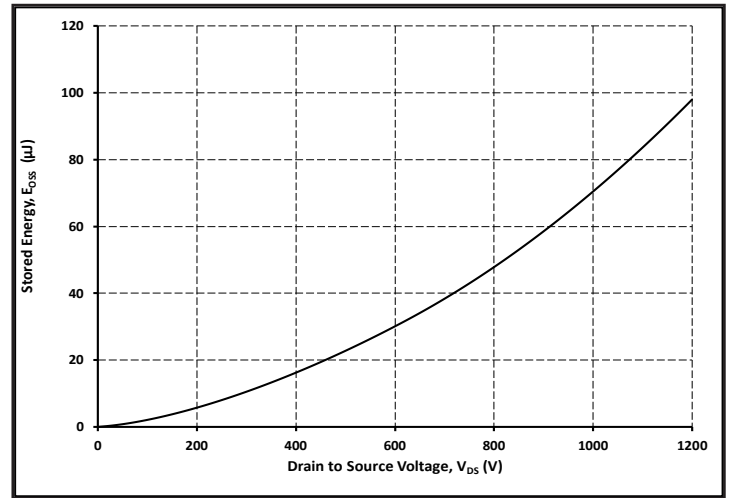

Figure 16. Output Capacitor Stored Energy

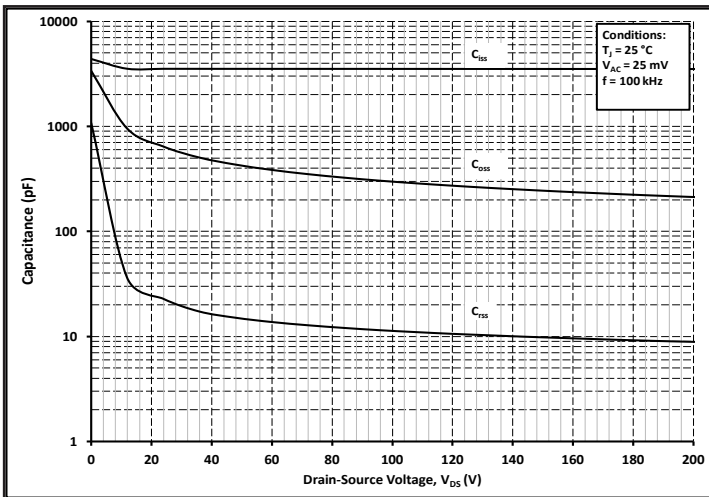

Figure 17. Capacitances vs. Drain-Source Voltage (0 - 200V)

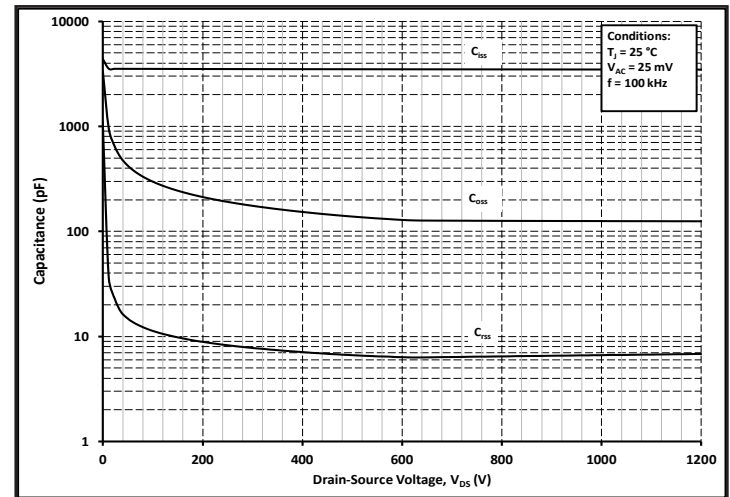

Figure 18. Capacitances vs. Drain-Source Voltage (0 - 1200V)



Typical Performance

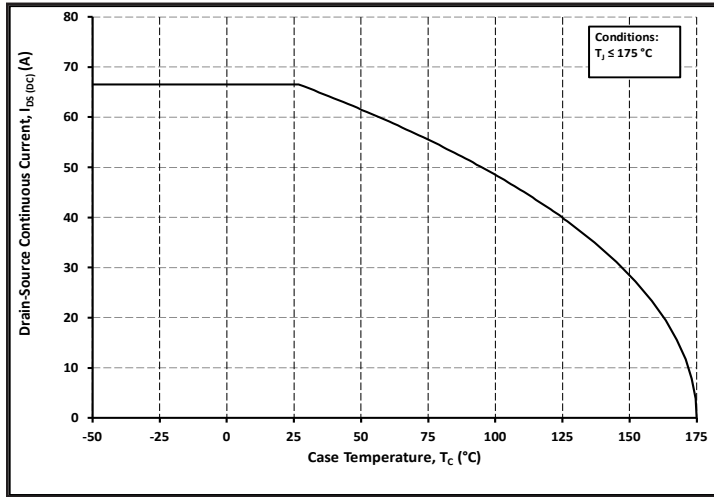

Figure 19. Continuous Drain Current Derating vs. Case Temperature

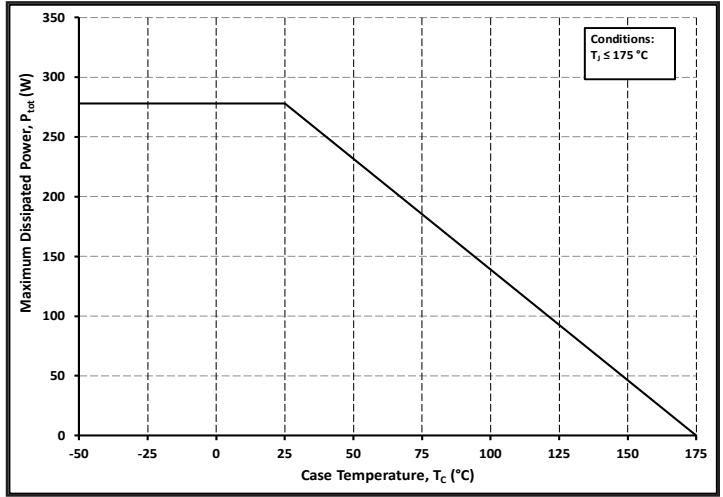

Figure 20. Maximum Power Dissipation Derating vs. Case Temperature

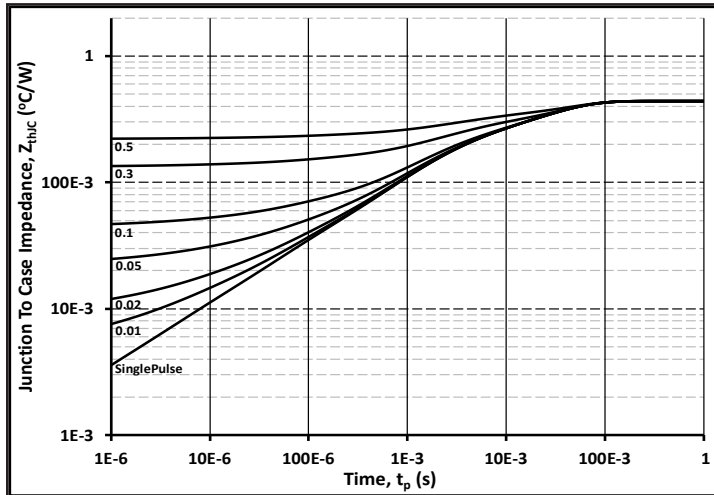

Figure 21. Transient Thermal Impedance (Junction - Case)

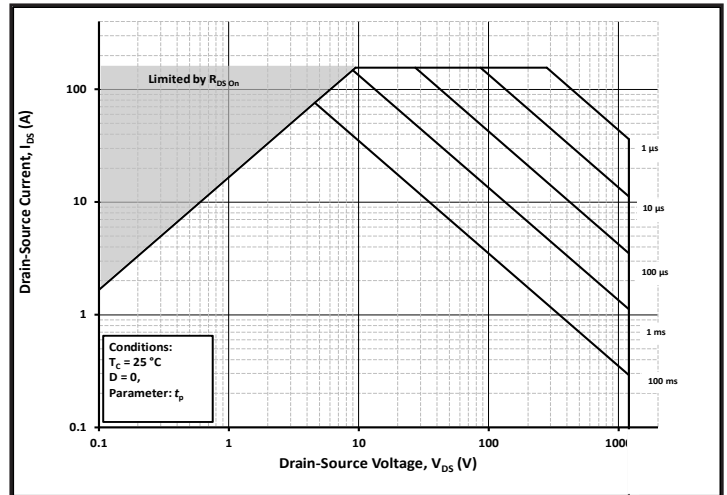

Figure 22. Safe Operating Area

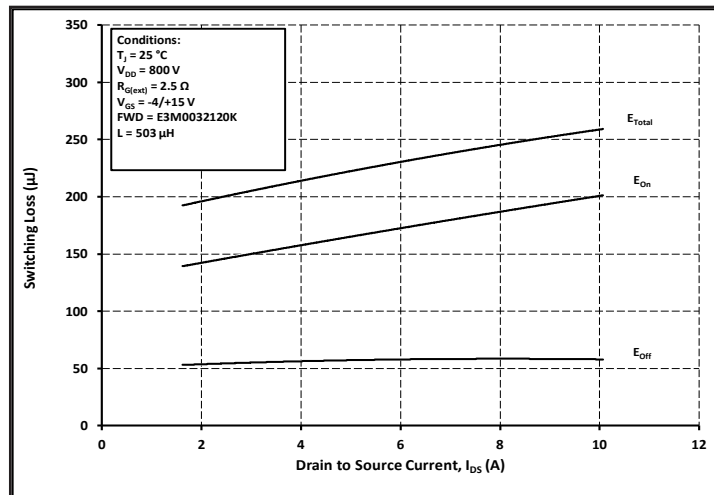

Figure 23. Clamped Inductive Switching Energy vs. Low Drain Current ($V_{DD} = 800V$)

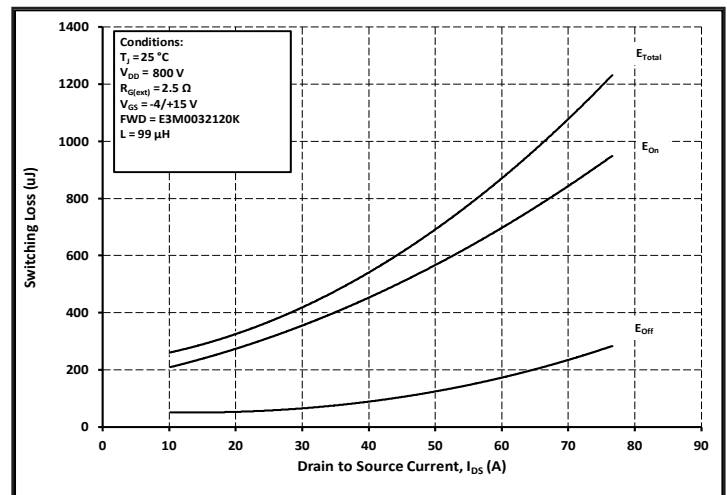

Figure 24. Clamped Inductive Switching Energy vs. High Drain Current ($V_{DD} = 800V$)

Typical Performance

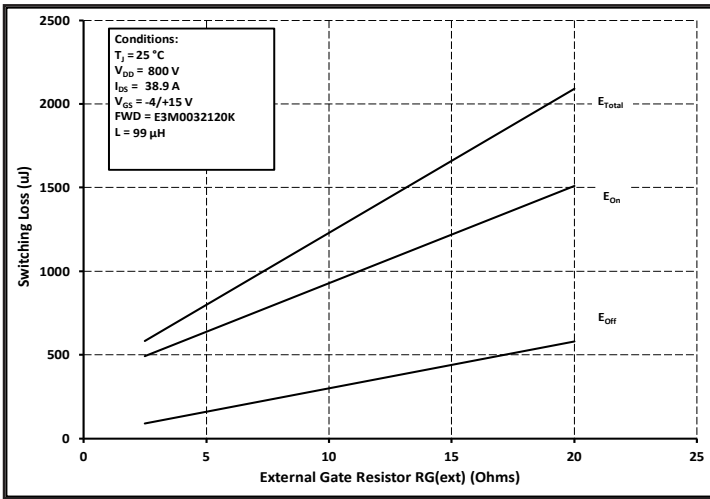

Figure 25. Clamped Inductive Switching Energy vs. $R_{G(ext)}$

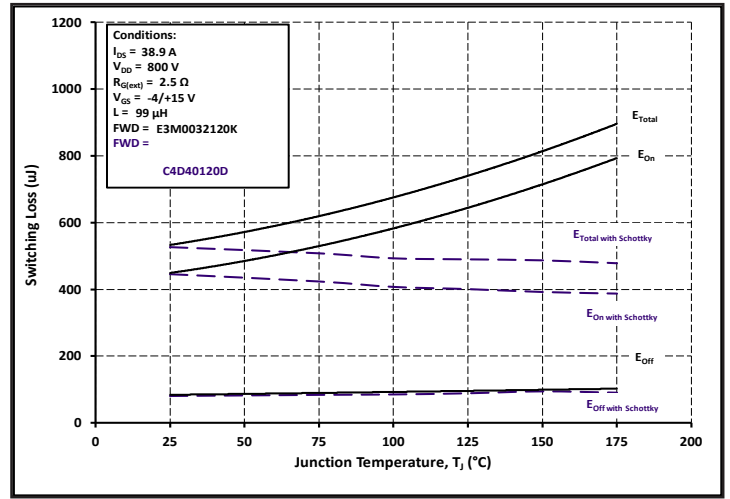

Figure 26. Clamped Inductive Switching Energy vs. Temperature

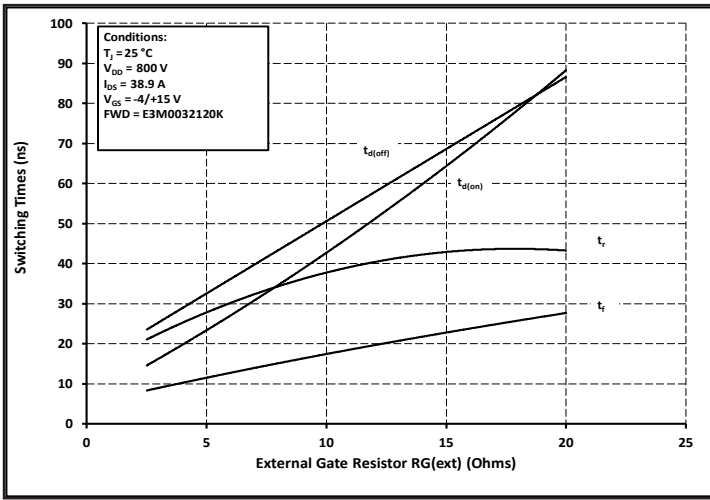

Figure 27. Switching Times vs. $R_{G(ext)}$

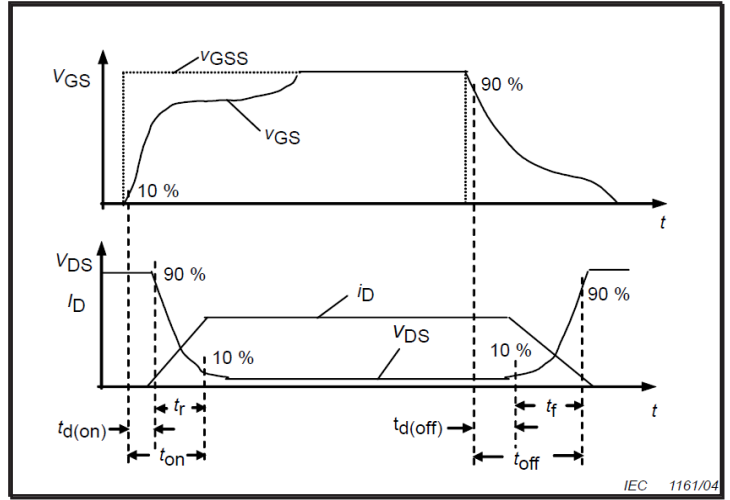

Figure 28. Switching Times Definition

Test Circuit Schematic

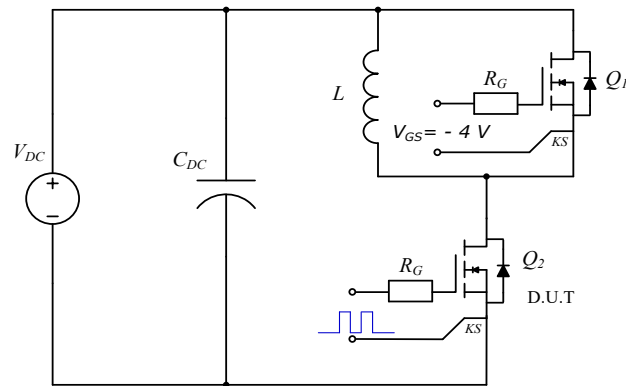
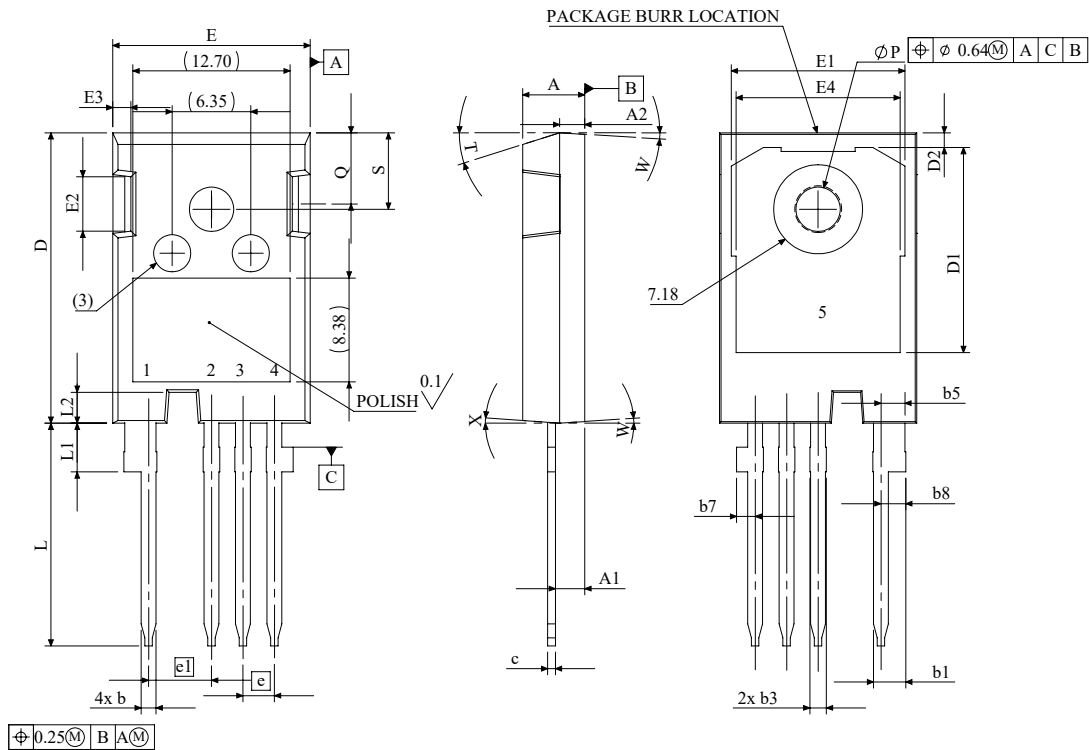

Figure 29. Clamped Inductive Switching Waveform Test Circuit

Package Dimensions



⌀ 0.25(M) B A(M)

SYMBOL	MIN (mm)	MAX (mm)
A	4.83	5.21
A1	2.29	2.54
A2	1.91	2.16
b	1.07	1.33
b1	2.39	2.94
b3	1.07	1.60
b5	2.39	2.69
b7	1.30	1.70
b8	1.80	2.20
c	0.55	0.68
D	23.30	23.60
D1	16.25	17.65
D2	0.95	1.25
E	15.75	16.13
E1	13.1	14.15
E2	3.68	5.10
E3	1.00	1.90
E4	12.38	13.43
e	2.54 BSC	
e1	5.08 BSC	
L	17.31	17.82
L1	3.97	4.37
L2	2.35	2.65
⌀P	3.51	3.65
Q	5.49	6.00
S	6.04	6.30
T	17.5° REF.	
W	3.5° REF.	
X	4° REF.	

1	DRAIN
2	SOURCE
3	DRIVER SOURCE
4	GATE
5	DRAIN

NOTE:

1. ALL METAL SURFACES ARE TIN PLATED (MATTE), EXCEPT AREA OF CUT.
2. DIMENSIONING & TOLERANCING CONFORM TO ASME Y14.5M-1994.
3. ALL DIMENSIONS ARE LISTED IN MILLIMETERS. ANGLES ARE IN DEGREES.
4. BURR OR MOLD FLASH SIZE (0.5 mm) IS NOT INCLUDED IN THE DIMENSIONS



Recommended Solder Pad Layout

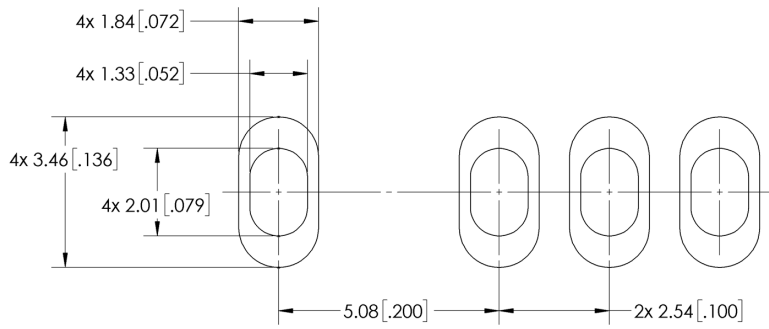



Revision history

Document Version	Date of release	Description of changes
1.0	June-2022	Initial Datasheet
2.0	October-2022	Commercial Release



Notes & Disclaimer

This document and the information contained herein are subject to change without notice. Any such change shall be evidenced by the publication of an updated version of this document by Wolfspeed. No communication from any employee or agent of Wolfspeed or any third party shall effect an amendment or modification of this document. No responsibility is assumed by Wolfspeed for any infringement of patents or other rights of third parties which may result from use of the information contained herein. No license is granted by implication or otherwise under any patent or patent rights of Wolfspeed.

Notwithstanding any application-specific information, guidance, assistance, or support that Wolfspeed may provide, the buyer of this product is solely responsible for determining the suitability of this product for the buyer's purposes, including without limitation for use in the applications identified in the next bullet point, and for the compliance of the buyers' products, including those that incorporate this product, with all applicable legal, regulatory, and safety-related requirements.

This product has not been designed or tested for use in, and is not intended for use in, applications in which failure of the product would reasonably be expected to cause death, personal injury, or property damage, including but not limited to equipment implanted into the human body, life-support machines, cardiac defibrillators, and similar emergency medical equipment, aircraft navigation, communication, and control systems, aircraft power and propulsion systems, air traffic control systems, and equipment used in the planning, construction, maintenance, or operation of nuclear facilities.

RoHS Compliance

The levels of RoHS restricted materials in this product are below the maximum concentration values (also referred to as the threshold limits) permitted for such substances, or are used in an exempted application, in accordance with EU Directive 2011/65/EC (RoHS2), as implemented January 2, 2013. RoHS Declarations for this product can be obtained from your Wolfspeed representative or from the Product Documentation sections of www.wolfspeed.com.

REACH Compliance

REACH substances of high concern (SVHCs) information is available for this product. Since the European Chemical Agency (ECHA) has published notice of their intent to frequently revise the SVHC listing for the foreseeable future, please contact your Wolfspeed representative to ensure you get the most up-to-date REACH SVHC Declaration. REACH banned substance information (REACH Article 67) is also available upon request.

Contact info:

4600 Silicon Drive
Durham, NC 27703 USA
Tel: +1.919.313.5300
www.wolfspeed.com/power