

Overview

Multilayer, metallized paper encapsulated and impregnated in self-extinguishing material that meets the requirements of UL 94 V-0.

Applications

Typical applications include interference suppressors with X2 + 2x Y2 capacitors in a delta configuration.

Benefits

- Approvals: ENEC, UL, cUL
- Rated Voltage: 275 VAC 50/60 Hz
- Capacitance X Value: 0.1 μ F, and 0.15 μ F
- Capacitance Y Value: 0.0022 μ F, 0.0033 μ F, and 0.0044 μ F
- Lead Spacing: 20 mm
- Capacitance Tolerance: \pm 20%



Customer Part Number System

PZB300	M	C	11	R30
Series	Rated Voltage (VAC)	Lead Spacing (mm)	Capacitance Code (pF)	Packaging
Delta EMI, X2 + 2xY2, Metallized Paper	M = 275	C = 20.0	The first digit indicates the value of the X capacitor: 1 = 0.10 μ F 2 = 0.15 μ F The second digit indicates the value of the Y capacitor: 1 = 0.0022 μ F 2 = 0.0033 μ F 3 = 0.0047 μ F	See Ordering Options Table

KEMET Internal Part Number System

P	300	P	L	104	M	275	A	C222
Capacitor Class	Series	Lead Spacing (mm)	Size Code	X Capacitance Code (pF)	Capacitance Tolerance	Rated Voltage (VAC)	Packaging	Y Capacitance Code
P = Paper	Delta EMI, X2 + 2x Y2, Metallized Paper	P = 20	See Dimension Table	The first two digits indicate the two most significant digits of the capacitance value in picofarads. The third digit is the number of following zeros.	M = \pm 20%	275 = 275	See Ordering Options Table	C plus the first two digits represent significant figures. The third digit specifies number of zeros.

Benefits cont.

- Climatic Category: 40/100/56/B, IEC 60068-1
- Tape & Reel packaging in accordance with IEC 60286-2
- RoHS compliance and lead-free terminations
- Operating temperature range of -40°C to +100°C
- 100% screening factory test at 2,150 VDC/1,500 VAC
- Excellent self-healing properties ensure long life, even when subjected to frequent overvoltages
- Good resistance to ionization due to impregnated paper dielectric
- High dv/dt capability
- Impregnated paper that ensures excellent stability and reliability properties, particularly in applications with continuous operation

Ordering Options Table

Lead Spacing Nominal (mm)	Type of Leads and Packaging	Lead Length (mm)	KEMET Lead and Packaging Code	Legacy Lead and Packaging Code
20	Standard Lead and Packaging Options			
	Bulk (Bag) – Short Leads	6 +0/-1	C	R06
	Bulk (Bag)– Maximum Length Leads	30 +5/-0	A	R30

Dimensions – Millimeters

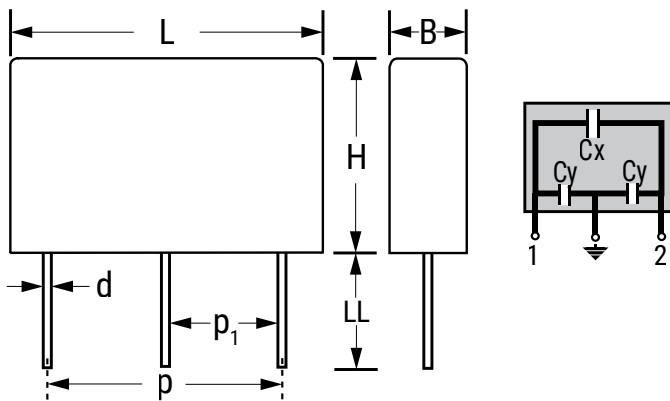

p		p ₁		B		H		L		d	
Nominal	Tolerance	Nominal	Tolerance	Nominal	Tolerance	Nominal	Tolerance	Nominal	Tolerance	Nominal	Tolerance
20.0	±0.5	10.0	Nominal	12.5	Maximum	16.0	Maximum	24.0	Maximum	0.8	±0.05

Note: See the Ordering Options Table for lead length (LL) options.



Performance Characteristics

Rated Voltage	275 VAC 50/60 Hz	
Capacitance Range	0.1 μ F – 0.15 μ F	
Capacitance Tolerance	\pm 20%	
Temperature Range	-40°C to +100°C	
Climatic Category	40/100/56/B	
Approvals	ENEC, UL, CSA	
Dissipation Factor	Maximum Values at +23°C	
	1 kHz	1.3%
Test Voltage Between Terminals	The 100% screening factory test is carried out at 2,150 VDC for X2 capacitors and 3,000 VDC for Y2 capacitors. The voltage level is selected to meet the requirements in applicable equipment standards. All electrical characteristics are checked after the test. This test may not be repeated due to potential capacitor damage. KEMET is not liable for any failures that result from repeating the test.	
Insulation Resistance	Between Terminals	
	\geq 12,000 M Ω	

Environmental Test Data

Test	IEC Publication	Procedure
Vibration	IEC 60068-2-6 Test Fc	3 directions at 2 hours each, 10 – 500 Hz at 0.75 mm or 98 m/s ² (PZB300 MCx mounted on PC board)
Bump	IEC 60068-2-29 Test Eb	4,000 bumps at 390 m/s ²
Solderability	IEC 60068-2-20 Test Ta	Solder globule method Wetting time < 1 second
Active Flammability	IEC 60384-14	V _R + 20 surge pulses at 2.5 kV (pulse every 5 seconds)
Passive Flammability	IEC 60384-14	IEC 60384-1, IEC 60695-11-5 Needle-flame test
Humidity	IEC 60068-2-3 Test Ca	+40°C and 90 – 95% R.H., 56 days

Approvals

Certification Body	Mark	Specification	File Number
Intertek Semko AB		EN/IEC 60384-14	SE/0140-24E
UL		UL 60384-14 CAN/CSA-E60384-14-09	E73869

Environmental Compliance

All KEMET EMI capacitors are RoHS compliant.



Table 1 – Ratings & Part Number Reference

Cx (μ F)	Cy (μ F)	Maximum Dimensions in mm			Lead Spacing (p)	Package Quantity				New KEMET Part Number	Legacy Part Number
		B	H	L		A (R30)	C (R06)	dV/dt Cx	dV/dt Cy		
0.10	0.0022	12.5	16.0	24.0	20.0	150	1,000	600	1,000	P300PL104M275(1)C222	PZB300MC11(1)
0.10	0.0033	12.5	16.0	24.0	20.0	150	1,000	600	1,000	P300PL104M275(1)C332	PZB300MC12(1)
0.10	0.0047	12.5	16.0	24.0	20.0	150	1,000	600	1,000	P300PL104M275(1)C472	PZB300MC13(1)
0.15	0.0022	12.5	16.0	24.0	20.0	150	1,000	600	1,000	P300PL154M275(1)C222	PZB300MC21(1)
0.15	0.0033	12.5	16.0	24.0	20.0	150	1,000	600	1,000	P300PL154M275(1)C332	PZB300MC22(1)
0.15	0.0047	12.5	16.0	24.0	20.0	150	1,000	600	1,000	P300PL154M275(1)C472	PZB300MC23(1)
Cx (μ F)	Cy (μ F)	B (mm)	H (mm)	L (mm)	Lead Spacing (p)	A (R30)	C (R06)	dV/dt Cx	dV/dt Cy	New KEMET Part Number	Legacy Part Number

(1) Insert lead and packaging code. See Ordering Options Table for available options.

Soldering Process

The implementation of the RoHS directive has resulted in the selection of SnAuCu (SAC) alloys or SnCu alloys as primary solder. This has increased the liquidus temperature from 183°C for SnPb eutectic alloys to 217 – 221°C for the new alloys. As a result the heat stress to the components, even in wave soldering, has increased considerably due to higher pre-heat and wave temperatures. Polypropylene capacitors are especially sensitive to heat (the melting point of polypropylene is 160 – 170°C). Wave soldering can be destructive, especially for mechanically small polypropylene capacitors (with lead spacing of 5 – 15 mm), and great care must be taken during soldering. The recommended solder profiles from KEMET should be used. Consult KEMET with any questions. In general, the wave soldering curve from IEC Publication 61760-1 Edition 2 serves as a solid guideline for successful soldering. See Figure 1.

Reflow soldering is not recommended for through-hole film capacitors. Exposing capacitors to a soldering profile in excess of the recommended limits may result in degradation of or permanent damage to the capacitors.

Do not place the polypropylene capacitor through an adhesive curing oven to cure resin for surface mount components. Insert through-hole parts after curing the surface mount parts. Consult KEMET to discuss the actual temperature profile in the oven, if through-hole components must pass through the adhesive curing process. A maximum of two soldering cycles is recommended. Allow time for the capacitor surface temperature to return to a normal temperature before the second soldering cycle.

Manual Soldering Recommendations

Following is the recommendation for manual soldering with a soldering iron.

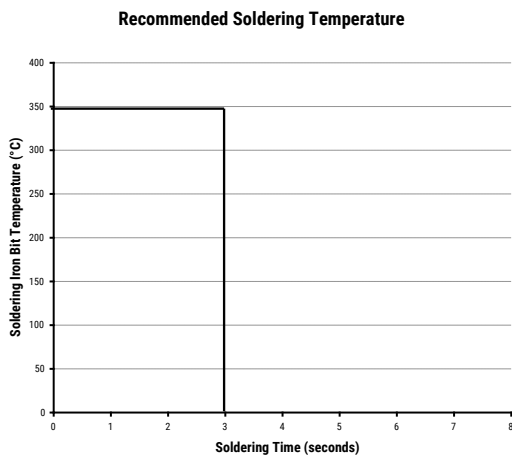

The soldering iron tip temperature should be set at 350°C (+10°C maximum) with the soldering duration not to exceed more than 3 seconds.

Wave Soldering Recommendations

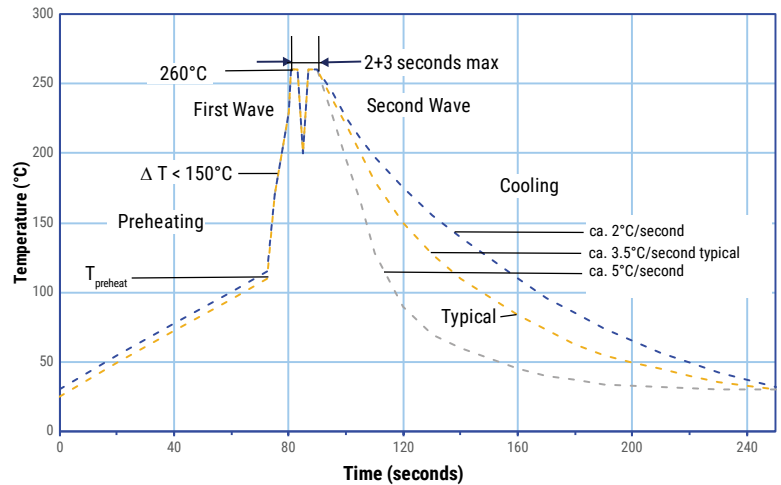

Soldering Process cont.

Wave Soldering Recommendations cont.

1. The table indicates the maximum setup temperature of the soldering process.
Figure 1

Dielectric Film Material	Maximum Preheat Temperature			Maximum Peak Soldering Temperature	
	Capacitor Pitch ≤ 10 mm	Capacitor Pitch = 15 mm	Capacitor Pitch > 15 mm	Capacitor Pitch ≤ 15 mm	Capacitor Pitch > 15 mm
Polyester	130°C	130°C	130°C	270°C	270°C
Polypropylene	100°C	110°C	130°C	260°C	270°C
Paper	130°C	130°C	140°C	270°C	270°C
Polyphenylene Sulphide	150°C	150°C	160°C	270°C	270°C

2. The maximum temperature measured inside the capacitor: set the temperature so that the maximum temperature is below the limit inside the element.

Dielectric Film Material	Maximum Temperature Measured Inside the Element
Polyester	160°C
Polypropylene	110°C
Paper	160°C
Polyphenylene Sulphide	160°C

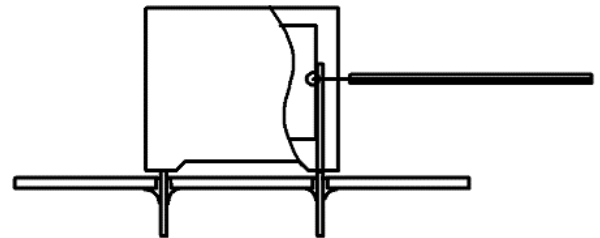

The temperature is monitored inside the capacitor.

Selective Soldering Recommendations

Selective dip soldering is a variation of reflow soldering. In this method the printed circuit board with through-hole components to be soldered is preheated and transported over the solder bath, as in normal flow soldering, without touching the solder. When the board is over the bath, it is stopped. Pre-designed solder pots are lifted from the bath with molten solder only at the places of the selected components, and then pressed against the lower surface of the board to solder the components.

The temperature profile for selective soldering is similar to the profile for double wave flow soldering outlined in this document. **However, instead of two baths, there is only one with a time from 3 to 10 seconds.** In selective soldering, the risk of overheating is greater than in double wave flow soldering, and great care must be taken so that the parts do not overheat.

Marking

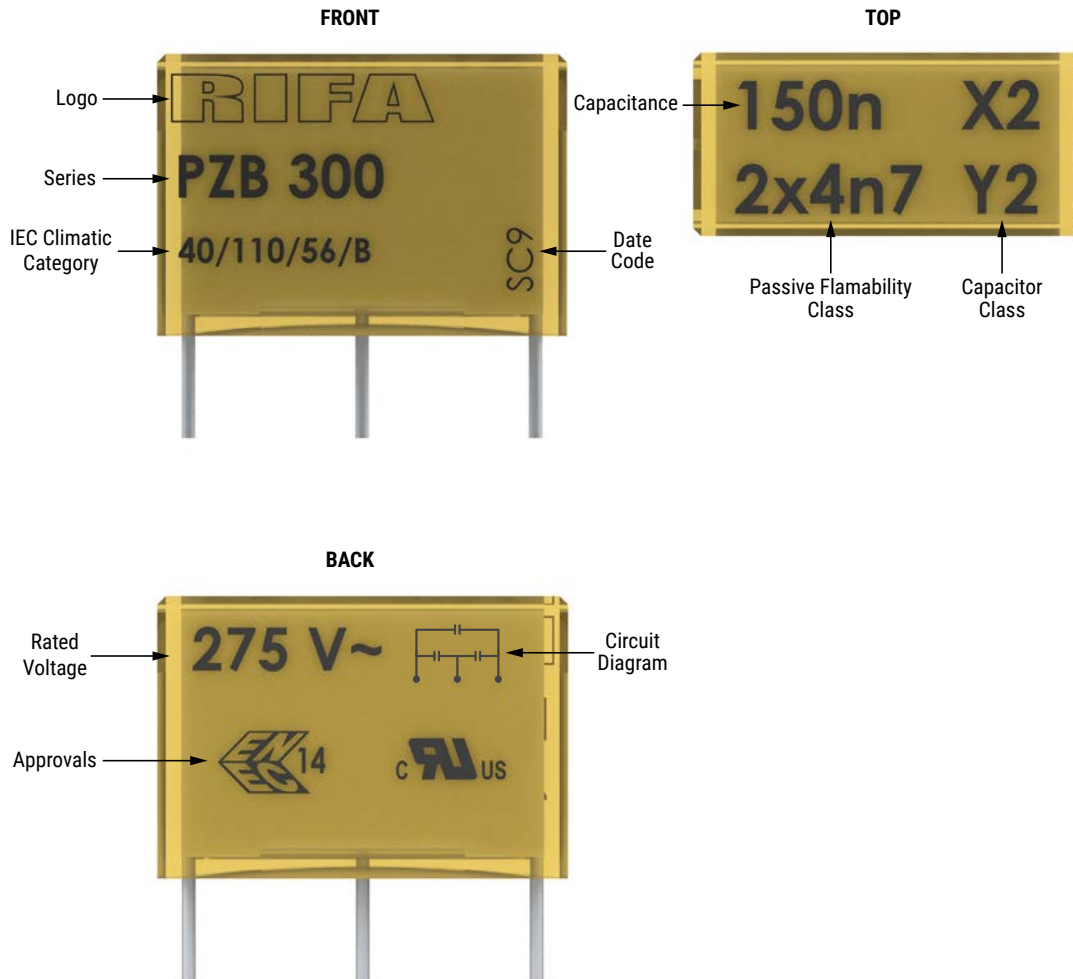

Manufacturing Date Code (IEC-60062)

Y = Year, Z = Month					
Year	Code	Year	Code	Month	Code
2010	A	2022	P	January	1
2011	B	2023	R	February	2
2012	C	2024	S	March	3
2013	D	2025	T	April	4
2014	E	2026	U	May	5
2015	F	2027	V	June	6
2016	H	2028	W	July	7
2017	J	2029	X	August	8
2018	K	2030	A	September	9
2019	L			October	0
2020	M			November	N
2021	N			December	D

KEMET Electronics Corporation Sales Offices

For a complete list of our global sales offices, please visit www.kemet.com/sales.

Disclaimer

YAGEO Corporation and its affiliates do not recommend the use of commercial or automotive grade products for high reliability applications or manned space flight.

All product specifications, statements, information and data (collectively, the "Information") in this datasheet are subject to change. The customer is responsible for checking and verifying the extent to which the Information contained in this publication is applicable to an order at the time the order is placed. All Information given herein is believed to be accurate and reliable, but it is presented without guarantee, warranty, or responsibility of any kind, expressed or implied.

Statements of suitability for certain applications are based on KEMET Electronics Corporation's ("KEMET") knowledge of typical operating conditions for such applications, but are not intended to constitute – and KEMET specifically disclaims – any warranty concerning suitability for a specific customer application or use. The Information is intended for use only by customers who have the requisite experience and capability to determine the correct products for their application. Any technical advice inferred from this Information or otherwise provided by KEMET with reference to the use of KEMET's products is given gratis, and KEMET assumes no obligation or liability for the advice given or results obtained.

Although KEMET designs and manufactures its products to the most stringent quality and safety standards, given the current state of the art, isolated component failures may still occur. Accordingly, customer applications which require a high degree of reliability or safety should employ suitable designs or other safeguards (such as installation of protective circuitry or redundancies) in order to ensure that the failure of an electrical component does not result in a risk of personal injury or property damage.

Although all product-related warnings, cautions and notes must be observed, the customer should not assume that all safety measures are indicated or that other measures may not be required.

Additional information about production site flexibility can be found [here](#)

KEMET is a registered trademark of KEMET Electronics Corporation.

Mouser Electronics

Authorized Distributor

Click to View Pricing, Inventory, Delivery & Lifecycle Information:

KEMET:

[PZB300MC11R30](#) [PZB300MC12R30](#) [PZB300MC13R30](#) [PZB300MC21R30](#) [PZB300MC22R30](#) [PZB300MC23R30](#)
[PZB300MC13R03](#) [PZB300MC13R05](#)