

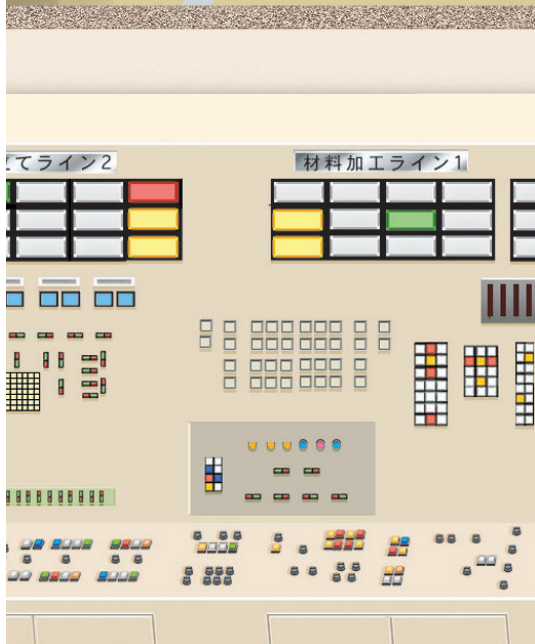

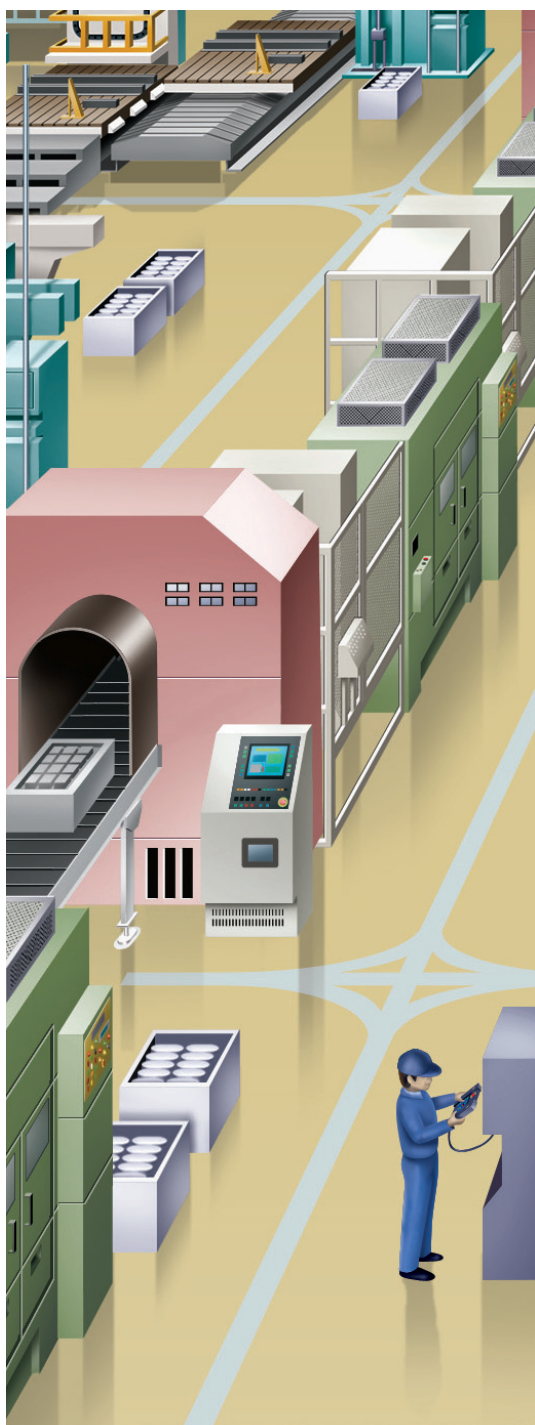









































∅25mm TWS Series



















Control Units





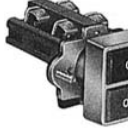

















ø25 TWS Series Control Units (Selection Guide)











Function	Pushbutton				
Category	Flush	Extended	Extended with Half Shroud	Extended with Full Shroud	Mushroom
	Momentary/Maintained				
Shape	    	    	    	    	    
Type	ABS1 AOS1	ABS2 AOS2	ABGS2 AOGS2	ABFS2 AOFSS2	ABS3 AOS3
Page	9	9	9	9	10











Function	Pushbutton			
Category	Mushroom with Full Shroud	Mushroom Pushlock Turn Reset	Mushroom Push Turn Lock	Mushroom Push-Pull
	Momentary/Maintained			
Shape	    	   	    	   
Type	ABGS3 AOGS3	AVS3	AJS3	AYS3
Page	10	10	10	11

Function	Pushbutton			
Category	Square Flush	Square Extended	Square Twin Momentary	Square Twin Maintained
	Momentary/Maintained			
Shape	    	    	   	   
Type	UBQS1 UOQS1	UBQS2	UWQN1	UWQN2
Page	11	11	12	12

Function	Pilot Light (LED/Incandescent)				
Category	Dome	Square (Marking) (Plastic Bezel)	Square (Marking) (Metal Bezel)	Rectangular (Marking) (Plastic Bezel)	Dome Push-to-Check
	Shape	    	    	    	    
Type	APS1	UPQS1B	UPQMS1B	UPQS4B	APS1*PN
Page	13	13	13	13	13

TWS Series Control Units (Selection Guide) ø25

Function	Illuminated Pushbutton (LED/Incandescent)				
Category	Extended (Non-marking)	Extended with Half Shroud (Non-marking)	Extended with Full Shroud (Non-marking)	ø35mm Mushroom (Non-marking)	Mushroom Pushlock Turn Reset
Shape	 	 	 	 	 
Type	ALS2 AOLS2	ALGS2 AOLGS2	ALFS2 AOLFS2	ALS3 AOLS3	AVLS3
Page	15	16	17	18	18



Function	Illuminated Pushbutton (LED/Incandescent)	Selector Switch			Illuminated Selector Switch (LED/Incandescent)
Category	Square Flush (Marking)	Knob	Lever	Key	Knob
Shape	 	 	 	 	 
Type	ULQS1B UOLQS1B	ASS	ASS*L	ASS*K	ASLS
Page	19	21	22	23	24

ø25 TWS series Control Units

Highly reliable heavy-duty type control units Suitable for industrial use

- HW-C contact blocks are used.
- Degree of protection: IP65 (IEC 60529)
- UL and CSA approved, EN compliant



Safety Standards	File No. or Organization
UL 	UL Listing File No. E68961
CSA 	File No. LR21451
EN EN60947-1 EN60947-5-1	 TÜV Rheinland



Specifications and Ratings

Contact Ratings

Contact Block	Rated Insulation Voltage	600V
	Rated Continuous Current	10A
	Contact Ratings by Utilization Category IEC 60947-5-1	AC-15 (A600) DC-13 (P600)

Characteristics

• Contact Ratings by Utilization Category

Operational Voltage		24V	48V	50V	110V	220V	440V	
Operational Current	AC 50/60 Hz	AC-12 Control of resistive loads and solid state loads	10A	—	10A	10A	6A	2A
		AC-15 Control of electromagnetic loads (> 72 VA)	10A	—	7A	5A	3A	1A
	DC	DC-12 Control of resistive loads and solid state loads	8A	4A	—	2.2A	1.1A	—
		DC-13 Control of electromagnets	4A	2A	—	1.1A	0.6A	—

Minimum applicable load: 3V AC/DC, 5 mA (applicable range may vary with operating conditions and load types)

For the control units listed below, the rated current (load switching current) is reduced to a half of the rated operational current of the contact block. The rated insulation voltage (600V) and the rated thermal current (10A) remain unchanged.

- Selector switches and illuminated selector switches with contact code 2R, 3S, 4S, or 4R.

HW-C (Contact Block)

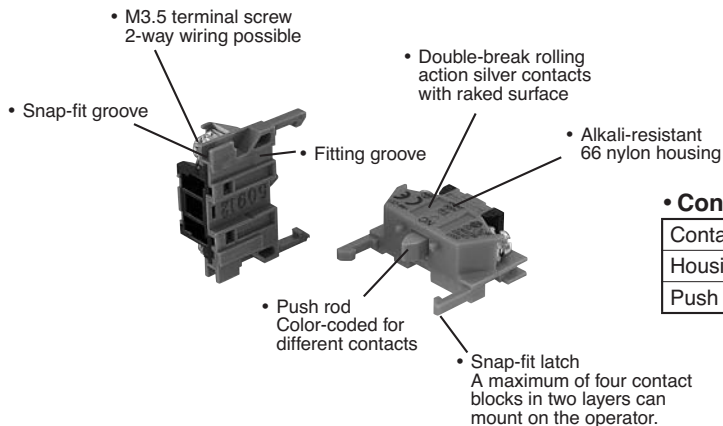

• Contact Block Types

Contact	NO	NC	NO (early make)	NC (late break)
Housing	Blue	Purple red	Blue	Purple red
Push Rod	Green	Red	Black	White

Note: BS type contact block is used for square twin pushbuttons UWQN1 and UWQN2.

Specifications

Operating Temperature	-25 to +50°C (no freezing)
Operating Humidity	45 to 85% RH (no condensation)
Contact Resistance	50 mΩ maximum (initial value)
Insulation Resistance	100 MΩ minimum (500V DC megger)
Dielectric Strength	Between live and dead metal parts: 2,500V AC, 1 minute (Full voltage type illuminated units: 2,000V AC, 1 minute)
Vibration Resistance	Operating extremes: 5 to 55 Hz, amplitude 0.5 mm
Shock Resistance	Damage limits: 1,000 m/s ² Operating extremes: 100 m/s ²
Mechanical Life (minimum operations)	Pushbuttons, Illuminated pushbuttons Momentary: 5,000,000 Others: 500,000 Pushlock turn reset: 250,000 Selector switches: 500,000 Key selector switches: 500,000 Illuminated selector switches: 500,000
Electrical Life (minimum operations)	Pushbuttons: 500,000 *1 Illuminated pushbuttons: 500,000 *1 Pushlock turn reset: 250,000 *1 Square twin maintained: 500,000 *2 Selector switches: 500,000 *3 Key selector switches: 500,000 *3 Illuminated selector switches: 250,000 *3 Others: 500,000 *1 *1 Switching frequency 1,800 operations/h, duty ratio 40% *2 Switching frequency 900 operations/h, duty ratio 40% *3 Switching frequency 1,200 operations/h, duty ratio 40%

LED Illuminated Unit Specifications

Unit	Color Code ②	Input Type	Operating Voltage	LED Lamp		
				Lamp Base	Type No.	Voltage
Pilot Light Illuminated Pushbutton Illuminated Selector Switch	A: amber G: green PW: pure white R: red S: blue W: white Y: yellow	Full Voltage	6V AC/DC	BA9S/13	LSTD-6②	6V AC/DC ±10%
			12V AC/DC		LSTD-1②	12V AC/DC ±10%
			24V AC/DC		LSTD-2②	24V AC/DC ±10%
		Transformer	100/110V AC/DC 115V AC/DC 120V AC/DC 200/220V AC/DC 230V AC/DC 240V AC/DC 380V AC/DC 400/440V AC/DC (50/60 Hz)	LSTD-6②	6V AC/DC ±10%	
			DC-DC Converter	110V DC	LSTD-6②	6V AC/DC ±10%

Incandescent Illuminated Unit Specifications

Unit	Color Code ②	Input Type	Operating Voltage	Incandescent Lamp		
				Lamp Base	Type No.	Rating
Pilot Light Illuminated Pushbutton Illuminated Selector Switch	A: amber C: clear G: green R: red S: blue W: white	Full Voltage	6V AC/DC	BA9S/13	LS-6	1W (6.3V)
			12V AC/DC		LS-8	1W (18V)
			24V AC/DC		LS-3	1W (30V)
		Transformer	100/110V AC/DC 115V AC/DC 120V AC/DC 200/220V AC/DC 230V AC/DC 240V AC/DC 380V AC/DC 400/440V AC/DC 480V AC/DC (50/60 Hz)	BA9S/13	LS-6	1W (6.3V)

ø25 TWS Series Control Units

LED Lamp Ratings (LSTD Type)

Type No.	LSTD-6②		LSTD-1②	LSTD-2②
Lamp Base	BA9S/13			
Rated Voltage	6V AC/DC		12V AC/DC	24V AC/DC
Voltage Range	6V AC/DC ±10%		12V AC/DC ±10%	24V AC/DC ±10%
Current Draw	AC	A, R, W, Y: 17 mA, G, PW, S: 8 mA	11 mA	11 mA
	DC	A, R, W, Y: 14 mA, G, PW, S: 5.5 mA	10 mA	10 mA
Color Code ②	A (amber), G (green), PW (pure white), R (red), S (blue), W (white), Y (yellow)			
Lamp Base Color	Same as illumination color			
Voltage Marking	Die stamped on the base			
Life (reference value)	Approx. 50,000 hours (The luminance is reduced to 50% the initial intensity when used on complete DC.)			
Internal Circuit	A, R, W, Y			
	G, PW, S			
			LED Chip Protection Diode Zener Diode	

Incandescent Lamp Ratings (LS Type)

Type No.	LS-6	LS-8	LS-2	LS-3
Lamp Base	BA9S/13			
Rated Voltage	6V AC/DC	12V AC/DC	18V AC/DC	24V AC/DC
Wattage	1W (6.3V)	1W (18V)	1W (24V)	1W (30V)
Voltage Marking	Die stamped on the base			
Life (reference value)	Approx. 1,000 hours minimum (mean value when used on the rated voltage)			

Mounting Hole Layout

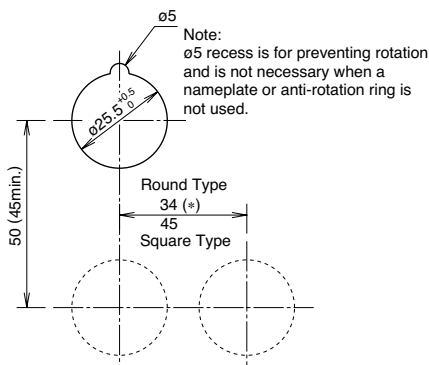

Note: The minimum mounting centers are applicable to switches with one layer of contact blocks (two contact blocks). When two layers of contact blocks are mounted, determine the minimum mounting centers in consideration of convenience for wiring.

- ø35mm mushroom: 35 mm minimum
- Mushroom with shroud: 42 mm minimum
- 2-position, 3-position lever type selector switch: 42 mm minimum
- 4-position, 5-position lever type selector switch: 50 mm minimum

Degree of Protection

Type No.	Unit	NEMA ICS 6-110	IEC 60529
A****	Pushbuttons, pilot lights, illuminated pushbuttons, and selector switches	Type 1, 2, 3, 3R, 4, 5, 12, 13	IP65
	Illuminated selector switches and key selector switches	Type 1, 2, 3R, 5, 12, 13	IP54
U****	Square pushbuttons, square pilot lights, and square illuminated pushbuttons	Type 1, 2	IP40

Ordering Information

Standard Units

- Specify an operator or lens color code in the Type No.
- Full voltage type illuminated units are not supplied with a lamp. Order LED or incandescent lamps separately. Transformer and DC-DC converter type illuminated units contain an LED or incandescent lamp.
- All standard units are UL, CSA, EN, and TÜV approved (except DC-DC converter type).
- Terminal covers, nameplates, and accessories are ordered separately.

Terminal Cover

- When a terminal cover is required, order an applicable terminal cover referring to page 29.

The Type No. development charts shown below can be used to specify control units other than those listed on the following pages.

Pushbuttons

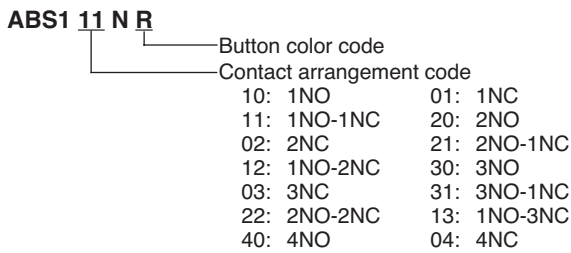

Note:

- Push-pull type AYS3 can have a maximum of two contact blocks.

Pilot Lights

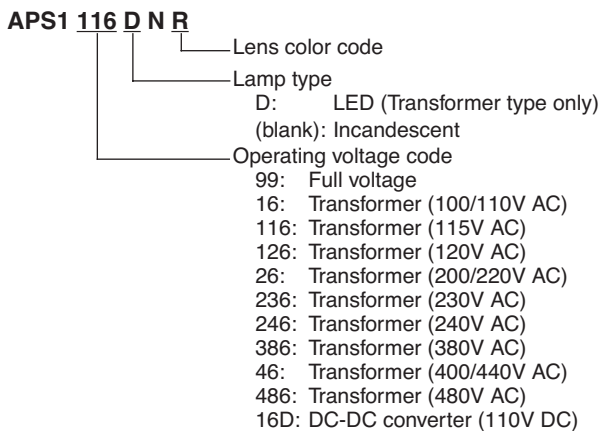

Note:

- Full voltage type is not supplied with a lamp.
- Transformer and DC-DC converter types contain an LED lamp (LSTD-6②) or incandescent lamp (LS-6).

Illuminated Pushbuttons

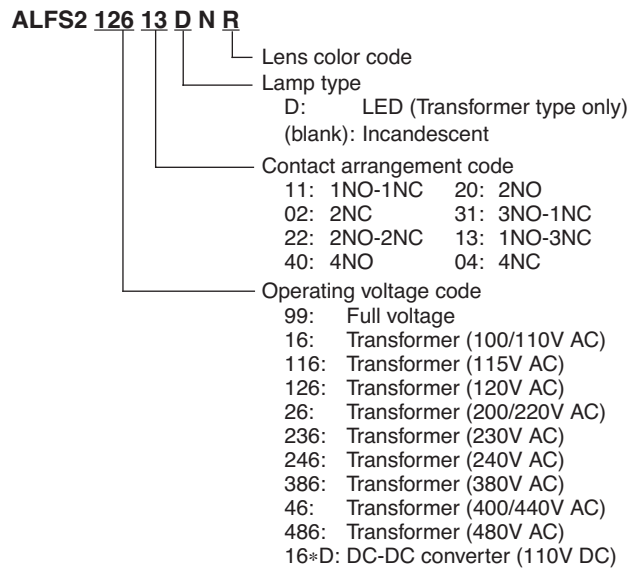

Note:

- Full voltage type is not supplied with a lamp.
- Transformer and DC-DC converter types contain an LED lamp (LSTD-6②) or incandescent lamp (LS-6).

ø25 TWS Series Control Units (Ordering Information)

Selector Switch

ASS 2 L 11 N

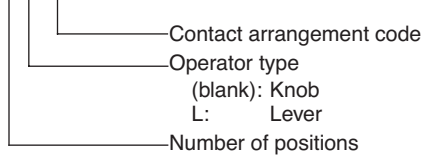

Note:

- See pages 26 to 28 for contact arrangement codes.

Key Selector Switch

ASS 2 K 20 N B

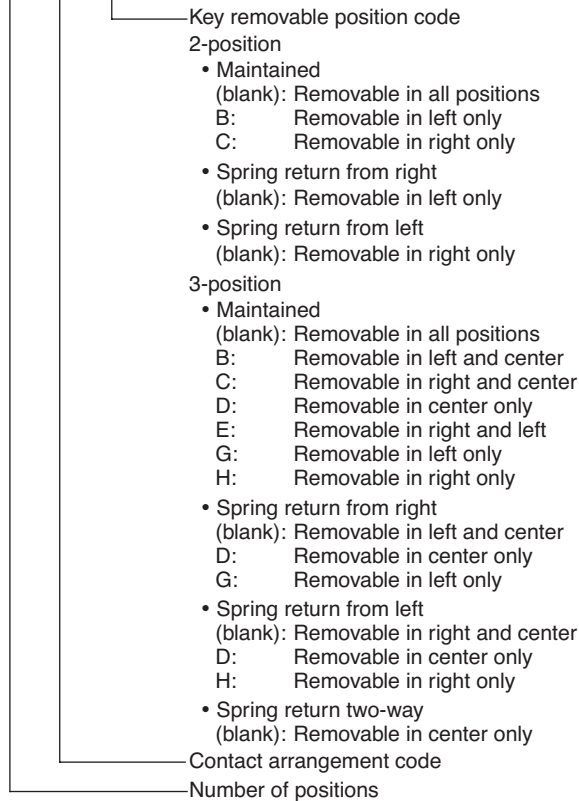

Note:

- See page 26 to 28 for contact arrangement codes.
- The key cannot be removed in the return position.

Illuminated Selector Switch



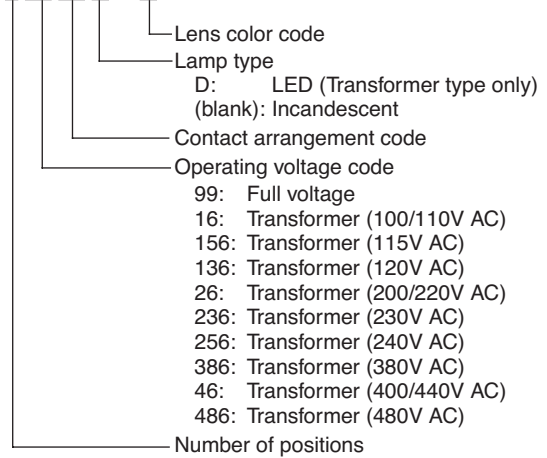





ASLS 2 16 22 D N R

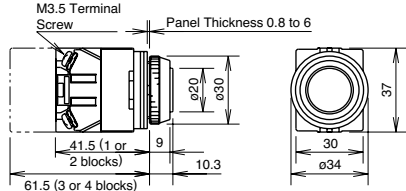

Note:

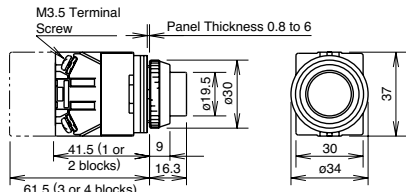
- Full voltage type is not supplied with a lamp.
- Transformer type contains an LED lamp (LSTD-6②) or incandescent lamp (LS-6).
- See pages 26 to 28 for contact arrangement codes.

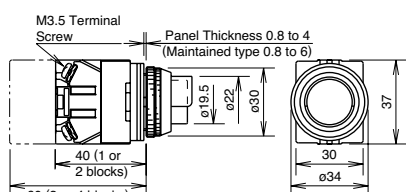

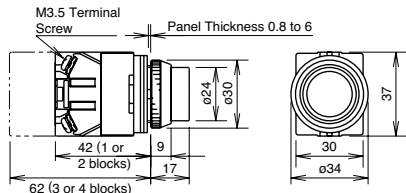





Flush / Extended Types

Shape	Operation Type	Contact	Type No.	① Button Color Code	Dimensions (mm)
Flush ABS1 AOS1  	Momentary	1NO	ABS110N①	Black (B), green (G), and red (R) buttons are supplied with each unit as standard. Specify S, W, or Y when a blue, white, or yellow button is required.	 <p>Note: The depth behind the panel of the maintained type is 1.5mm longer than the momentary type.</p>
		1NC	ABS101N①		
		1NO-1NC	ABS111N①		
		2NO	ABS120N①		
		2NC	ABS102N①		
	Maintained	2NO-2NC	ABS122N①		
		1NO	AOS110N①		
		1NC	AOS101N①		
		1NO-1NC	AOS111N①		
		2NO	AOS120N①		
2NC	AOS102N①				
2NO-2NC	AOS122N①				
Extended ABS2 AOS2  	Momentary	1NO	ABS210N①	Specify a button color code in place of ① in the Type No. B: black G: green R: red S: blue W: white Y: yellow	 <p>Note: The depth behind the panel of the maintained type is 1.5mm longer than the momentary type.</p>
		1NC	ABS201N①		
		1NO-1NC	ABS211N①		
		2NO	ABS220N①		
		2NC	ABS202N①		
	Maintained	2NO-2NC	ABS222N①		
		1NO	AOS210N①		
		1NC	AOS201N①		
		1NO-1NC	AOS211N①		
		2NO	AOS220N①		
2NC	AOS202N①				
2NO-2NC	AOS222N①				
Extended with Half Shroud ABGS2 AOGS2  	Momentary	1NO	ABGS210N①	Specify a button color code in place of ① in the Type No. B: black G: green R: red S: blue W: white Y: yellow	 <p>Note: The depth behind the panel of the maintained type is 1.5mm longer than the momentary type.</p>
		1NC	ABGS201N①		
		1NO-1NC	ABGS211N①		
		2NO	ABGS220N①		
		2NC	ABGS202N①		
	Maintained	2NO-2NC	ABGS222N①		
		1NO	AOGS210N①		
		1NC	AOGS201N①		
		1NO-1NC	AOGS211N①		
		2NO	AOGS220N①		
2NC	AOGS202N①				
2NO-2NC	AOGS222N①				
Extended with Full Shroud ABFS2 AOFS2  	Momentary	1NO	ABFS210N①	Specify a button color code in place of ① in the Type No. B: black G: green R: red S: blue W: white Y: yellow	 <p>Note: The depth behind the panel of the maintained type is 1.5mm longer than the momentary type.</p>
		1NC	ABFS201N①		
		1NO-1NC	ABFS211N①		
		2NO	ABFS220N①		
		2NC	ABFS202N①		
	Maintained	2NO-2NC	ABFS222N①		
		1NO	AOFS210N①		
		1NC	AOFS201N①		
		1NO-1NC	AOFS211N①		
		2NO	AOFS220N①		
2NC	AOFS202N①				
2NO-2NC	AOFS222N①				

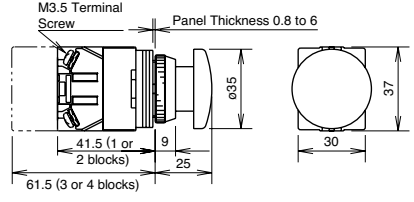
- Specify a button color code in place of ① in the Type No.
- Round bezel and shroud (metal): Chrome-plated
- Pushbuttons with one or three contact blocks contain a dummy block.
- Other contact arrangements are also available. See page 7.

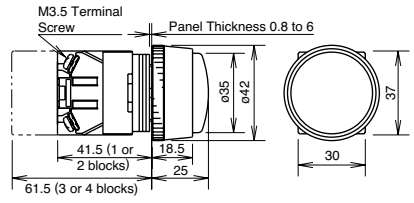
ø25 TWS Series Pushbuttons

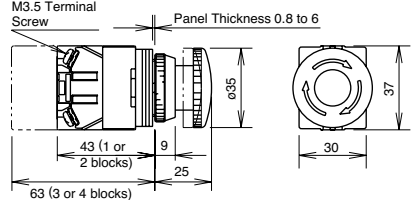
Mushroom / Pushlock Turn Reset / Push Turn Lock Types

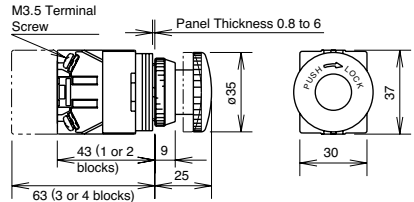
Shape	Operation Type	Contact	Type No.	① Button Color Code	Dimensions (mm)
Mushroom ABS3 AOS3  	Momentary	1NO	ABS310N①	Specify a button color code in place of ① in the Type No. B: black G: green R: red S: blue W: white Y: yellow	 <p>Note: The depth behind the panel of the maintained type is 1.5mm longer than the momentary type.</p>
		1NC	ABS301N①		
		1NO-1NC	ABS311N①		
		2NO	ABS320N①		
		2NC	ABS302N①		
	Maintained	2NO-2NC	ABS322N①		
		1NO	AOS310N①		
		1NC	AOS301N①		
		1NO-1NC	AOS311N①		
		2NO	AOS320N①		
Mushroom with Full Shroud ABGS3 AOGS3  	Momentary	1NO	ABGS310N①	B: black G: green R: red S: blue W: white Y: yellow	 <p>Note: The depth behind the panel of the maintained type is 1.5mm longer than the momentary type.</p>
		1NC	ABGS301N①		
		1NO-1NC	ABGS311N①		
		2NO	ABGS320N①		
		2NC	ABGS302N①		
	Maintained	2NO-2NC	ABGS322N①		
		1NO	AOGS310N①		
		1NC	AOGS301N①		
		1NO-1NC	AOGS311N①		
		2NO	AOGS320N①		
Pushlock Turn Reset AVS3  		1NO	AVS310N①	R: red Y: yellow	
		1NC	AVS301N①		
		1NO-1NC	AVS311N①		
		2NO	AVS320N①		
		2NC	AVS302N①		
		2NO-2NC	AVS322N①		
Push Turn Lock AJS3  		1NO	AJS310N①	B: black G: green R: red Y: yellow	
		1NC	AJS301N①		
		1NO-1NC	AJS311N①		
		2NO	AJS320N①		
		2NC	AJS302N①		
		2NO-2NC	AJS322N①		







- Specify a button color code in place of ① in the Type No.
- Round bezel (metal): Chrome-plated
- Pushbuttons with one or three contact blocks contain a dummy block.
- Other contact arrangements are also available. See page 7.

• **Pushlock Turn Reset:** Button is maintained when pressed and is reset when turned clockwise.

Note: AVS3 cannot be used as emergency stop switches. When emergency stop switches are required, use XW or HW series emergency stop switches (ISO 13850 and IEC 60947-5-5 compliant).

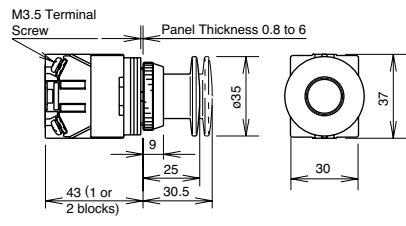

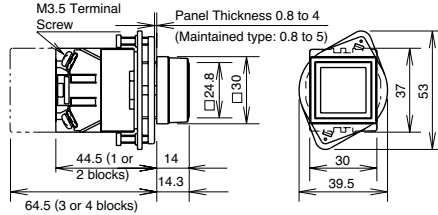

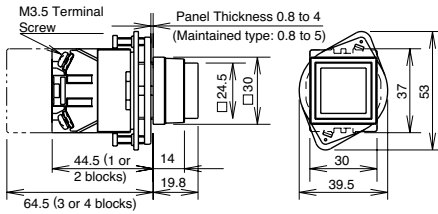











• **Push Turn Lock:** Button is locked when turned clockwise in the depressed position and is reset when turned counterclockwise.

Push-Pull / Square Flush / Square Extended Types

Shape	Operation Type	Contact	Type No.	① Button Color Code	Dimensions (mm)	
Mushroom Push-Pull AYS31  	Maintained	1NO	AYS3110N①	B: black G: green R: red Y: yellow		
		1NC	AYS3101N①			
		1NO-1NC	AYS3111N①			
		2NO	AYS3120N①			
		2NC	AYS3102N①			
Square Flush UBQS1 UOQS1  	Momentary	1NO	UBQS110N①	B: black G: green R: red S: blue Y: yellow		
		1NC	UBQS101N①			
		1NO-1NC	UBQS111N①			
		2NO	UBQS120N①			
		2NC	UBQS102N①			
	Maintained	2NO-2NC	UBQS122N①			Note: The depth behind the panel of the maintained type is 1.5mm longer than the momentary type.
		1NO	UOQS110N①			
		1NC	UOQS101N①			
		1NO-1NC	UOQS111N①			
		2NO	UOQS120N①			
Square Extended UBQS2  	Momentary	1NO	UBQS210N①			
		1NC	UBQS201N①			
		1NO-1NC	UBQS211N①			
		2NO	UBQS220N①			
		2NC	UBQS202N①			
		2NO-2NC	UBQS222N①			

- Specify a button color code in place of ① in the Type No.
- Round bezel (metal): Chrome-plated
- Square bezel (plastic): Black
- Pushbuttons with one or three contact blocks contain a dummy block.
- Other contact arrangements are also available. See page 7.
- **Push-Pull:** Button is maintained in both depressed and reset positions. Up to 2 contact blocks (1 layer) can be mounted on AYS31 push-pull switches.

• Contact Statuses of Push-Pull Switch

Contact	AYS31	
	Push	Pull
1NO		
1NC		
1NO-1NC	 	 
2NO	 	 
2NC	 	 

- Note: Push-pull switch can have a maximum of two contact blocks.

• Panel Mounting of Square Types

1. Tighten the square bezel to the operator and position the ring correctly.
2. Lightly tighten the screw to secure the pushbutton onto the panel.

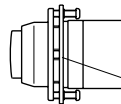





Tighten the screw lightly so that this plate does not bend.

Recommended tightening torque:
0.15 N·m



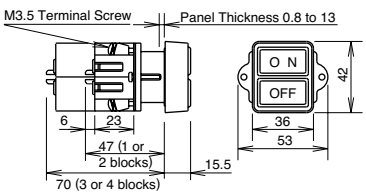
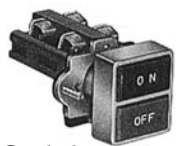

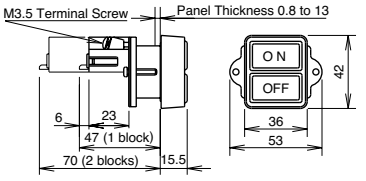





ø25 TWS Series Pushbuttons

Square Twin Types

Shape	Contact		Type No.	Button Color	Dimensions (mm)
Square Twin (Momentary) UWQN1  	ON	OFF		ON: Black OFF: Red	
	1NO	1NO	UWQN11010		
	1NO	1NC	UWQN11001		
	2NO	2NC	UWQN12002		
Square Twin (Maintained) UWQN2  	1NO		UWQN21000	ON: Black OFF: Red	
	1NC		UWQN20100		
	1NO-1NC		UWQN21100		
	2NO		UWQN22000		
	2NC		UWQN20200		

- **Square Twin (Momentary):** Two independent momentary switches are contained in one unit, each operated by ON or OFF button. With the ø30 adapter removed from the sleeve, the unit can mount in a ø25.5mm mounting hole for the ø25 series.
- **Square Twin (Maintained):** The contact operates when ON button is pressed and is maintained in the depressed position. The button is reset by pressing the OFF button. With the ø30 adapter removed from the sleeve, the unit can mount in a ø25.5mm mounting hole for the ø25 series.

Dome / Square / Rectangular (Marking) Types

Shape	Lamp	Input Type	Type No.	② Lens/LED Color Code	③ Operating Voltage Code
Dome APS1  	Without Lamp	Full Voltage	APS199N②	A, C, G, R, S, W, Y	Specify an operating voltage code in place of ③ in the Type No. 16: 100/110V AC 116: 115 AC 126: 120V AC 26: 200/220V AC 236: 230V AC 246: 240V AC 386: 380V AC 46: 400/440V AC 486: 480V AC
	LED	Transformer	APS1③DN②	A, G, PW, R, S, W, Y	
		DC-DC Converter*	APS116DDN②		
Square (Marking) UPQS1B (Plastic Bezel)  	Without Lamp	Full Voltage	UPQS1B99N②	A, G, R, S, W, Y	
	LED	Transformer	UPQS1B③DN②	A, G, PW, R, S, W, Y	
		Incandescent	Transformer	UPQS1B③N②	
Square (Marking) UPQMS1B (Metal Bezel)  	Without Lamp	Full Voltage	UPQMS1B99N②	A, G, R, S, W, Y	
	LED	Transformer	UPQMS1B③DN②	A, G, PW, R, S, W, Y	
		Incandescent	Transformer	UPQMS1B③N②	A, G, R, S, W
Rectangular (Marking) UPQS4B (Plastic Bezel)  	Without Lamp	Full Voltage	UPQS4B99N②	A, G, R, S, W	
	Incandescent	Transformer	UPQS4B③N②		
Push-to-Check APS1*PN  	Without Lamp	Full Voltage	APS199PN②	A, C, G, R, S, W	
	Incandescent	Transformer	APS1③PN②		

- Color Code
Specify a lens/LED color code in place of ② in the Type No.
A: amber, C: clear, G: green, PW: pure white, R: red, S: white, W: white, Y: yellow
- Specify an operating voltage code in place of ③ in the Type No.
- Full voltage types do not contain a lamp. Order LED or incandescent lamps separately. For lamps, see page 35.
- LED illuminated transformer and DC-DC converter types contain an LED lamp (LSTD-6②, rated voltage 6V AC/DC).
- Incandescent illuminated transformer types contain an incandescent lamp (LS-6, rated voltage 6V AC/DC).
- Round bezel (metal): Chrome-plated
Square bezel (plastic): Black
Square bezel (metal): Chrome-plated
- * DC-DC converter types are not approved by UL, CSA, and TÜV, and not CE compliant (operating voltage 90 to 140V DC).
- The lamp of push-to-check pilot light is not connected to the contact terminal. To connect, refer to the circuit diagram example below.

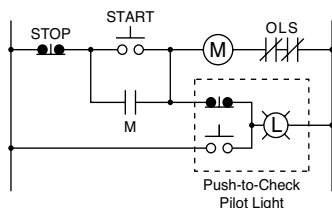

ø25 TWS Series Pilot Lights

Dimensions

• Dome APS1

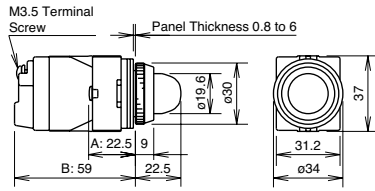

A: Full voltage type
B: Transformer type

• Square (Marking Type) UPQS1B (Plastic Bezel)

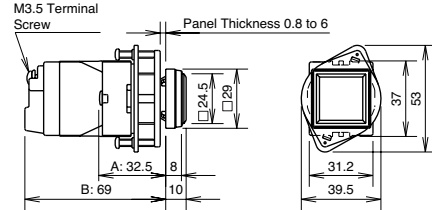

Marking Plate Size: □21.2×11 mm, 2 plates included

A: Full voltage type
B: Transformer type

• Square (Marking Type) UPQMS1B (Metal Bezel)

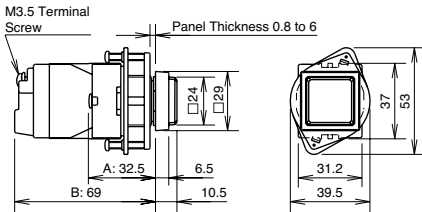

Marking Plate Size: □20×21 mm, 1 plate included

A: Full voltage type
B: Transformer type

• Rectangular (Marking Type) UPQS4B

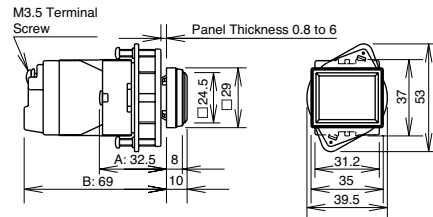

Marking Plate Size: 27.2×21.2×11 mm, 2 plates included

A: Full voltage type
B: Transformer type

• Push-to-Check APS1*PN

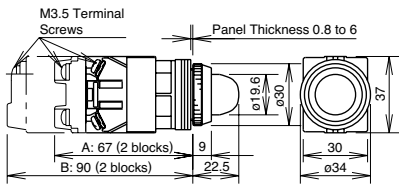

A: Full voltage type
B: Transformer type

All dimensions in mm.

• Terminal Wiring (Bottom View)

Arrows indicate access directions for wiring.

Full Voltage Type

Transformer Type
DC-DC Converter Type

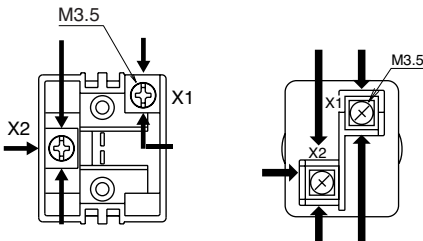

• Panel Mounting of Square and Rectangular Types

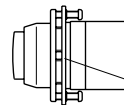

1. Tighten the square or rectangular bezel to the operator and position the ring correctly.
2. Lightly tighten the screw to secure the pilot light onto the panel.



Tighten the screw lightly so that this plate does not bend.

Recommended tightening torque:
0.15 N·m

Round Extended Illuminated Pushbuttons

Shape	Operation Type	Lamp	Input Type	Contact	Type No.		
Round Extended ALS2 AOLS2  	Momentary	Without Lamp	Full Voltage	1NO-1NC	ALS29911N②		
				2NO	ALS29920N②		
				2NO-2NC	ALS29922N②		
				LED	Transformer	1NO-1NC	ALS2③11DN②
						2NO	ALS2③20DN②
						2NO-2NC	ALS2③22DN②
		DC-DC Converter*	1NO-1NC			ALS21611DDN②	
			2NO			ALS21620DDN②	
			2NO-2NC			ALS21622DDN②	
			Incandescent	Transformer	1NO-1NC	ALS2③11N②	
					2NO	ALS2③20N②	
					2NO-2NC	ALS2③22N②	
	Maintained	Without Lamp			Full Voltage	1NO-1NC	AOLS29911N②
						2NO	AOLS29920N②
						2NO-2NC	AOLS29922N②
			LED	Transformer		1NO-1NC	AOLS2③11DN②
						2NO	AOLS2③20DN②
						2NO-2NC	AOLS2③22DN②
		DC-DC Converter*			1NO-1NC	AOLS21611DDN②	
					2NO	AOLS21620DDN②	
					2NO-2NC	AOLS21622DDN②	
			Incandescent	Transformer	1NO-1NC	AOLS2③11N②	
					2NO	AOLS2③20N②	
					2NO-2NC	AOLS2③22N②	



• Color Code and Operating Voltage Code

Without Lamp	LED Illuminated Type	Incandescent Illuminated Type	③ Operating Voltage Code
② Lens Color Code	② Lens/LED Color Code	② Lens Color Code	
Specify a lens color code in place of ② in the Type No.	Specify a lens/LED color code in place of ② in the Type No.	Specify a lens color code in place of ② in the Type No.	Specify an operating voltage code in place of ③ in the Type No.
A: amber C: clear G: green R: red S: blue W: white Y: yellow	A: amber G: green PW: pure white R: red S: blue W: white Y: yellow	A: amber C: clear G: green R: red S: blue W: white	16: 100/110V AC 116: 115V AC 126: 120V AC 26: 200/220V AC 236: 230V AC 246: 240V AC 386: 380V AC 46: 400/440V AC 486: 480V AC

- Full voltage types do not contain a lamp. Order LED or incandescent lamps separately. For lamps, see page 35.
- LED illuminated transformer and DC-DC converter types contain an LED lamp (LSTD-6②, rated voltage 6V AC/DC).
- Incandescent illuminated transformer types contain an incandescent lamp (LS-6, rated voltage 6V AC/DC).
- Round bezel (metal): Chrome-plated
- Other contact arrangements are also available. See page 7.
- * DC-DC converter types are not approved by UL, CSA, and TÜV, and not CE compliant (operating voltage 90 to 140V DC).

ø25 TWS Series Illuminated Pushbuttons

Round Extended with Half Shroud Illuminated Pushbuttons



Shape	Operation Type	Lamp	Input Type	Contact	Type No.		
Round Extended with Half Shroud ALGS2 AOLGS2  	Momentary	Without Lamp	Full Voltage	1NO-1NC	ALGS29911N②		
				2NO	ALGS29920N②		
				2NO-2NC	ALGS29922N②		
				LED	Transformer	1NO-1NC	ALGS2③11DN②
						2NO	ALGS2③20DN②
						2NO-2NC	ALGS2③22DN②
		DC-DC Converter*	Transformer	1NO-1NC	ALGS21611DDN②		
				2NO	ALGS21620DDN②		
				2NO-2NC	ALGS21622DDN②		
		Incandescent	Transformer	1NO-1NC	ALGS2③11N②		
				2NO	ALGS2③20N②		
				2NO-2NC	ALGS2③22N②		
	Maintained			Without Lamp	Full Voltage	1NO-1NC	AOLGS29911DN②
						2NO	AOLGS29920DN②
						2NO-2NC	AOLGS29922DN②
		LED	Transformer			1NO-1NC	AOLGS2③11DN②
						2NO	AOLGS2③20DN②
						2NO-2NC	AOLGS2③22DN②
		DC-DC Converter*	Transformer	1NO-1NC	AOLGS21611DDN②		
				2NO	AOLGS21620DDN②		
				2NO-2NC	AOLGS21622DDN②		
		Incandescent	Transformer	1NO-1NC	AOLGS2③11N②		
				2NO	AOLGS2③20N②		
				2NO-2NC	AOLGS2③22N②		

• Color Code and Operating Voltage Code

Without Lamp	LED Illuminated Type	Incandescent Illuminated Type	③ Operating Voltage Code
② Lens Color Code	② Lens/LED Color Code	② Lens Color Code	
Specify a lens color code in place of ② in the Type No.	Specify a lens/LED color code in place of ② in the Type No.	Specify a lens color code in place of ② in the Type No.	Specify an operating voltage code in place of ③ in the Type No.
A: amber C: clear G: green R: red S: blue W: white Y: yellow	A: amber G: green PW: pure white R: red S: blue W: white Y: yellow	A: amber C: clear G: green R: red S: blue W: white	16: 100/110V AC 116: 115V AC 126: 120V AC 26: 200/220V AC 236: 230V AC 246: 240V AC 386: 380V AC 46: 400/440V AC 486: 480V AC

- Full voltage types do not contain a lamp. Order LED or incandescent lamps separately. For lamps, see page 35.
- LED illuminated transformer and DC-DC converter types contain an LED lamp (LSTD-6②, rated voltage 6V AC/DC).
- Incandescent illuminated transformer types contain an incandescent lamp (LS-6, rated voltage 6V AC/DC).
- Round bezel (metal): Chrome-plated
- Other contact arrangements are also available. See page 7.
- * DC-DC converter types are not approved by UL, CSA, and TÜV, and not CE compliant (operating voltage 90 to 140V DC).

Round Extended with Full Shroud Illuminated Pushbuttons

Shape	Operation Type	Lamp	Input Type	Contact	Type No.		
Round Extended with Full Shroud ALFS2 AOLFS2  	Momentary	Without Lamp	Full Voltage	1NO-1NC	ALFS29911N②		
				2NO	ALFS29920N②		
				2NO-2NC	ALFS29922N②		
				LED	Transformer	1NO-1NC	ALFS2③11DN②
						2NO	ALFS2③20DN②
						2NO-2NC	ALFS2③22DN②
		DC-DC Converter*	1NO-1NC			ALFS21611DDN②	
			2NO			ALFS21620DDN②	
			2NO-2NC			ALFS21622DDN②	
			Incandescent	Transformer	1NO-1NC	ALFS2③11N②	
					2NO	ALFS2③20N②	
					2NO-2NC	ALFS2③22N②	
	Maintained	Without Lamp			Full Voltage	1NO-1NC	AOLFS29911N②
						2NO	AOLFS29920N②
						2NO-2NC	AOLFS29922N②
			LED	Transformer		1NO-1NC	AOLFS2③11DN②
						2NO	AOLFS2③20DN②
						2NO-2NC	AOLFS2③22DN②
		DC-DC Converter*			1NO-1NC	AOLFS21611DDN②	
					2NO	AOLFS21620DDN②	
					2NO-2NC	AOLFS21622DDN②	
			Incandescent	Transformer	1NO-1NC	AOLFS2③11N②	
					2NO	AOLFS2③20N②	
					2NO-2NC	AOLFS2③22N②	





• Color Code and Operating Voltage Code

Without Lamp	LED Illuminated Type	Incandescent Illuminated Type	③ Operating Voltage Code
② Lens Color Code	② Lens/LED Color Code	② Lens Color Code	
Specify a lens color code in place of ② in the Type No. A: amber C: clear G: green R: red S: blue W: white Y: yellow	Specify a lens/LED color code in place of ② in the Type No. A: amber G: green PW: pure white R: red S: blue W: white Y: yellow	Specify a lens color code in place of ② in the Type No. A: amber C: clear G: green R: red S: blue W: white	Specify an operating voltage code in place of ③ in the Type No. 16: 100/110V AC 116: 115V AC 126: 120V AC 26: 200/220V AC 236: 230V AC 246: 240V AC 386: 380V AC 46: 400/440V AC 486: 480V AC

- Full voltage types do not contain a lamp. Order LED or incandescent lamps separately. For lamps, see page 35.
- LED illuminated transformer and DC-DC converter types contain an LED lamp (LSTD-6②, rated voltage 6V AC/DC).
- Incandescent illuminated transformer types contain an incandescent lamp (LS-6, rated voltage 6V AC/DC).
- Round bezel (metal): Chrome-plated
- Other contact arrangements are also available. See page 7.
- * DC-DC converter types are not approved by UL, CSA, and TÜV, and not CE compliant (operating voltage 90 to 140V DC).

ø25 TWS Series Illuminated Pushbuttons

Mushroom / Mushroom Pushlock Turn Reset Illuminated Pushbuttons

Shape	Operation Type	Lamp	Input Type	Contact	Type No.
ø35mm Mushroom ALS3 AOLS3  	Momentary	Without Lamp	Full Voltage	1NO-1NC	ALS39911N②
				2NO	ALS39920N②
				2NO-2NC	ALS39922N②
		Incandescent	Transformer	1NO-1NC	ALS3③11N②
				2NO	ALS3③20N②
				2NO-2NC	ALS3③22N②
	Maintained	Without Lamp	Full Voltage	1NO-1NC	AOLS39911N②
				2NO	AOLS39920N②
				2NO-2NC	AOLS39922N②
		Incandescent	Transformer	1NO-1NC	AOLS3③11N②
				2NO	AOLS3③20N②
				2NO-2NC	AOLS3③22N②
Mushroom Pushlock Turn Reset AVLS3  		Without Lamp	Full Voltage	1NO-1NC	AVLS39911NR
				2NO	AVLS39920NR
				2NO-2NC	AVLS39922NR
		LED	Transformer	1NO-1NC	AVLS3③11DNR
				2NO	AVLS3③20DNR
				2NO-2NC	AVLS3③22DNR
	Incandescent	Transformer	1NO-1NC	AVLS3③11NR	
			2NO	AVLS3③20NR	
			2NO-2NC	AVLS3③22NR	

• Color Code and Operating Voltage Code

Without Lamp / LED Illuminated Type	Incandescent Illuminated Type	③ Operating Voltage Code
② Lens/LED Color Code	② Lens Color Code	
Specify a lens/LED color code in place of ② in the Type No. A: amber G: green R: red S: blue W: white	Specify a lens color code in place of ② in the Type No. A: amber G: green R: red S: blue W: white	Specify an operating voltage code in place of ③ in the Type No. 16: 100/110V AC 116: 115V AC 126: 120V AC 26: 200/220V AC 236: 230V AC 246: 240V AC 386: 380V AC 46: 400/440V AC 486: 480V AC

• Full voltage types do not contain a lamp. Order LED or incandescent lamps separately. For lamps, see page 35.

• LED illuminated transformer types contain an LED lamp (LSTD-6②, rated voltage 6V AC/DC).

• Incandescent illuminated transformer types contain an incandescent lamp (LS-6, rated voltage 6V AC/DC).



• Round bezel (metal): Chrome-plated

• Other contact arrangements are also available. See page 7.

• **Pushlock Turn Reset:** Lens is maintained when pressed and is reset when turned clockwise. Red lens only.

Note: AVLS3 pushlock turn reset switches cannot be used as emergency stop switches. When emergency stop switches are required, use XW or HW series emergency stop switches (ISO 13850 and IEC 60947-5-5 compliant).

Square Flush Pushbuttons

Shape	Operation Type	Lamp	Input Type	Contact	Type No.
Square Flush (Marking) ULQS1B UOLQS1B  	Momentary	Without Lamp	Full Voltage	1NO-1NC	ULQS1B9911N②
				2NO	ULQS1B9920N②
				2NO-2NC	ULQS1B9922N②
		LED	Transformer	1NO-1NC	ULQS1B③11DN②
				2NO	ULQS1B③20DN②
				2NO-2NC	ULQS1B③22DN②
		Incandescent	Transformer	1NO-1NC	ULQS1B③11N②
				2NO	ULQS1B③20N②
				2NO-2NC	ULQS1B③22N②
	Maintained	Without Lamp	Full Voltage	1NO-1NC	UOLQS1B9911N②
				2NO	UOLQS1B9920N②
				2NO-2NC	UOLQS1B9922N②
		LED	Transformer	1NO-1NC	UOLQS1B③11DN②
				2NO	UOLQS1B③20DN②
				2NO-2NC	UOLQS1B③22DN②
		Incandescent	Transformer	1NO-1NC	UOLQS1B③11N②
				2NO	UOLQS1B③20N②
				2NO-2NC	UOLQS1B③22N②

• **Color Code and Operating Voltage Code**

Without Lamp	LED Illuminated Type	Incandescent Illuminated Type	③ Operating Voltage Code
② Lens Color Code	② Lens/LED Color Code	② Lens Color Code	
Specify a lens color code in place of ② in the Type No. A: amber G: green R: red S: blue W: white Y: yellow	Specify a lens/LED color code in place of ② in the Type No. A: amber G: green PW: pure white R: red S: blue W: white Y: yellow	Specify a lens color code in place of ② in the Type No. A: amber G: green R: red S: blue W: white	Specify an operating voltage code in place of ③ in the Type No. 16: 100/110V AC 116: 115V AC 126: 120V AC 26: 200/220V AC 236: 230V AC 246: 240V AC 386: 380V AC 46: 400/440V AC 486: 480V AC

- Full voltage types do not contain a lamp. Order LED or incandescent lamps separately. For lamps, see page 35.
- LED illuminated transformer types contain an LED lamp (LSTD-6②, rated voltage 6V AC/DC).
- Incandescent illuminated transformer types contain an incandescent lamp (LS-6, rated voltage 6V AC/DC).
- Square bezel (plastic): Black
- Other contact arrangements are also available. See page 7.

Ø25 TWS Series Illuminated Pushbuttons

Dimensions

• Round Extended ALS2 / AOLS2

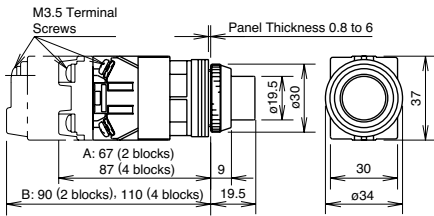

A: Full voltage type
B: Transformer type

• Round Extended with Half Shroud ALGS2 / AOLGS2

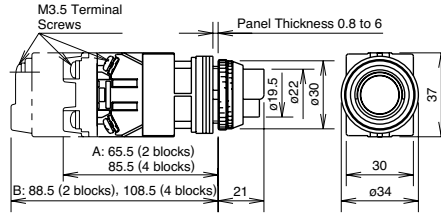

A: Full voltage type
B: Transformer type

• Round Extended with Full Shroud ALFS2 / AOLFS2

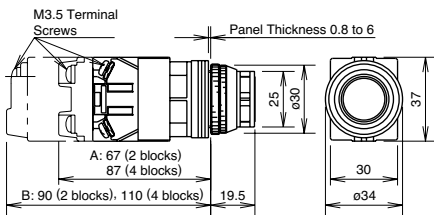

A: Full voltage type
B: Transformer type

• Ø35mm Mushroom ALS3 / AOLS3

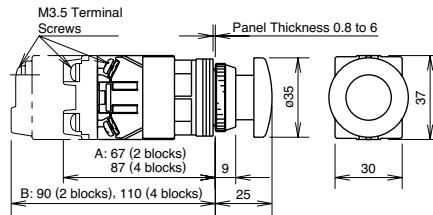

A: Full voltage type
B: Transformer type

• Mushroom Pushlock Turn Reset AVLS3

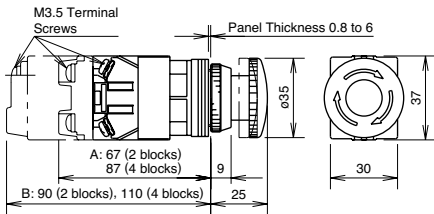

A: Full voltage type
B: Transformer type

• Square Flush ULQS1B / UOLQS1B

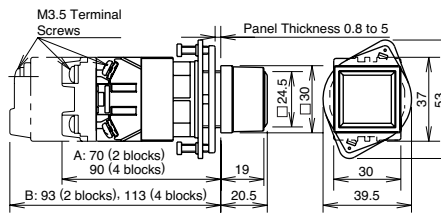

Marking Plate Size: □21.2x11 mm, 2 plates included

A: Full voltage type
B: Transformer type

All dimensions in mm.

ø25 TWS Series Selector Switches

Selector Switches (Lever Operator Type)

No. of Positions	Shape			Contact Arrangement Chart							
	Contact Code	Contact Block Mounting Position	Operator Position Type	L	R	Maintained	Spring Return from Right	Spring Return from Left	—		
90° 2-position	10 (1NO)	1	NO	●		ASS2L10N	ASS21L10N	ASS22L10N *	—		
		2	Dummy						—		
	11 (1NO-1NC)	1	NO	●	●	ASS2L11N	ASS21L11N	ASS22L11N *	—		
		2	NC	●					—		
	20 (2NO)	1	NO	●	●	ASS2L20N	ASS21L20N	ASS22L20N *	—		
		2	NO	●					—		
	22 (2NO-2NC)	1	NO	●	●	ASS2L22N	ASS21L22N	ASS22L22N *	—		
		2	NC	●					—		
		3	NO		●				—		
	2R ★ (1NO-1NC)	1	NO	●	●	ASS2L2RN-118 ★	ASS21L2RN-118 ★	—	—		
2		NC	●					—			
2R ★ (1NO-1NC)	1	NC	●	●	—	—	ASS22L2RN-169 ★	—			
	2	NO	●					—			
45° 3-position	20 (2NO)	1	NO	●		ASS3L20N	ASS31L20N	ASS32L20N	ASS33L20N		
		2	NO		●						
	02 (2NC)	1	NC	●	●	ASS3L02N	ASS31L02N	ASS32L02N	ASS33L02N		
		2	NC	●							
	22 (2NO-2NC)	1	NO	●	●	ASS3L22N	ASS31L22N	ASS32L22N	ASS33L22N		
		2	NO	●							
		3	NC	●	●						
		4	NC	●							
	40 (4NO)	1	NO	●	●	ASS3L40N	ASS31L40N	ASS32L40N	ASS33L40N		
		2	NO	●							
		3	NO	●	●						
		4	NO	●							
	04 (4NC)	1	NC	●	●	ASS3L04N	ASS31L04N	ASS32L04N	ASS33L04N		
		2	NC	●							
		3	NC	●	●						
		4	NC	●							
	3S ★	1	NO	●	●	ASS3L3SN-243 ★	—	—	—		
		2	NO	●							
3		NC	●	●							
4		Dummy									
30° 5-position / 45° 4-position	4S ★	1	NC	●	●	ASS4L4SN-407 ★	—				
		2	NC	●							
		3	NC	●	●						
		4	NO	●							
	4S ★	1	NO	●	●	ASS4L4SN-411 ★	—				
		2	NC	●							
		3	NC	●	●						
	3S ★	1	NO	●	●	ASS4L3SN-461 ★	—				
		2	NC	●							
		3	NC	●	●						
		4	Dummy								
	4S ★	1	NO	●	●	—	ASS5L4SN-501 ★				
2		NC	●								
3		NC	●	●							
4		NO	●								

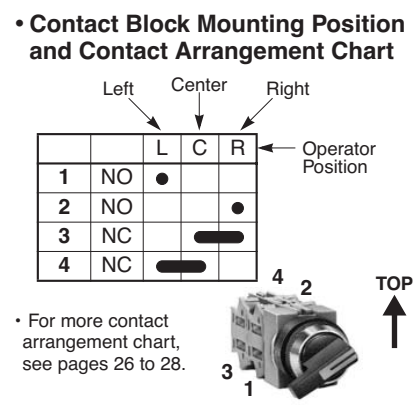

• On the 2-position selector switches marked with * above, the contact operation is reversed as follows.

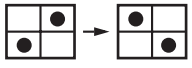

- On the contact arrangement marked with ★ in the table above, the rated current (load switching current) is reduced to a half of the rated current of the contact block. The rated insulation voltage and the rated thermal current remain unchanged.
- Selector switches with one or three contact blocks contain a dummy block.
- Lever operator: White indicator on black lever

Key Selector Switches

No. of Positions	Shape			ASS*K						
	Contact Arrangement Chart									
90° 2-position	Contact Code	Contact Block		Operator Position			Maintained	Spring Return from Right	Spring Return from Left	—
		Mounting Position	Type	L	R					
	10 (1NO)	1	NO		●		ASS2K10N	ASS21K10N	ASS22K10N *	—
		2	Dummy							
	11 (1NO-1NC)	1	NO		●		ASS2K11N	ASS21K11N	ASS22K11N *	
		2	NC	●						
	20 (2NO)	1	NO		●		ASS2K20N	ASS21K20N	ASS22K20N *	
		2	NO		●					
	22 (2NO-2NC)	1	NO		●		ASS2K22N	ASS21K22N	ASS22K22N *	
		2	NC	●						
		3	NO		●					
	2R ★ (1NO-1NC)	1	NO	■			ASS2K2RN-118 ★	ASS21K2RN-118 ★	—	
2		NC		■						
2R ★ (1NO-1NC)	1	NC		■		—	—	ASS22K2RN-169 ★		
	2	NO	■							
45° 3-position	Contact Code	Contact Block		Operator Position			Maintained	Spring Return from Right	Spring Return from Left	Spring Return Two-way
		Mounting Position	Type	L	C	R				
	20 (2NO)	1	NO	●			ASS3K20N	ASS31K20N	ASS32K20N	ASS33K20N
		2	NO			●				
	02 (2NC)	1	NC			■	ASS3K02N	ASS31K02N	ASS32K02N	ASS33K02N
		2	NC	■						
	22 (2NO-2NC)	1	NO	●			ASS3K22N	ASS31K22N	ASS32K22N	ASS33K22N
		2	NO			●				
		3	NC			■				
		4	NC	■						
	40 (4NO)	1	NO	●			ASS3K40N	ASS31K40N	ASS32K40N	ASS33K40N
		2	NO			●				
3		NO	●							
4		NO			●					
04 (4NC)	1	NC			■	ASS3K04N	ASS31K04N	ASS32K04N	ASS33K04N	
	2	NC	■							
	3	NC			■					
	4	NC	■							
3S ★	1	NO	●			ASS3K3SN-243 ★	—	—	—	
	2	NO			●					
	3	NC			■					
	4	Dummy								

• On the spring-returned types, the key can be released only from the maintained position. On the maintained types, the key can be released from every position. Key retained positions are also available. See page 8.

• On the 2-position selector switches marked with * above, the contact operation is reversed as follows.

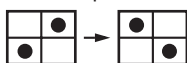

• On the contact arrangement marked with ★ in the table above, the rated current (load switching current) is reduced to a half of the rated current of the contact block. The rated insulation voltage and the rated thermal current remain unchanged.

• Key selector switches with one or three contact blocks contain a dummy block.

• Cylinder cover: Black

Round bezel (Metal): Chrome-plated

Contact Block Mounting Position and Contact Arrangement Chart

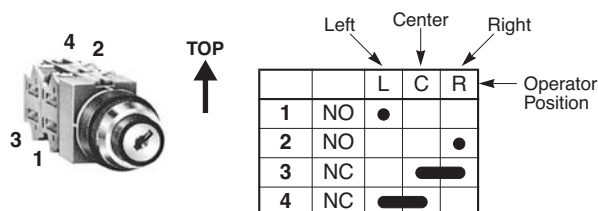

• For more contact arrangement chart, see pages 26 to 28.

ø25 TWS Series Illuminated Selector Switches

Illuminated Selector Switches

90° 2-position

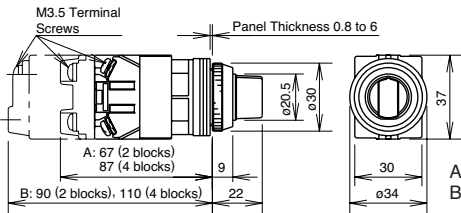
Shape		ASLS							
 CE, UL, SF, A									
		Contact Arrangement Chart		Lamp	Input Type	Maintained	Spring Return from Right	Spring Return from Left	
Contact Code	Contact Block	Operator Position							
	Mounting Position	Type	L	R					
11 (1NO-1NC)	1	NO		●	Without Lamp	Full Voltage	ASLS29911N②	ASLS219911N②	ASLS229911N② *
	2	NC	●		LED	Transformer	ASLS2③11DN②	ASLS21③11DN②	ASLS22③11DN② *
					Incandescent	Transformer	ASLS2③11N②	ASLS21③11N②	ASLS22③11N② *
20 (2NO)	1	NO		●	Without Lamp	Full Voltage	ASLS29920N②	ASLS219920N②	ASLS229920N② *
	2	NO		●	LED	Transformer	ASLS2③20DN②	ASLS21③20DN②	ASLS22③20DN② *
					Incandescent	Transformer	ASLS2③20N②	ASLS21③20N②	ASLS22③20N② *
22 (2NO-2NC)	1	NO		●	Without Lamp	Full Voltage	ASLS29922N②	ASLS219922N②	ASLS229922N② *
	2	NC	●						
	3	NO		●	LED	Transformer	ASLS2③22DN②	ASLS21③22DN②	ASLS22③22DN② *
	4	NC	●						
					Incandescent	Transformer	ASLS2③22N②	ASLS21③22N②	ASLS22③22N② *

• Color Code and Operating Voltage Code

Without Lamp / LED Illuminated Type	Incandescent Illuminated Type	③ Operating Voltage Code
② Lens/LED Color Code	② Lens Color Code	
Specify a lens/LED color code in place of ② in the Type No.	Specify a lens color code in place of ② in the Type No.	Specify an operating voltage code in place of ③ in the Type No.
A: amber G: green R: red S: blue W: white Y: yellow	A: amber G: green R: red S: blue W: white	16: 100/110V AC 156: 115V AC 136: 120V AC 26: 200/220V AC 236: 230V AC 256: 240V AC 386: 380V AC 46: 400/440V AC 486: 480V AC

• On the selector switches marked with * above, the contact operation is reversed as follows.

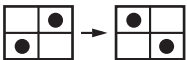

- Full voltage types do not contain a lamp. Order LED or incandescent lamps separately. For lamps, see page 35.
- LED illuminated transformer types contain an LED lamp (LSTD-6②, rated voltage 6V AC/DC).
- Incandescent illuminated transformer types contain an incandescent lamp (LS-6, rated voltage 6V AC/DC).
- Round bezel (Metal): Chrome-plated

• Contact Block Mounting Position and Contact Arrangement Chart

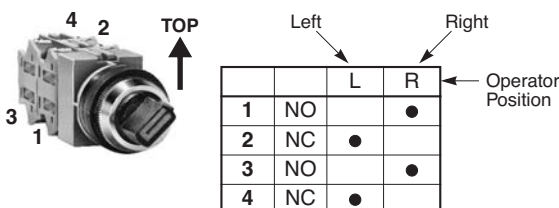

• For more contact arrangement chart, see pages 26 to 28.

Illuminated Selector Switches

45° 3-position

Contact Code	Contact Block		Operator Position			Lamp Input Type	Maintained	Spring Return from Right	Spring Return from left	Spring Return Two-way
	Mounting Position	Type	L	C	R					
20 (2NO)	1	NO	●			Without Lamp Full Voltage	ASLS39920N②	ASLS319920N②	ASLS329920N②	ASLS339920N②
	2	NO			●	LED Transformer	ASLS3③20DN②	ASLS31③20DN②	ASLS32③20DN②	ASLS33③20DN②
						Incandescent Transformer	ASLS3③20N②	ASLS31③20N②	ASLS32③20N②	ASLS33③20N②
02 (2NC)	1	NC		■		Without Lamp Full Voltage	ASLS39902N②	ASLS319902N②	ASLS329902N②	ASLS339902N②
	2	NC	■			LED Transformer	ASLS3③02DN②	ASLS31③02DN②	ASLS32③02DN②	ASLS33③02DN②
						Incandescent Transformer	ASLS3③02N②	ASLS31③02N②	ASLS32③02N②	ASLS33③02N②
22 (2NO-2NC)	1	NO	●			Without Lamp Full Voltage	ASLS39922N②	ASLS319922N②	ASLS329922N②	ASLS339922N②
	2	NO			●	Without Lamp Full Voltage	ASLS39922N②	ASLS319922N②	ASLS329922N②	ASLS339922N②
	3	NC		■		LED Transformer	ASLS3③22DN②	ASLS31③22DN②	ASLS32③22DN②	ASLS33③22DN②
	4	NC	■			LED Transformer	ASLS3③22DN②	ASLS31③22DN②	ASLS32③22DN②	ASLS33③22DN②
					Incandescent Transformer	ASLS3③22N②	ASLS31③22N②	ASLS32③22N②	ASLS33③22N②	
40 (4NO)	1	NO	●			Without Lamp Full Voltage	ASLS39940N②	ASLS319940N②	ASLS329940N②	ASLS339940N②
	2	NO			●	Without Lamp Full Voltage	ASLS39940N②	ASLS319940N②	ASLS329940N②	ASLS339940N②
	3	NO	●			LED Transformer	ASLS3③40DN②	ASLS31③40DN②	ASLS32③40DN②	ASLS33③40DN②
	4	NO			●	LED Transformer	ASLS3③40DN②	ASLS31③40DN②	ASLS32③40DN②	ASLS33③40DN②
					Incandescent Transformer	ASLS3③40N②	ASLS31③40N②	ASLS32③40N②	ASLS33③40N②	
04 (4NC)	1	NC		■		Without Lamp Full Voltage	ASLS39904N②	ASLS319904N②	ASLS329904N②	ASLS339904N②
	2	NC	■			Without Lamp Full Voltage	ASLS39904N②	ASLS319904N②	ASLS329904N②	ASLS339904N②
	3	NC		■		LED Transformer	ASLS3③04DN②	ASLS31③04DN②	ASLS32③04DN②	ASLS33③04DN②
	4	NC	■			LED Transformer	ASLS3③04DN②	ASLS31③04DN②	ASLS32③04DN②	ASLS33③04DN②
					Incandescent Transformer	ASLS3③04N②	ASLS31③04N②	ASLS32③04N②	ASLS33③04N②	

• Color Code and Operating Voltage Code

Without Lamp / LED Illuminated Type	Incandescent Illuminated Type	③ Operating Voltage Code
② Lens/LED Color Code	② Lens Color Code	
Specify a lens/LED color code in place of ② in the Type No. A: amber G: green R: red S: blue W: white Y: yellow	Specify a lens color code in place of ② in the Type No. A: amber G: green R: red S: blue W: white	Specify an operating voltage code in place of ③ in the Type No. 16: 100/110V AC 156: 115V AC 136: 120V AC 26: 200/220V AC 236: 230V AC 256: 240V AC 386: 380V AC 46: 400/440V AC 486: 480V AC

- Full voltage types do not contain a lamp. Order LED or incandescent lamps separately. For lamps, see page 35.
- LED illuminated transformer types contain an LED lamp (LSTD-6②, rated voltage 6V AC/DC).
- Incandescent illuminated transformer types contain an incandescent lamp (LS-6, rated voltage 6V AC/DC).
- Round bezel (Metal): Chrome-plated

• Contact Block Mounting Position and Contact Arrangement Chart

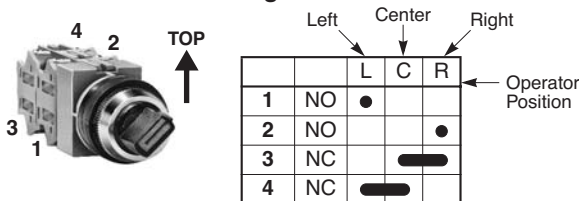

• For more contact arrangement chart, see pages 26 to 28.

ø25 TWS Series Selector Switch Contact Arrangement Charts

90° 2-position (Maintained / Spring Return)

Positions				Maintained	Spring Return from Right	Spring Return from Left		
Operator Types				Knob, Lever, Key, Illuminated				
Contact Code	Circuit No.	Mounting Position	Type	Operator Positions				
				L	R	L	R	
10 (1NO)	—	1	NO		●	●		
		2	Dummy					
01 (1NC)	—	1	NC	●			●	
		2	Dummy					
11 (1NO-1NC)	—	1	NO		●	●		
		2	NC	●			●	
		103	1	NC	●			●
			2	NO		●	●	
20 (2NO)	—	1	NO		●	●		
		2	NO		●	●		
02 (2NC)	—	1	NC	●			●	
		2	NC	●			●	
22 (2NO-2NC)	—	1	NO		●	●		
		2	NC	●			●	
		3	NO		●	●		
		4	NC	●			●	
	110	1	NC	●			●	
		2	NO		●	●		
		3	NC	●			●	
		4	NO		●	●		
	111	1	NO		●	●		
		2	NO		●	●		
		3	NC	●			●	
		4	NC	●			●	
	117	1	NC	●			●	
		2	NO		●	●		
		3	NO		●	●		
		4	NC	●			●	
31 (3NO-1NC)	107	1	NC	●			●	
		2	NO		●	●		
		3	NO		●	●		
		4	NO		●	●		
40 (4NO)	—	1	NO		●	●		
		2	NO		●	●		
		3	NO		●	●		
		4	NO		●	●		
2R ★	118 ★	1	NO		—————			
		2	NC	—————				
	168 ★	1	NO			—————		
		2	NC	—————				
	119 ★	1	NC	—————				
		2	NO		—————			
	169 ★	1	NC			—————		
		2	NO	—————				
4R ★	120 ★	1	NO		—————			
		2	NC	—————				
		3	NO		—————			
		4	NC	—————				
	170 ★	1	NO			—————		
		2	NC	—————				
		3	NO		—————			
		4	NC	—————				
	121 ★	1	NC	—————				
		2	NO		—————			
		3	NC	—————				
		4	NO		—————			
171 ★	1	NC			—————			
	2	NO	—————					
	3	NC	—————					
	4	NO		—————				

• Contact Block Mounting Position and Contact Arrangement Chart



		L	R
1	NO		●
2	NC	●	
3	NO		●
4	NC	●	

← Operator Position

• On the contact arrangement marked with ★ in the table, the rated current (load switching current) is reduced to a half of the rated current of the contact block. The rated insulation voltage and the rated thermal current remain unchanged.

Type No. Development

• When circuit number is not required:

ASS 2 11 N
 Contact Code (1NO-1NC)
 2-position

• When circuit number is required:

ASS 2 11 N - 103
 Circuit No.
 Contact Code (1NO-1NC)
 2-position

TWS Series Selector Switch Contact Arrangement Charts ø25

45° 3-position (Maintained / Spring Return)

Positions	Maintained	Spring Return from Right	Spring Return from Left	Spring Return Two-way
Operator Types	Knob, Lever, Key, Illuminated			

Contact Code	Circuit No.	Mounting Position	Type	Operator Positions			
				L	C	R	
11 (1NO-1NC)	202	1	NO	●			
		2	NC	■			
	203	1	NC		■		
		2	NO			●	
	302	1	NO	●		●	
		2	NC	■			
303	1	NC		●			
	2	NO			●		
20 (2NC)	—	1	NO	●			
		2	NO			●	
301	—	1	NO			●	
		2	NO			●	
02 (2NC)	—	1	NC		■		
		2	NC	■			
		304	1	NC		●	
		2	NC	■			
22 (2NO-2NC)	—	1	NO	●			
		2	NO			●	
		3	NC		■		
		4	NC	■			
	210	—	1	NC		■	
			2	NO			●
			3	NC		■	
			4	NO			●
	308	—	1	NO	●		●
			2	NC	■		
			3	NO	●		●
			4	NC	■		
309	—	1	NO	●		●	
		2	NC	■			
		3	NC		●		
		4	NO			●	
310	—	1	NC		●		
		2	NO			●	
		3	NC		●		
		4	NO			●	
31 (3NO-1NC)	206	1	NO	●			
		2	NC	■			
		3	NO	●			
		4	NO			●	
207	—	1	NC		■		
		2	NO			●	
		3	NO	●			
		4	NO			●	
13 (1NC-3NC)	212	1	NO	●			
		2	NC	■			
		3	NC		■		
		4	NC	■			
	313	—	1	NC		●	
			2	NO			●
			3	NC		●	
			4	NC	■		

Contact Code	Circuit No.	Mounting Position	Type	Operator Positions			
				L	C	R	
40 (4NO)	—	1	NO	●			
		2	NO			●	
		3	NO	●			
		4	NO			●	
	305	—	1	NO	●		●
			2	NO			●
			3	NO	●		●
			4	NO			●
04 (4NC)	—	1	NC		■		
		2	NC	■			
		3	NC		■		
		4	NC	■			
	314	—	1	NC		●	
			2	NC	■		
			3	NC		●	
			4	NC	■		

• Contact Block Mounting Position and Contact Arrangement Chart

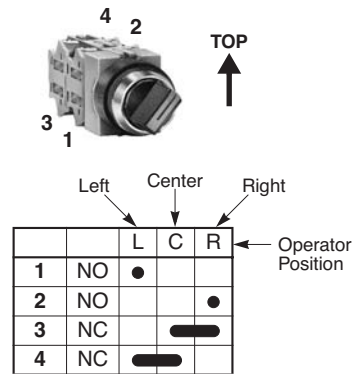

Type No. Development

- When circuit number is not required:

ASS 3 22 N

— Contact Code (2NO-2NC)
— 3-position

- When circuit number is required:

ASS 3 22 N - 210

— Circuit No.
— Contact Code (2NO-2NC)
— 3-position

ø25 TWS Series Selector Switch Contact Arrangement Charts

45° 3-position (Maintained)

Positions				Maintained			
Operator Types				Knob, Lever, Illuminated			
Contact Code	Circuit No.	Mounting Position	Type	Operator Positions			
				L	C	R	
3S★	243★	1	NO	●			
		2	NO			●	
		3	NC		●		
		4	Dummy				
4S★	233★	1	NO	●			
		2	NC	■			
		3	NO	●		●	
		4	NO			●	
	234★	1	NO	●			
		2	NC	■			
		3	NC		●		
		4	NC	■			
	235★	1	NC		■		
		2	NO				●
		3	NC		●		
		4	NO				●
237★	1	NO	●				
	2	NO				●	
	3	NC		●			
	4	NO				●	
240★	1	NC		■			
	2	NC	■				
	3	NC		●			
	4	NO				●	

45° 4-position (Maintained)

Positions				Maintained			
Operator Types				Knob, Lever			
Contact Code	Circuit No.	Mounting Position	Type	Operator Positions			
				1	2	3	4
3S★	461★	1	NO	●			
		2	NC		●		
		3	NC			●	
		4	Dummy				
4S★	405★	1	NC		■		
		2	NC		●		
		3	NC			●	
		4	NC	■			
	407★	1	NC		■		
		2	NC		●		
		3	NC			●	
		4	NO				●
	409★	1	NO	●			
		2	NC		●		
		3	NC				●
		4	NC	■			
411★	1	NO	●				
	2	NC		●			
	3	NC				●	
	4	NO				●	

30° 5-position (Maintained)

Positions				Maintained				
Operator Types				Knob, Lever				
Contact Code	Circuit No.	Mounting Position	Type	Operator Positions				
				1	2	3	4	5
4S★	501★	1	NO	●				
		2	NC		●			
		3	NC				●	
		4	NO					●

• Contact Block Mounting Position and Contact Arrangement Chart

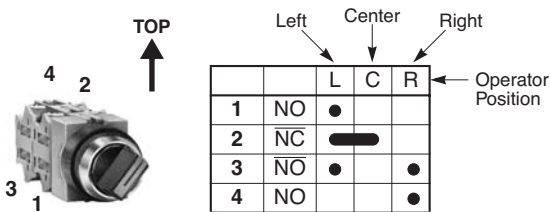

• On the contact arrangement marked with ★ in the table, the rated current (load switching current) is reduced to a half of the rated current of the contact block. The rated insulation voltage and the rated thermal current remain unchanged.

Type No. Development

• When circuit number is not required:

ASS 3 4S N











└─ Contact Code
└─ 3-position

• When circuit number is required:

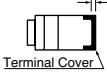
ASS 3 4S N - 233

└─ Circuit No.
└─ Contact Code (2NO-2NC)
└─ 3-position

Terminal Covers

Terminal Cover	TW-VLC	HW-VL3	HW-VL5	APS-PVL	Use of terminal covers increases the depth by the dimensions below.
 44.6H × 14.1W	 37.8H × 26W	 39.1H × 15.5W	 36H × 29.4W	 <small>Terminal Cover</small>	
Control Unit					
<ul style="list-style-type: none"> • Pilot light APS UPQS UPQMS 	Full Voltage			X	+6 mm
	Transformer DC-DC Converter		X		+3 mm
<ul style="list-style-type: none"> • Pushbutton ABS AOS ABGS AOGS ABFS AOFS AKS AVS AJS AZS ATS UTS AYS • Selector switch ASS 	1 contact block 	X			+3.5 mm
	2 contact blocks 	X 2 pieces			
	3 contact blocks 	X 2 pieces			
	4 contact blocks 	X 2 pieces			
<ul style="list-style-type: none"> • Illuminated pushbutton ALS AOLFS AOLS ULOS ALGS UOLQS AOLGS AVLS ALFS ATLS • Illuminated selector switch ASLS • Push-to-check pilot light APS 	Full Voltage 			X	+3 mm
	Transformer DC-DC Converter 		X		

• Ordering Terminal Covers

Terminal covers are ordered separately.
When ordering terminal covers, specify the Type No. and required quantity.

ø25 TWS Series Accessories and Replacement Parts

Nameplates

NSA, NSALO, and NFSO

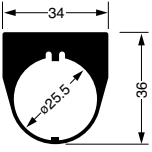
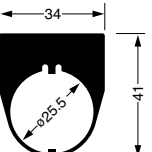
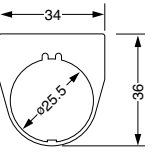
Dimensions (mm)	Legend	Material	Type No.	Ordering Type No.	Package Quantity	Description
	Blank	Aluminium 0.8 mm thick	NSA-0	NSA-0	1	• Black
				NSA-0PN10	10	
	With Legend		NSA-*	NSA-*	1	• White letters on black background
				NSA-*PN10	10	
	Blank	Aluminium 0.8 mm thick	NSALO	NSALO	1	• Black
				NSALOPN10	10	
	Blank	Stainless steel 0.8 mm thick	NFSO	NFSO	1	• Stainless steel ground color
				NFSOPN10	10	

• Specify a legend code in place of * in the Ordering Type No.







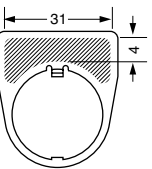
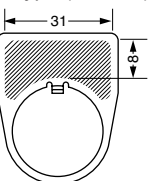



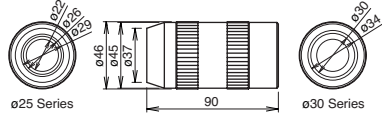

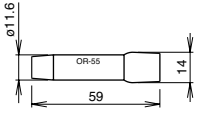
Legends

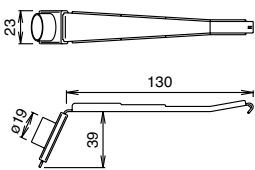
Code	Legend
0	(blank)
1	ON
2	OFF
3	START
4	STOP
31	OFF-ON
35	HAND-AUTO
53	HAND-OFF-AUTO

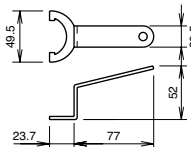
Example of Shape and Engraving Area

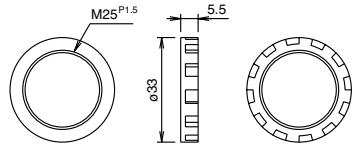
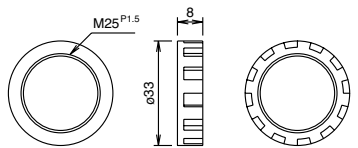

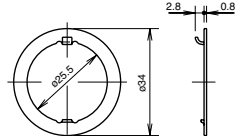

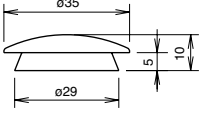



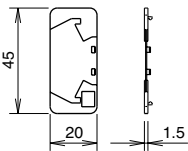

Shape	Engraving Area		Max. No. of Lines	No. of Letters on 1 Line
	Height	Width		
Standard Type (NSA/NFSO) 	4	31	1	17
Mushroom Type (NSALO) 	8	31	2	17

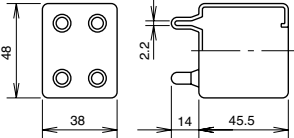
- The above example is when the letter is 3 mm tall.
- Engraving must be made within 1.5 mm from the sides.

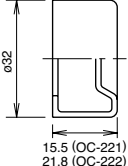
Accessories					
Shape	Material	Type No.	Ordering Type No.	Package Quantity	Dimensions (mm)
	Rubber	OR-12	OR-12	1	<ul style="list-style-type: none"> Used to tighten the round bezel when installing the TWS control unit onto a panel. 
	Rubber	OR-55	OR-55	1	<ul style="list-style-type: none"> Used to install and remove LED/incandescent lamps. 
	Metal/ Rubber	TW-KC1	TW-KC1	1	<ul style="list-style-type: none"> Used to remove contact blocks, transformers, lenses and adapters. 
	Metal	TWST-T1	TWST-T1	1	<ul style="list-style-type: none"> Used to tighten the locking ring on the square control units. 
	Pushbutton Illuminated Pushbutton	OG-RT1	OG-RT1PN02	2	<ul style="list-style-type: none"> Used to attach square pushbuttons and illuminated pushbuttons on to the panel. Mounting centers are the same as round control units. 
	Pilot Light	OG-RT2	OG-RT2PN02	2	<ul style="list-style-type: none"> Used to attach pilot lights on to the panel. Mounting centers are the same as round control units. 
	Metal	OGL-21	OGL-21PN10	10	<ul style="list-style-type: none"> Used to prevent the operator from rotating. Generally used when using no nameplates on selector switches. 
	Rubber (black)	OBS-13B	OBS-13BPN05	5	<ul style="list-style-type: none"> Used to plug unused ø25.5mm mounting holes. 

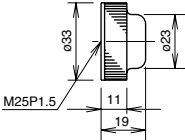

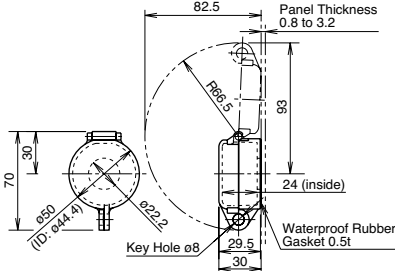

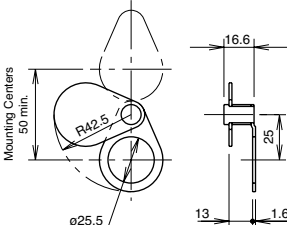
ø25 TWS Series Accessories and Replacement Parts

Accessories

Shape	Material	Type No.	Ordering Type No.	Package Quantity	Dimensions (mm)
	Plastic	HW-VL1	HW-VL1PN10	10	<ul style="list-style-type: none"> Used to prevent contact between adjacent lead wires when units are mounted closely. Barriers should be always used in close mounting. 
 <p>For 1 layer of contact blocks (2 contact blocks)</p>	Rubber (nitril) Black	OCS-99	OCS-99	1	<ul style="list-style-type: none"> Dust cover boot used for pushbuttons and selector switches. Temperature range: -5 to +60°C Black 
 <p>For flush pushbuttons</p>	Rubber (EPDM)	OC-221	OC-221	1	<ul style="list-style-type: none"> Used to cover and protect pushbuttons where units are subject to water splash. Not suitable for outdoor use or where the units are subject to oil splash. 
<p>For extended pushbuttons</p>		OC-222	OC-222	1	
	Rubber (nitril)	OCS-11①	OCS-11①	1	<ul style="list-style-type: none"> B (black), G (green), R (red), Y (yellow) Metallic bezels covered with rubber boot to enhance waterproof and oiltight characteristics. Button is installed in the cover. Remove the button from the pushbutton before using the button cover. Temperature range: -5 to +60°C 
	Polyarylate (gasket: nitril rubber)	OLS-KL1	OLS-KL1	1	<ul style="list-style-type: none"> Used to protect momentary and maintained pushbuttons, illuminated pushbuttons, knob selector switches, and key selector switches. 
	Metal	OLS-C	OLS-C	1	<ul style="list-style-type: none"> Used to protect flush buttons from inadvertent operation. Can be easily attached under the round bezel. 

Note: Specify a button cover color code in place of ① in the Ordering Type No.

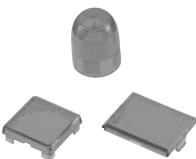







Maintenance Parts

Shape	Material	Type No.	Ordering Type No.	Package Quantity	Color Code		
	Plastic	Pushbutton Pilot Light	OGP-22①	OGP-22①PN02	2	B (black), G (green), R (red), Y (yellow), W (white) • Cannot be used for control units with half shroud or full shroud.	
		Selector Switch	OGP-33①	OGP-33①PN02			
	Metal (chrome-plated)	Plastic	Pushbutton Pilot Light	OG-22	OG-22PN02	1	• Cannot be used for control units with half shroud or full shroud.
			Selector Switch	OG-33	OG-33PN02		
		Pushbutton with Full Shroud	ABS2FN	ABS2FN			
		Mushroom with Full Shroud	ABS3GN	ABS3GN			
		Pushbutton, Illuminated Pushbutton with Half Shroud	ALS1G	ALS1G			
		Illuminated Pushbutton with Full Shroud	ALS1F	ALS1F			
	Plastic	Flush	ABS1BN-①	ABS1BN-①PN05	5	B (black), G (green), R (red), S (blue), Y (yellow), W (white) • Light color	
		Extended	ABS2BN-①	ABS2BN-①PN05			
		ø35mm Mushroom	ABS3BN-①	ABS3BN-①PN02	2		
		Square Flush	Plastic	UBQS1BN-①	UBQS1BN-①PN02	2	B (black), G (green), R (red), S (blue), Y (yellow) • Light color
		Square Extended		UBQS2BN-①	UBQS2BN-①PN02		
		Pushlock Turn Reset		AVS3BN-①	AVS3BN-①PN02		
		Push-Pull		AYS3BN-①	AYS3BN-①PN02		
			Plastic	Dome	APS106L-②	APS106L-②PN05	5
APS106LD-②	APS106LD-②PN05						
For Square Metal Bezel Unit	UPQS306L-②			UPQS306L-②PN05		C (clear), G (green), R (red), S (blue) A (amber), Y (yellow)	
	UPQS306LD-②			UPQS306LD-②PN05			
Rectangular	UPQS406L-②			UPQS406L-②PN05		A (amber), C (clear), G (green), R (red), S (blue)	
	Plastic			For Square Type with Plastic Bezel	UPQS106L-②	UPQS106L-②PN05	
		UPQS106LD-②	UPQS106LD-②PN05		5	A (amber), Y (yellow)	
	Plastic	Extended	ALS06L-②	ALS06L-②PN05	5	C (clear), G (green), R (red), S (blue) A (amber), Y (yellow), W (white)	
			ALS06LD-②	ALS06LD-②PN05			
		Mushroom	ALS3L-②	ALS3L-②PN02	2	G (green), R (red), S (blue) A (amber), W (white)	
			ALS3LD-②	ALS3LD-②PN02			
		Pushlock Turn Reset	AVLS3L-R	AVLS3L-RPN02			

Note: Specify a button color code or lens color code in place of ① or ② in the Ordering Type No.
 Use a clear lens for white or pure white illumination.



ø25 TWS Series Accessories and Replacement Parts

Maintenance Parts





Shape		Material	Type No.	Ordering Type No.	Package Quantity	Remarks
	Knob	Plastic	ASSHHY-①	ASSHHY-①PN02	2	B (black), G (green), R (red)
	Lever		ASSHHL-①	ASSHHL-①PN02		
	Color Insert		TWS-HC1①	TWS-HC1①PN05	5	B (black), G (green), R (red), S (blue), Y (yellow), W (white)
	Illuminated Selector	Plastic	ASLSLDY-②	ASLSLDY-②	1	G (green), R (red), S (blue)
ASLSDDY-②			ASLSDDY-②	A (amber), W (white), Y (yellow)		
Cap for Key Selector		Plastic	AKS2B-①	AKS2B-①PN05	5	B (black), R (red)
Clear Button Cover		Plastic	ABS1B-C	ASB1B-CPN05	5	B (black), G (green), R (red), W (white), Y (yellow) • Used on flush pushbuttons to indicate a mark or a symbol engraved on the marking plate. The clear button cover holds the marking plate.
Marking Plate		Plastic	TWS-0①	TWS-0①PN10	10	
	For Square Pilot Lights and Illuminated Pushbuttons	Plastic	UPQS106P-W	UPQS106P-WPN02	2	• □21.2 × 11 mm
	For Square Pilot Lights with Metal Bezel		UPQS306N-W	UPQS306N-WPN02		• □20 × 21 mm
	Rectangular Pilot Lights		UPQS406P-W	UPQS406P-WPN02		• 27.2 × 21.2 × 11 mm
	1NO		HW-C10	HW-C10	1	• Housing: Blue Push rod: Green
	1NC		HW-C01	HW-C01		• Housing: Purple red Push rod: Red
	Early Make		HW-C10R	HW-C10R		• Housing: Blue Push rod: Black
	Late Break		HW-C01R	HW-C01R		• Housing: Purple red Push rod: White
Dummy Block			TW-DB	TW-DBPN10	10	• Used for non-illuminated units with 1NO or 1NC contact blocks.
Full Voltage Adapter			TW-DA1B	TW-DA1BPN02	2	• Adapter with M3.5 screws used for illuminated pushbutton or illuminated selector switch. Snaps on to the back of the contact block.
	For Key Selector Switch	Metal	TW-SK-0	TW-SK-0PN02	2	
	3.0-mm thick	Rubber	OW-22	OW-22PN10	10	• Outside diameter: ø33.8 • Inside diameter: ø25.5
	1.5-mm thick		OW-21	OW-21PN10		

Maintenance Parts

LED Lamps (LSTD Type)

Operating Voltage	Current Draw		Type No.	Ordering Type No.	Illumination Color Code	Package Quantity	Base
	AC	DC					
6V AC/DC ±10% 	17 mA (A, R, W, Y) 8 mA (G, PW, S)	14 mA (A, R, W, Y) 5.5 mA (G, PW, S)	LSTD-6②	LSTD-6②	Specify a color code in place of ② in the Ordering Type No. A: amber G: green PW: pure white R: red S: blue W: white Y: yellow	1	BA9S/13
				LSTD-6②PN10		10	
12V AC/DC ±10% 	11 mA	10 mA	LSTD-1②	LSTD-1②	1		
				LSTD-1②PN10	10		
24V AC/DC ±10% 	11 mA	10 mA	LSTD-2②	LSTD-2②	1		
				LSTD-2②PN10	10		

Incandescent Lamps (LS Type)

Rated Operating Voltage	Lamp Ratings	Type No.	Package Quantity
6V AC/DC 	1W (6.3V)	LS-6	1
12V AC/DC 	1W (18V)	LS-8	
18V AC/DC 	1W (24V)	LS-2	
24V AC/DC 	1W (30V)	LS-3	

Transformer

Shape	Primary Voltage	Secondary Voltage	Type No.
Transformer Unit 	100/110V AC	5.5V	TW-T16B
	120V AC		TW-T126B
	200/220V AC		TW-T26B
	240V AC		TW-T246B

Safety Precautions

- Turn off the power to the TWS series control units before starting installation, removal, wiring, maintenance, and inspection of the products. Failure to turn power off may cause electrical shocks or fire hazard.
- To avoid a burn on your hand, use the lamp holder tool when replacing lamps.
- For wiring, use wires of a proper size to meet the voltage and current requirements. Tighten the M3.5 terminal screws to a tightening torque of 1.0 to 1.3 N·m. Failure to tighten terminal screws may cause overheat and fire.

- Use HW-C type contact blocks for the TWS series. Do not replace with or add conventional TW series contact blocks. Using a different type of contact block may lead to malfunction.

HW-C Type Contact Block

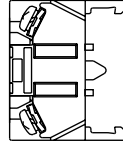

TW Type Contact Block

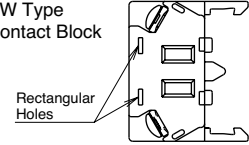

Instructions

• Installation of Selector Operators

1. The shaft of each selector or illuminated selector switch has a recess to identify in which direction to install the operator. Align the operator with the recess and press in the operator.
2. Press color insert (non-illuminated type) into the operator. The color insert retains the operator.

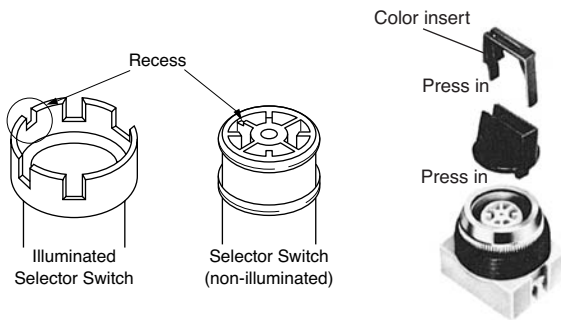

• Removing the Operator

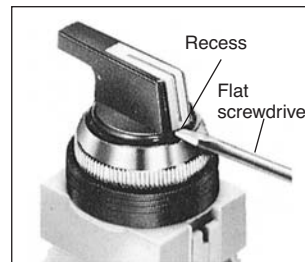

1. Removing the Color Insert

Insert a flat screwdriver (4.5mm wide at maximum) into the recess of the color insert. Turn the screwdriver to push out the insert from the operator.

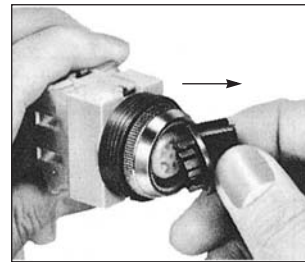

2. Removing the Operator (Non-illuminated)

Push the operator sideways as shown in the left photo to remove the operator.

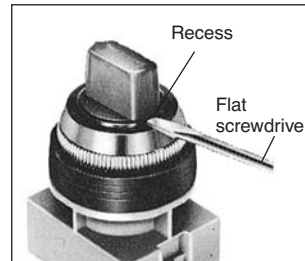

3. Removing the Operator (Illuminated)

Insert a flat screwdriver into the recess of the operator and turn the screwdriver to remove the operator.

• Standard Position

2-Position, 90°	3-Position, 45°	4-Position, 45°	5-Position, 30°

[Example]

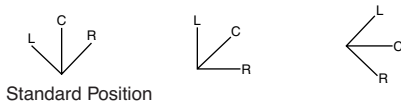

Standard Position

The non-illuminated operators can be installed in positions other than the standard position as shown above.

Removing Contact Blocks, Transformers, and Full Voltage Adapters

Insert the end of the contact block removal tool into the snap-fit latch of the contact block (or transformer, full voltage adapter) and pull the tool as shown on the right.

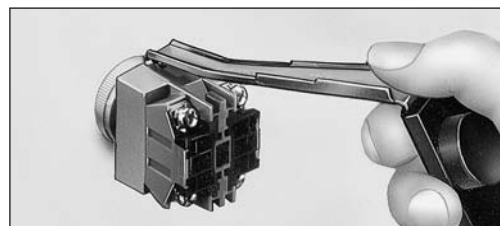

Instructions

Installing Lenses

• **Lens Structure and Marking Plate**

All square lens units are marking types. To engrave on the marking plate, remove the marking plate from the lens.

Square Pilot Lens

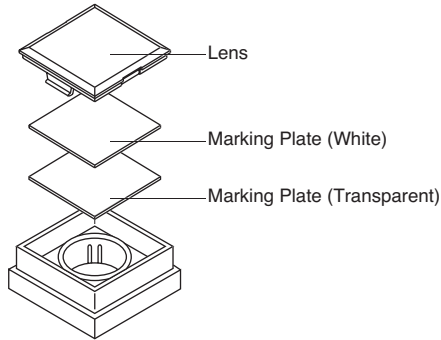

Square Illuminated Pushbutton

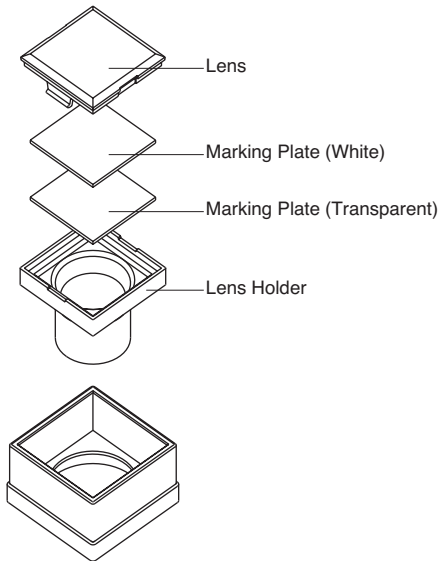

Collective Mounting

When mounting the units closely in a horizontal row on 34mm centers, use optional barriers to prevent interconnection between adjoining terminals. The barriers can be attached simply by pressing them onto the sides of contact blocks.

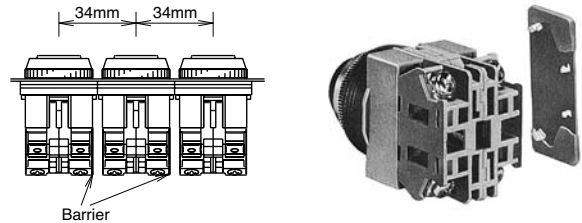

Tightening Torque

Tighten the M3.5 terminal screws to a torque of 1.0 to 1.3 N·m.

Replacement of Lamps

Lamps can be replaced by using the lamp holder tool (OR-55) from the front of the panel.

- **How to remove**
To remove, slip the lamp holder tool onto the lamp head lightly. Then push slightly, and turn the lamp holder tool counterclockwise.
- **How to install**
To install, insert the lamp head into the lamp holder tool. Place the pins on the lamp base to the grooves in the lamp socket. Insert the lamp and turn it clockwise.



Instructions

Panel Thickness and Rubber Washer

Adjust the thickness of the rubber washers according to the panel thickness. Also, make sure to include the nameplate thickness when using a nameplate.

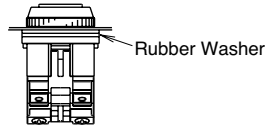

Applicable Models

- Momentary Type Pushbutton (Excluding Extended with Half Shroud, Extended with Full Shroud, and Square Type)
- Round Pilot Light (APS1)

Panel Thickness (mm)	Rubber Washer	
	1.5 mm	3.0 mm
Supplied	2 pieces	1 piece
0.8 to 2.5	2 pieces	1 piece
2.5 to 4.0	1 piece	1 piece
4.0 to 5.5	—	1 piece
5.5 to 6.0	1 piece	—

Applicable Models

- Momentary Type Pushbutton with Half Shroud (ABGS2)

Panel Thickness (mm)	Rubber Washer	
	1.5 mm	3.0 mm
Supplied	1 piece	1 piece
0.8	1 piece	1 piece
0.8 to 2.3	—	1 piece
2.3 to 3.8	1 piece	—

Applicable Models

- Maintained Type Extended Pushbutton with Half Shroud (AOGS2)
- Momentary Type Illuminated Pushbutton with Half Shroud (ALGS2)
- Maintained Type Illuminated Pushbutton with Half Shroud (AOLGS2)

Panel Thickness (mm)	Rubber Washer	
	1.5 mm	3.0 mm
Supplied	2 pieces	1 piece
0.8	2 pieces	1 piece
0.8 to 2.3	1 piece	1 piece
2.3 to 3.8	—	1 piece
3.8 to 5.3	1 piece	—

Applicable Models

- Momentary Type Extended Pushbutton with Full Shroud (ABFS2)

Panel Thickness (mm)	Rubber Washer	
	1.5 mm	3.0 mm
Supplied	3 pieces	1 piece
0.8 to 1.5	3 pieces	1 piece
1.5 to 3	2 pieces	1 piece
3.0 to 4.5	1 piece	1 piece
4.5 to 6	—	1 piece

Applicable Models

- Maintained Type Extended Pushbutton with Full Shroud (AOFS2)

Panel Thickness (mm)	Rubber Washer	
	1.5 mm	3.0 mm
Supplied	4 pieces	1 piece
0.8 to 1.5	4 pieces	1 piece
1.5 to 3.0	3 pieces	1 piece
3.0 to 4.5	2 pieces	1 piece
4.5 to 6.0	1 piece	1 piece

Applicable Models

- Other Models (Excluding Square Types)

Panel Thickness (mm)	Rubber Washer	
	1.5 mm	3.0 mm
Supplied	3 pieces	1 piece
0.8 to 2.5	3 pieces	1 piece
2.5 to 4.0	2 pieces	1 piece
4.0 to 5.5	1 piece	1 piece
5.5 to 6.0	—	1 piece

Installation of LED Illuminated Units

- Note the polarity for wiring when connecting to DC-DC converter unit.

Terminal No.	Polarity
X1	Positive
X2	Negative

- Transformer type units are recommended for use in areas subjected to noise.

3. Notes for Pure White LED Lamps

- Do not use the pure white LED outdoors, otherwise it will lead to the degradation of brightness and color. Do not remove or apply shock to the cap on the pure white LED lamp, otherwise it may break or damage the cap.
- For the pure white LED, use a white lens. The illumination color will be dull if a different color is used.

Notes on LED Illuminated Units

LED lamps consist of semiconductors. If the applied voltage exceeds the rated voltage, LED elements may deteriorate due to overheat, resulting in significant decrease in luminance, hue change, or failure of lighting. Also, if an extraneous noise, transient voltage, or transient current is applied to the circuit, similar effects may occur. When using LED lamps, observe the following instructions.

• Rated Voltage

The LED lamps are rated at 6V, 12V, or 24V AC/DC, and can be used within $\pm 10\%$ the rated voltage of either AC or DC.

• DC Power

- Switching power supply
Regulated voltage from switching power supply is best suited. Make sure to use within the rated voltage of the LED lamp.
- Rechargeable battery
Note that the battery voltage may exceed the rated voltage of the LED lamp while the battery is being charged and immediately after the charging is complete. Be sure to use the LED lamp on a voltage of $\pm 10\%$ the rated voltage.
- Full-wave rectification
Since the LED lamp is AC/DC compatible, a diode bridge for rectification is not necessary. If the LED lamp is used on a full-wave rectification current through a diode bridge, the rectifier diodes will reduce the voltage, resulting in lower luminance.
- Single-phase half-wave rectification
This is not suitable for the power source of LED lamps. Use constant-voltage DC power.

• Noise

LED elements deteriorate due to extraneous noise, resulting in significant decrease in luminance, hue change, or failure of lighting. When such effects are anticipated, take a protection measure shown below, such as RC elements or a surge absorber.

[Protection Example 1] For AC circuit

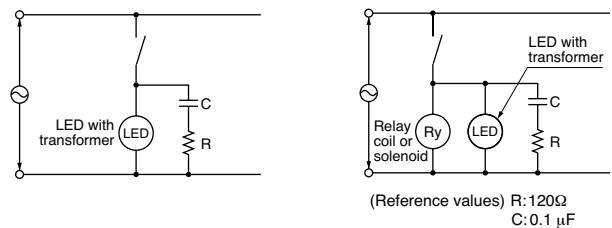

[Protection Example 2] For DC circuit

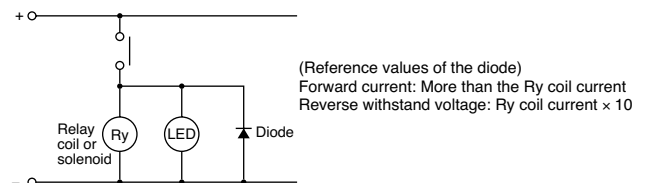

• Countermeasures against Dim Lighting

- Leakage currents through the transistors or a contact protection circuit may cause the LED lamp to illuminate dimly even when the output is off.
- When the LED lamp is illuminated by a transistor output, take the following measure.

[Circuit Example]

Connect shunt resistor R in parallel with the LED lamp.

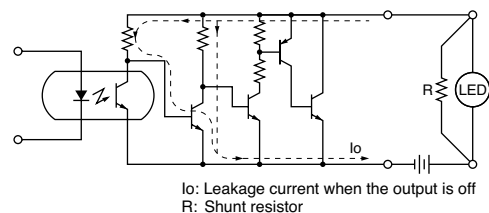



IDEC IZUMI CORPORATION

7-31, Nishi-Miyahara 1-Chome, Yodogawa-ku, Osaka 532-8550, Japan
Tel: +81-6-6398-2571, Fax: +81-6-6392-9731
www.idec.com

IDEC CORPORATION (USA)

1175 Elko Drive, Sunnyvale, CA 94089-2209, USA
Tel: +1-408-747-0550, Toll Free: (800) 262-IDECC, Fax: +1-408-744-9055
E-mail: opencontact@idec.com, www.idec.com

IDEC CANADA LIMITED

Unit 22-151, Brunel Road Mississauga, Ontario, L4Z 1X3, Canada
Tel: +1-905-890-8561, Toll Free: (888) 317-4332, Fax: +1-905-890-8562

IDEC ELECTRONICS LIMITED

Unit 2, Beechwood, Chineham Business Park, Basingstoke, Hampshire
RG24 8WA, UK
Tel: +44-1256-321000, Fax: +44-1256-327755
E-mail: idec@uk.idec.com

IDEC ELEKTROTECHNIK GmbH

Wendenstrasse 331, D-20537 Hamburg, Germany
Tel: +49-40-25 30 54 10, Fax: +49-40-25 30 54 24
E-mail: service@idec.de, www.idec.de

IDEC AUSTRALIA PTY. LTD.

2/3 Macro Court, Rowville, Victoria 3178, Australia
Toll Free: 1-800-68-4332, Fax: +61-3-9763-3255
E-mail: sales@au.idec.com

IDEC IZUMI ASIA PTE. LTD.

No. 31, Tannery Lane #05-01, Dragon Land Building, Singapore 347788
Tel: +65-6746-1155, Fax: +65-6844-5995
E-mail: generalinfo@idecasia.com.sg

IDEC IZUMI (H.K.) CO., LTD.

Unit 1505-07, DCH Commercial Centre No. 25, Westlands Road,
Quarry Bay, Hong Kong
Tel: +852-2803-8989, Fax: +852-2565-0171
E-mail: idec@idechk.com

IDEC IZUMI (Shanghai) Co., Ltd.

Room E, 15F, Majesty Building, No. 138 Pudong Avenue,
Shanghai 200120, P.R.C.
Tel: +86-21-5887-9181, Fax: +86-21-5887-8930
E-mail: idec@cn.idec.com

IDEC TAIWAN CORPORATION

8F, No. 79, Hsin Tai Wu Road, Sec. 1, Hsi-Chih, Taipei County, Taiwan
Tel: +886-2-2698-3929, Fax: +886-2-2698-3931
E-mail: service@idectwn.com.tw

Specifications and other descriptions in this catalog are subject to change without notice.

Mouser Electronics

Authorized Distributor

Click to View Pricing, Inventory, Delivery & Lifecycle Information:

IDEC:

[ASS44SN-411](#) [ASS4L4SN-411](#) [ASLS212620DN-S](#) [ASLS22620DN-S](#) [ASLS313622DN-G](#) [ASS3K00N-RL](#)
[ASLS31620N-G](#) [ASS201N](#) [UBQS111N-B](#) [UBQS210N-Y](#) [UBQS211N-G](#) [UBQS211N-R](#) [UPQS106L-A](#) [UPQS106L-W](#)
[UPQS106LD-A](#) [UPQS106LD-Y](#) [UPQS106L-G](#) [UPQS106L-R](#) [UPQS106L-S](#) [UPQS1B126N-G](#) [UPQS1B126N-R](#)
[UPQS4B126N-A](#) [UPQS4B126N-G](#) [ASS4L4SN-407](#) [ASS54SN-501](#) [ASS3102N](#) [AYS3111N-R](#) [UBQS111N-Y](#)
[AOLS22611N-G](#) [AOLS29911N-A-24V](#) [AOLS29911N-G-24V](#) [AOS222N-B](#) [AOS322N-B](#) [AOS322N-R](#) [ASS202N](#)
[ASS210N](#) [ASS2110N](#) [AYS3101N-R](#) [AYS3110N-Y](#) [ASS2111N](#) [ASS211N](#) [ASS220N](#) [ASS221N](#) [ASS2K10N](#)
[ASS2K11N-RR](#) [ASS2L10N](#) [ASS2L11N](#) [ASS300N-B](#) [ASS302N](#) [ASS320N](#) [ASS3220N](#) [ASS3320N-B](#) [ASS33SN-243](#)
[ASS3K11N](#) [ASS3K20N](#) [ASS3L20N-B](#) [UBQS211N-Y](#) [UBQS220N-R](#) [UBQS222N-Y](#) [UPQS106L-C](#) [ASLS22620DN-](#)
[W](#) [UPQS1B126DN-R](#) [UPQS1B22DN-W](#) [AOGS311N-R](#) [ASLS22220DNA](#) [ASLS22220DNG](#) [ASLS22220DNR](#)
[ASLS22220DNY](#) [ASLS222620DNS](#)