

General information

Part number	S41F1C-P12MCCO-200S
Termination	solder
Size	1
Locking principle	push
Coding	1_halfshell
Cable Diameter	cable_mini_20
Cable outlet	bend_relief

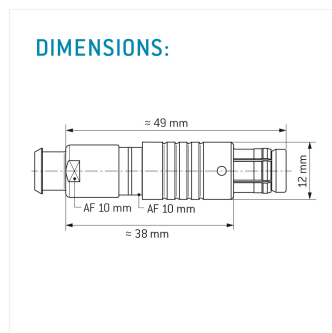

Illustrations may differ from original product.  
Dimensions, unless otherwise specified, in mm.

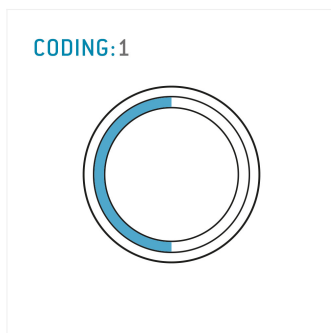

Contact insert description

Number of contacts	12
Contact type	pins
Contact diameter	05mm
Insulator material	peek
Wire cross section	28_awg
Termination	solder
Termination diameter	045mm

reverse\_gender\_on\_request

Technical information

Max. creepage and air clearance distance	05_mm	06_mm
Nominal current single contact	04_a	iec_60512_5_2
Nominal current insert	2,2 A	vde_0298_4
Test voltage	11_kv_ac	sae_13441

safety\_text

## Mechanical and environmental data

Degree of protection*	ip68
-----------------------	------

Operating temperature	40_120_c
-----------------------	----------

Mating cycles	5000
---------------	------

mated

## Material and surface treatments

Housing	m_chrome
---------	----------

Contact	cu_alloy_gold
---------	---------------

safety\_text\_2

ul\_text

illustrative\_text