

### SMD ■ Side View LEDs

### EAPL3809WA1



#### Features

- .Side view white LED.
- .White SMT package.
- .Lead frame package with individual 2 pins.
- .Wide viewing angle
- .Soldering methods: IR reflow soldering
- .Pb-free
- .The product itself will remain within RoHS compliant version.
- .Compliance with EU REACH.
- .Compliance Halogen Free .(Br <900 ppm ,Cl <900 ppm , Br+Cl < 1500 ppm).

#### Description

Due to the package design, EAPL3809WA1 has wide viewing angle, low power consumption and white LEDs are devices which are materialized by combing blue chips and special phosphor. This feature makes the LED ideal for light guide application.

#### Applications

- .Mobile phones.
- .Indicators.
- .Illuminations.
- .Switch lights.

## Device Selection Guide

Chip	Emitted Color	Resin Color
Material		
InGaN	Pure White	Water Clear

## Absolute Maximum Ratings (Ta=25 °C)

Parameter	Symbol	Rating	Unit
Reverse Voltage	$V_R$	5	V
Forward Current	$I_F$	30	mA
Peak Forward Current (Duty 1/10 @10ms)	$I_{FP}$	60	mA
Power Dissipation	$P_d$	110	mW
Operating Temperature	$T_{opr}$	-40 ~ +85	
Storage Temperature	$T_{stg}$	-40 ~ +90	
Soldering Temperature	$T_{sol}$	Reflow Soldering : 260 Hand Soldering : 350	for 10 sec. for 3 sec.

Notes: \*1The products are sensitive to static electricity and must be carefully taken when handling products.

**Electro-Optical Characteristics (Ta=25 )**

Parameter	Symbol	Min.	Typ.	Max.	Unit	Condition
Luminous Flux		5.75	-----	6.50	lm	IF=20mA
Viewing Angle	2 1/2	-----	120	-----	deg	
Forward Voltage	V <sub>F</sub>	2.95	-----	3.45	V	
Reverse Current	I <sub>R</sub>	-----	-----	50	μA	V <sub>R</sub> =5V

**Notes:**

1. Tolerance of Luminous Flux: ± 7%
2. Tolerance of Forward Voltage: ± 0.05V

CONFIDENTIAL

### Bin Range of Luminous Flux

Bin Code	Lm(Min.)	Lm(Max.)	Unit	Condition	Mcd(Min.)	Mcd(Max.)
L57	5.75	6.00	Lm	I <sub>F</sub> =20mA	2055	2145
L60	6.00	6.25			2145	2235
L62	6.25	6.50			2235	2325

**Note:** Tolerance of Luminous Intensity、Luminous Flux: ± 7%

### Bin Range of Forward Voltage

Bin Code	Min.	Max.	Unit	Condition
6-1	2.95	3.05	V	I <sub>F</sub> =20mA
6-2	3.05	3.15		
7-1	3.15	3.25		
7-2	3.25	3.35		
8-1	3.35	3.45		

**Note:** Tolerance of Forward Voltage: ± 0.05V

### Chromaticity Coordinates of Bin Code

Bin Code	CIE_x	CIE_y	Bin Code	CIE_x	CIE_y
NA0-4-1	0.2850	0.2670	NA0-4-2	0.2893	0.2743
	0.2820	0.2720		0.2865	0.2795
	0.2865	0.2795		0.2910	0.2870
	0.2893	0.2743		0.2935	0.2815
NA0-4-3	0.2880	0.2620	NA0-4-4	0.2920	0.2690
	0.2850	0.2670		0.2893	0.2743
	0.2893	0.2743		0.2935	0.2815
	0.2920	0.2690		0.2960	0.2760
NB5-3-1	0.2935	0.2815	NB5-3-2	0.2975	0.2885
	0.2910	0.2870		0.2950	0.2940
	0.2950	0.2940		0.2990	0.3010
	0.2975	0.2885		0.3015	0.2955
NB5-3-3	0.2960	0.2760	NB5-3-4	0.3000	0.2830
	0.2935	0.2815		0.2975	0.2885
	0.2975	0.2885		0.3015	0.2955
	0.3000	0.2830		0.3040	0.2900

**Note:** Tolerance of Chromaticity Coordinates:  $\pm 0.01$

### The C.I.E. 1931 Chromaticity Diagram

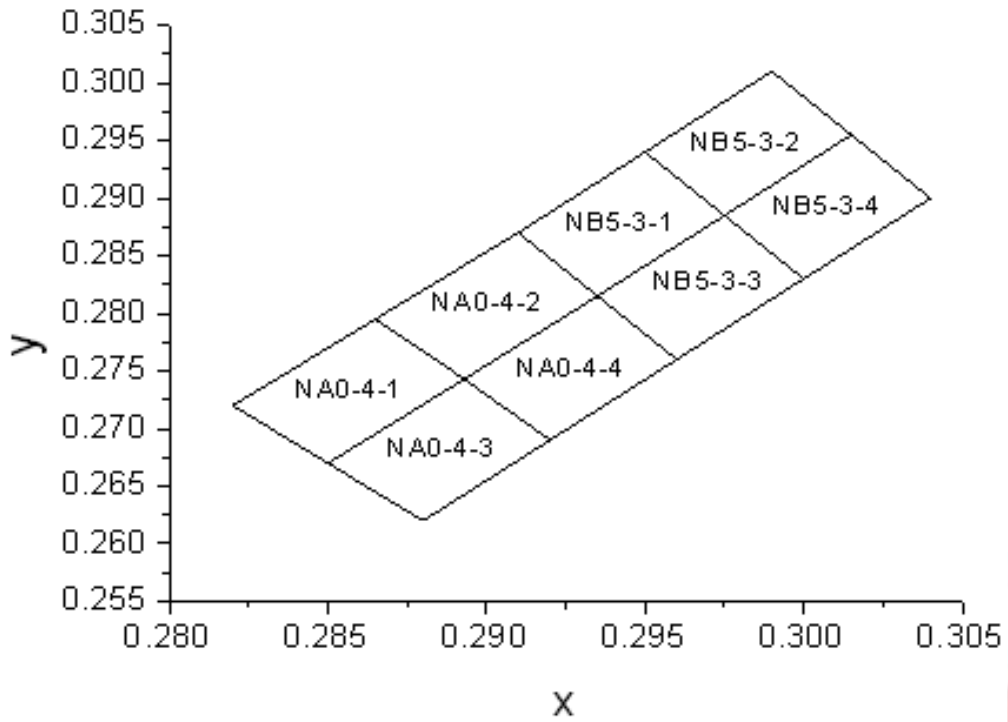

### Package Outline Dimensions

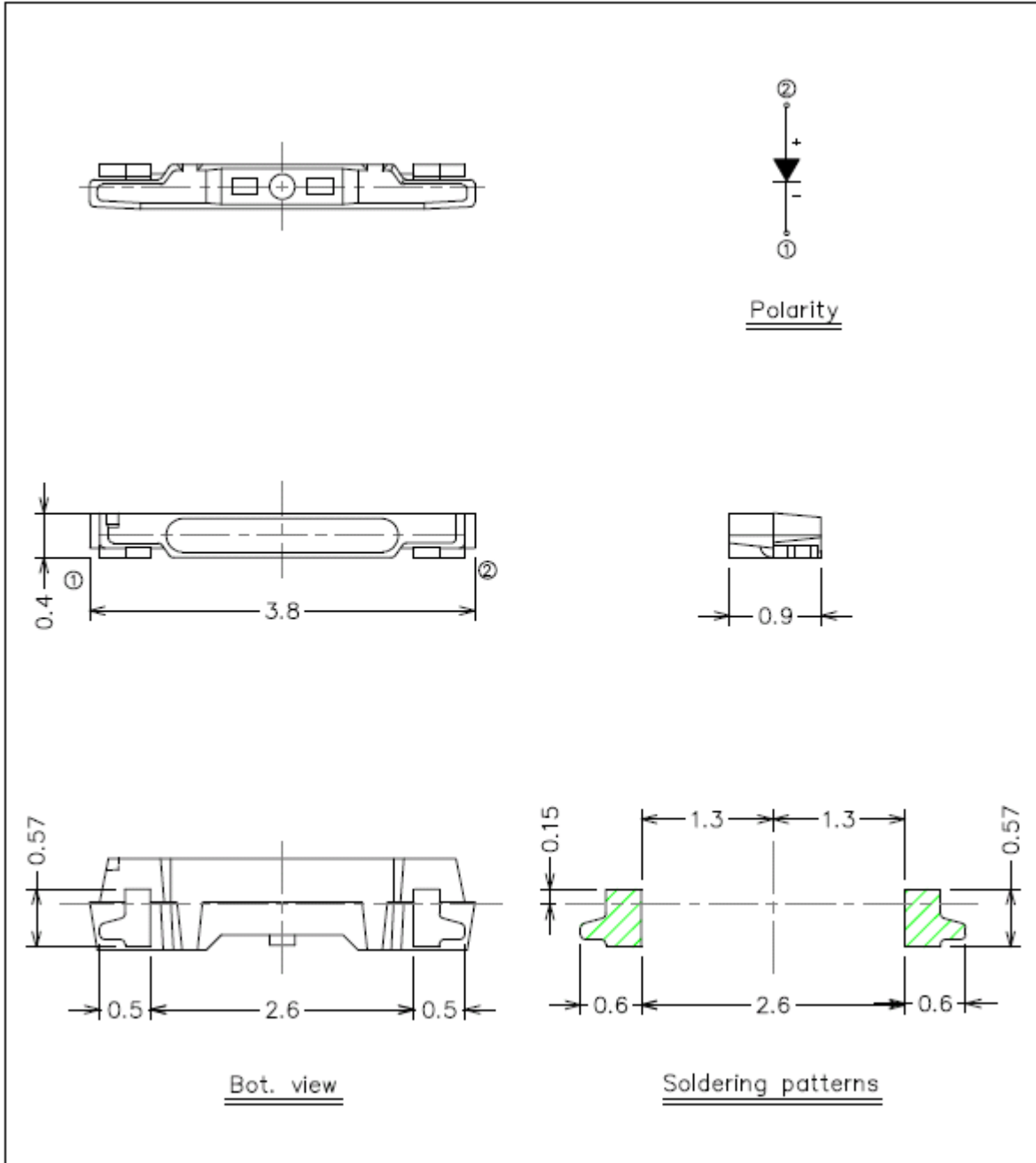

**Note:**

The tolerances unless mentioned is  $\pm 0.1$ mm, Unit = mm.

## Typical Electro-Optical-Thermal Characteristics Curves

1. Spectrum Distribution  
( $T_s=25^\circ\text{C}$ ,  $I_f=20\text{mA}$ )

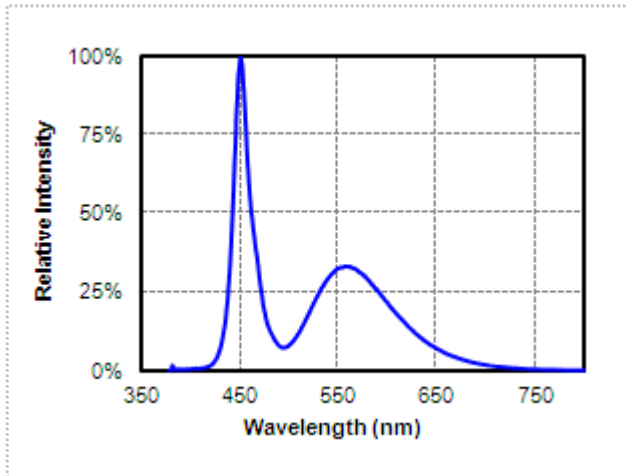

2. Relative Luminous Flux vs. Forward Current  
( $T_s=25^\circ\text{C}$ )

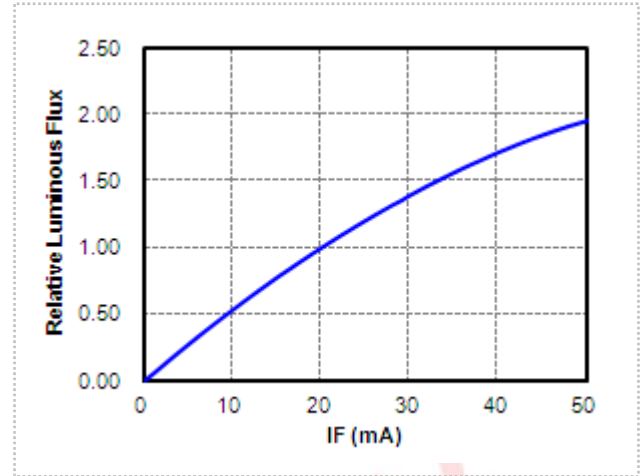

3. Relative Forward Voltage vs. Forward Current  
( $T_s=25^\circ\text{C}$ )

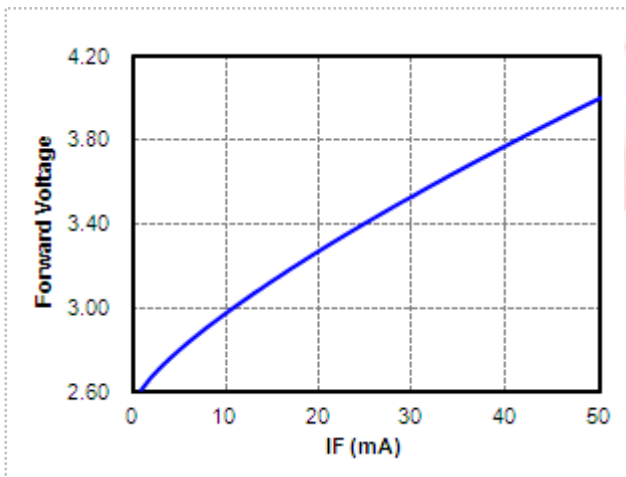

4. Radiation Diagram  
( $T_s=25^\circ\text{C}$ ,  $I_f=20\text{mA}$ )

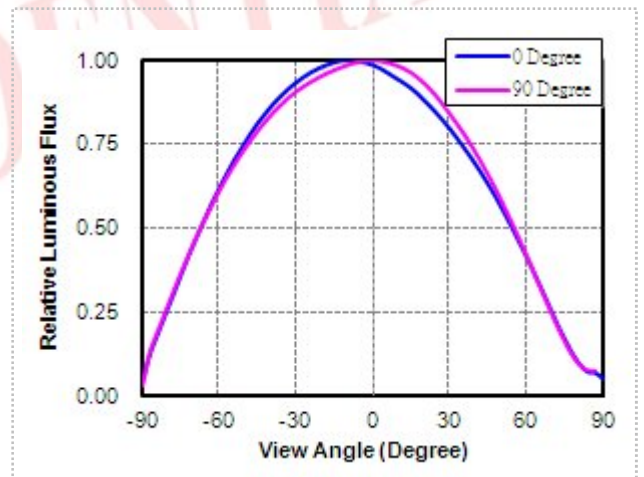



## Typical Electro-Optical-Thermal Characteristics Curves

5. Relative Luminous Flux vs. Ambient Temperature  
( $I_F=20\text{mA}$ )

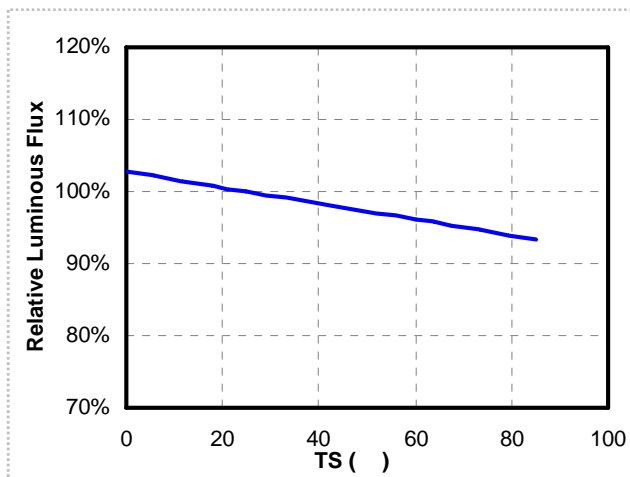

6. Forward Voltage vs. Ambient Temperature  
( $I_F=20\text{mA}$ )

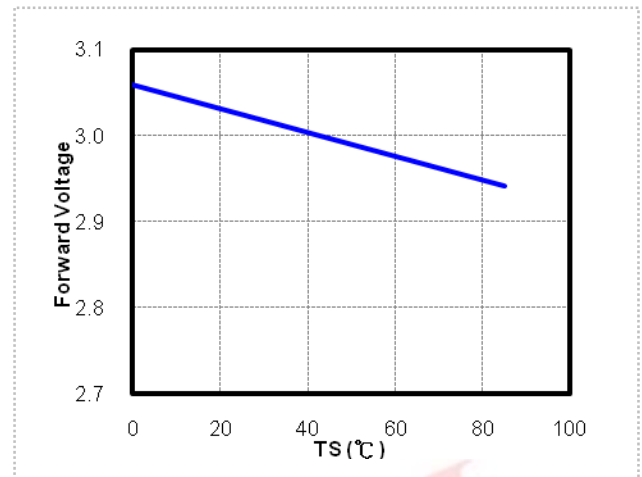

7. Chromaticity Coordinates vs. Ambient Temperature  
( $I_F=20\text{mA}$ )

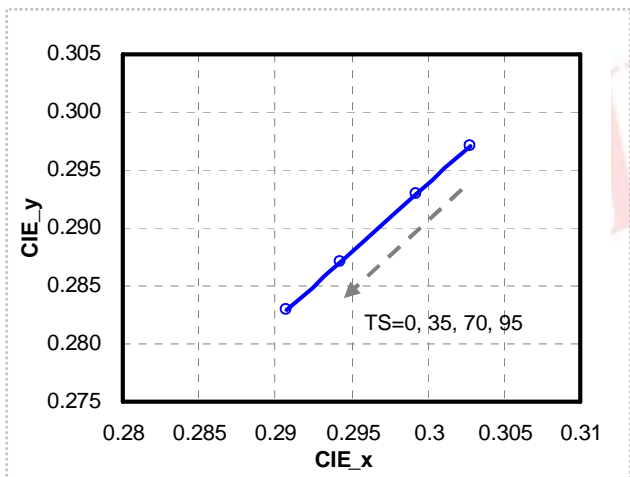

8. Forward Current De-rating Curve

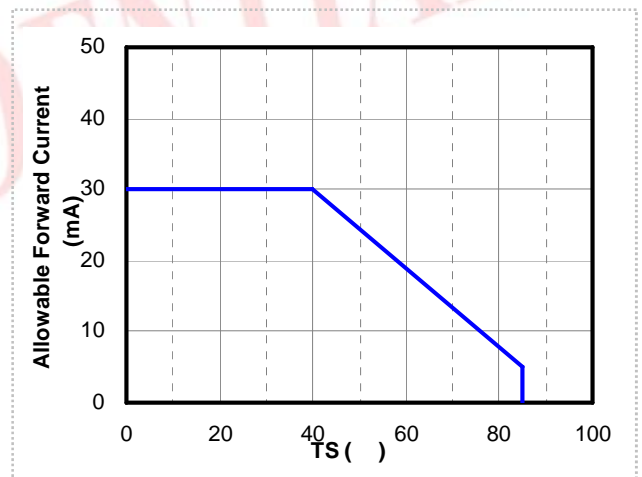

### Label Explanation

CAT: Luminous Flux Rank

HUE: Chromaticity Coordinates

REF: Forward Voltage Rank



### Reel Dimensions

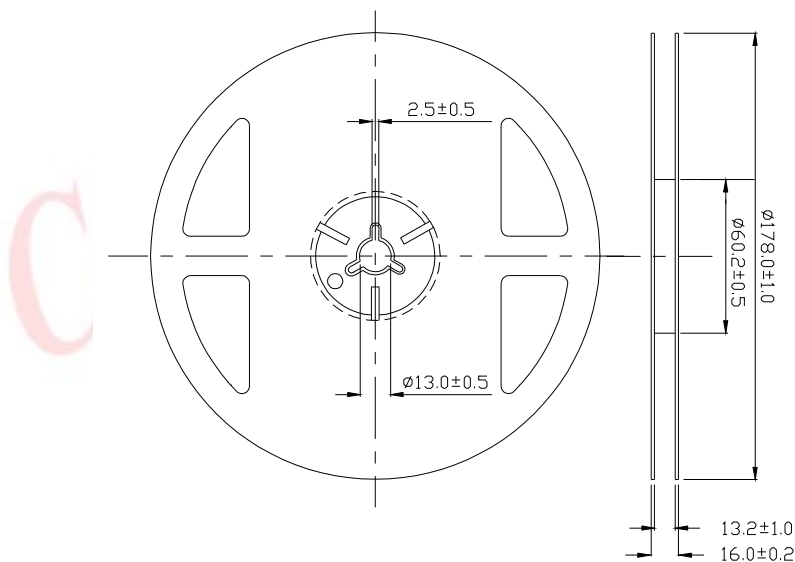

### Note:

The tolerances unless mentioned is  $\pm 0.1$  mm, Unit = mm.

**Carrier Tape Dimensions: Loaded Quantity 250 up/500/1000/2000 pcs. Per Reel**

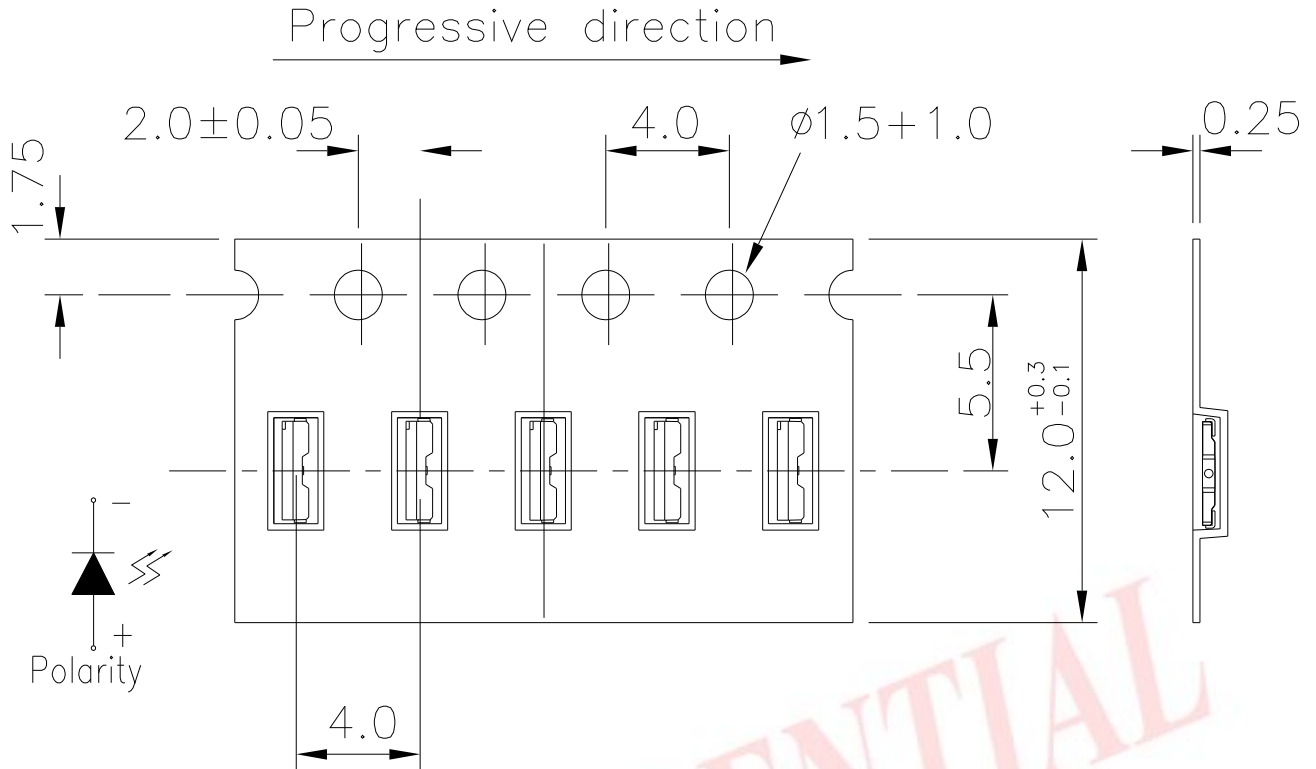

**Note:** The tolerances unless mentioned is  $\pm 0.1$  mm, Unit = mm.

**Moisture Resistant Packaging**

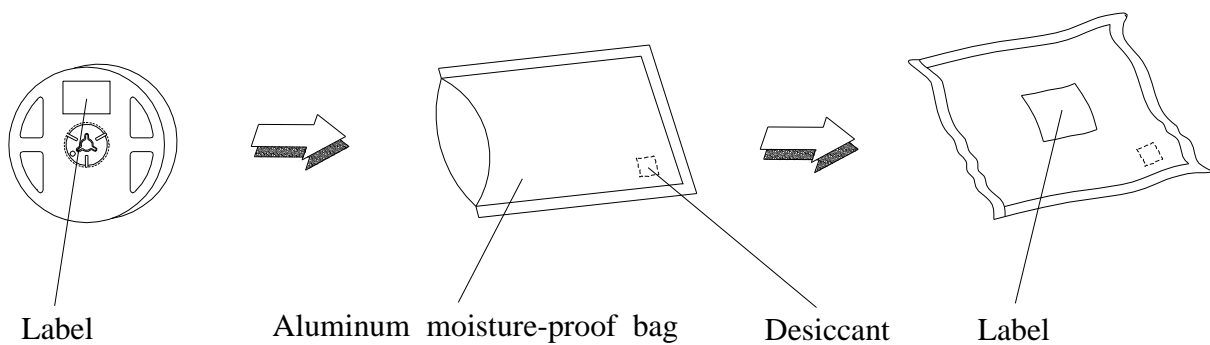

## Reliability Test Items and Conditions

The reliability of products shall be satisfied with items listed below.

Confidence level : 90%

LTPD : 10%

NO	Item	Test Condition		Test Hours / Times	Criteria	
		Temp./ Humidity	I <sub>F</sub> (mA)		I <sub>v</sub> @ 20mA	V <sub>F</sub> @ 20mA
1	Reflow Soldering	T <sub>Sld</sub> = 260 , Max. 10sec.		2 times	<±5%	<±5%
2	Temperature Cycle	-40 ~ 100 30min. (5min.) 30min.		200 cycles	I <sub>v</sub> > 70%, V <sub>F</sub> < 110%,	
3	Thermal Shock	-10 ~ 100 20min. (<15sec.) 20min.		200 cycles		
4	Low Temp. Storage	T <sub>a</sub> = -40	--	1000 hrs		
5	High Temp. Storage	T <sub>a</sub> = 100	--	1000 hrs		
6	Temp. Humidity Storage	T <sub>a</sub> = 60 / 90%RH	--	1000 hrs		
7	Steady State Operating Life of Low Temp.	T <sub>a</sub> = -40	20	1000 hrs		
8	Steady State Operating Life Condition 1	T <sub>a</sub> = 25 / Room Humidity	20	1000 hrs		
9	Steady State Operating Life Condition 2	T <sub>a</sub> = 60	20	1000 hrs		
10	Steady State Operating Life of High Temp.	T <sub>a</sub> = 85	5	1000 hrs		
11	Steady State Operating Life of High Humidity Heat	T <sub>a</sub> = 60 / 90%RH	20	1000 hrs		

Notes:

1. Sampling for each test item: 22 (pcs.)
2. Test board: PCB board thickness=1.0mm, copper layer thickness=0.07mm, R<sub>th j-a</sub> 380 /W.
3. Measurements are performed after allowing the LEDs to return to room temperature.

## Precautions for Use

### 1. Over-current-proof

Customer must apply resistors for protection, otherwise slight voltage shift will cause big current change ( Burn out will happen ).

### 2. Soldering Condition

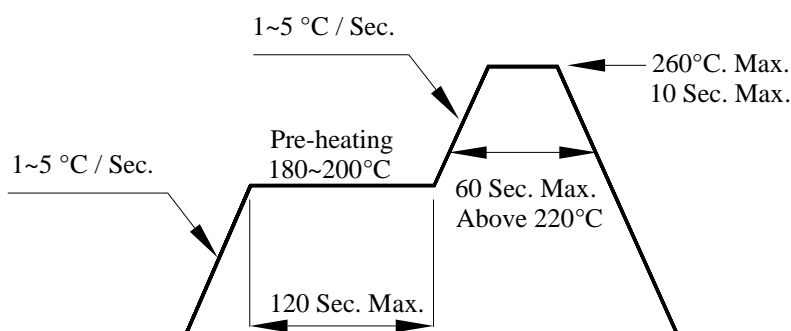

#### 2.1 Pb-free solder temperature profile

2.2 Reflow soldering should not be done more than two times.

2.3 When soldering, do not put stress on the LEDs during heating.

2.4 After soldering, do not warp the circuit board.

### 3. Soldering Iron

Each terminal is to go to the tip of soldering iron temperature less than 350 for 3 seconds within once in less than the soldering iron capacity 25W. Leave two seconds and more intervals,

and do soldering of each terminal. Be careful because the damage of the product is often started at the time of the hand solder.

### 4. Repairing

Repair should not be done after the LEDs have been soldered. When repairing is unavoidable, a double-head soldering iron should be used (as below figure). It should be confirmed beforehand whether the characteristics of the LEDs will or will not be damaged by repairing.

## 5. Storage

- 5.1 Do not open moisture proof bag before the products are ready to use.
- 5.2 Before opening the package: The LEDs should be used within one year and kept at 30 °C or less and 70%RH or less.
- 5.3 After opening the package: We recommend that the LED should be soldered quickly (within 3 days). The soldering condition is 30 °C or less and 60%RH or less. If unused LEDs remain, it should be stored in moisture proof.
- 5.4 If the moisture absorbent material (silica gel) has faded away or the LEDs have exceeded the storage time, baking treatment should be performed using the following conditions.  
Baking treatment: 60±5 °C for 24 hours. (One time only)

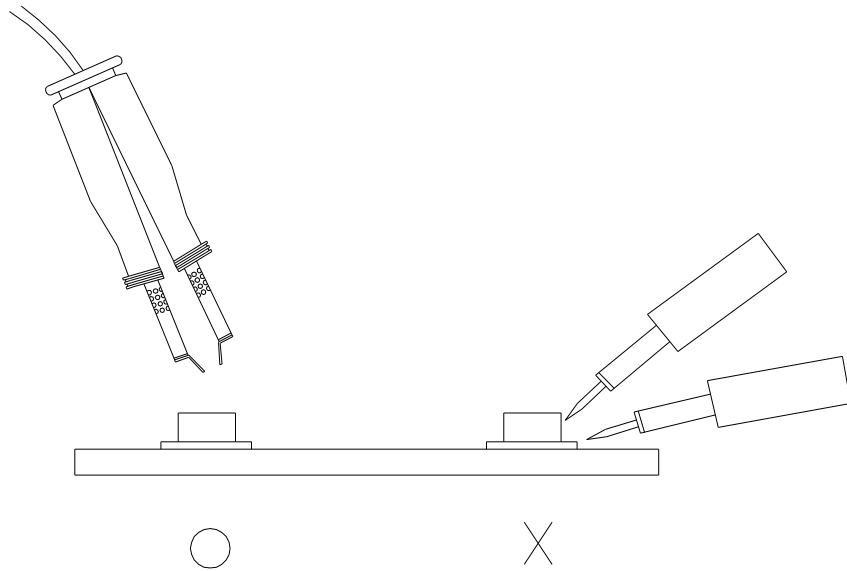

## 6. Handling Indications

During processing, mechanical stress on the surface should be minimized as much as possible.

Sharp objects of all types should not be used to pierce the sealing compound.

# Mouser Electronics

Authorized Distributor

Click to View Pricing, Inventory, Delivery & Lifecycle Information:

[Everlight:](#)

[EAPL3809WA1](#)