

EAFL2016W21A0

Received	
<input checked="" type="checkbox"/>	MASS PRODUCTION
<input type="checkbox"/>	PRELIMINARY
<input type="checkbox"/>	CUSTOMER DESIGN
DEVICE NO. : DHE-0002847	
PAGE : 12	

Revised record		
REV.	DESCRIPTION	RELEASE DATE
1	New spec	Mar.10.2015
2	Change M.P.	Nov.15.2016

EAFL2016W21A0

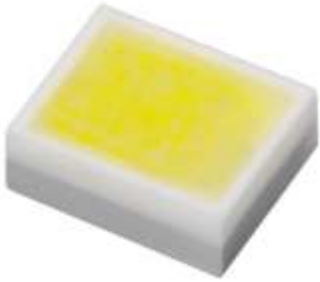

Features

- Feature of the device : small package with high efficiency
- Typical luminous flux@ 1A : 230 lm
- Optical efficiency@1A : 67.64 lm/W
- ESD protection (according to JEDEC 3b) (HBM air or contact discharge)up to 8KV
- Binning Parameters : Brightness, Forward Voltage and Chromaticity
- Grouping parameter: total luminous flux, color coordinates.
- RoHS compliant & Pb free.

Applications

- Mobile Phone Camera Flash(Camera flash light /strobe light for mobile devices)
- Torch light for DV(Digital Video) application
- Indoor lighting applications
- Signal and symbol luminaries for orientation maker lights (e.g. steps, exit ways, etc.)
- TFT backlighting
- Exterior and interior illumination applications
- Decorative and Entertainment Lighting
- Exterior and interior automotive illumination

Device Selection Guide

Chip Materials	Emitted Color
InGaN	Cool White

Absolute Maximum Ratings

Parameter	Symbol	Rating	Unit
DC Forward Current (Torch Mode)	I_F	350	mA
Peak Pulse Current (400 ms on / 3600 ms off / 30000 cycle)	I_{Pulse}	1500	mA
ESD Resistance (JEDEC 3b)	V_B	8000	V
Reverse Voltage	V_R	Note 1	V
Junction Temperature	T_J	150	°C
Operating Temperature	T_{Opr}	-40 ~ +85	°C
Storage Temperature	T_{Stg}	-40 ~ +100	°C
Soldering Temperature	T_{Sol}	260	°C
Allowable Reflow Cycles	n/a	2	Cycles
Substrate Temperature	T_s	70(IF=1000mA)	°C
Viewing Angle ₍₂₎	$2\theta_{1/2}$	120	Deg
Power Dissipation (Pulse Mode)	P_d	5.925	W

Notes:

1. The CHIN series LEDs are not designed for reverse bias used.
2. View angle measurement tolerance $\pm 5^\circ$
3. Avoid operating CHIN series LEDs at maximum operating temperature exceed 1 hour.
4. All specification are assured by reliability test for 1000hr, IV degradation less than 30%.
5. All reliability items are tested under good thermal management with 1.0x 1.0 cm² MCPCB.
6. Peak pulse current shall be applied under conditions as max duration time 400ms and max duty cycle 10%
7. Operate LED component at maximum rating conditions continuously will cause possible permanent damage and de-rating parameters. Exercise multiple maximum rating parameters simultaneously should not be allowed. When maximum rating parameters are applied over a long period will result potential reliability issue.

JEDEC Moisture Sensitivity

Level	Floor Life		Soak Requirements Standard	
	Time (hours)	Conditions	Time (hours)	Conditions
1	Unlimited	≤ 30°C / 85% RH	168 (+5/-0)	85°C / 85% RH

Electro-Optical Characteristics (Ts=25°C)

Parameter	Symbol	Min.	Typ.	Max.	Unit	Condition
Luminous Flux ₍₁₎	I _v	200	230	----	lm	I _F =1000mA
Forward Voltage ₍₂₎₍₃₎	V _F	2.85	----	3.95	V	
Color Temperature	CCT	5500	6000	6500	K	

Forward Voltage Binning

Bin	Symbol	Min.	Typ.	Max.	Unit	Condition
2832	V _F	2.85	----	3.25	V	I _F =1000mA
3235	V _F	3.25	----	3.55		
3539	V _F	3.55	----	3.95		

Luminous Flux Binning

Bin	Symbol	Min.	Typ.	Max.	Unit	Condition
J6	I _v	200	----	250	lm	I _F =1000mA
J7	I _v	250	----	300		

Notes:

1. Luminous Flux, illuminance measurement tolerance : ±10%
2. Forward voltage measurement tolerance : ±0.1V
3. Electric and optical data is tested at 50 ms pulse condition.
4. Low current voltage measurement tolerance: ±10%
5. Temperature of solder pad : 25°C

Cool White Bin Structure

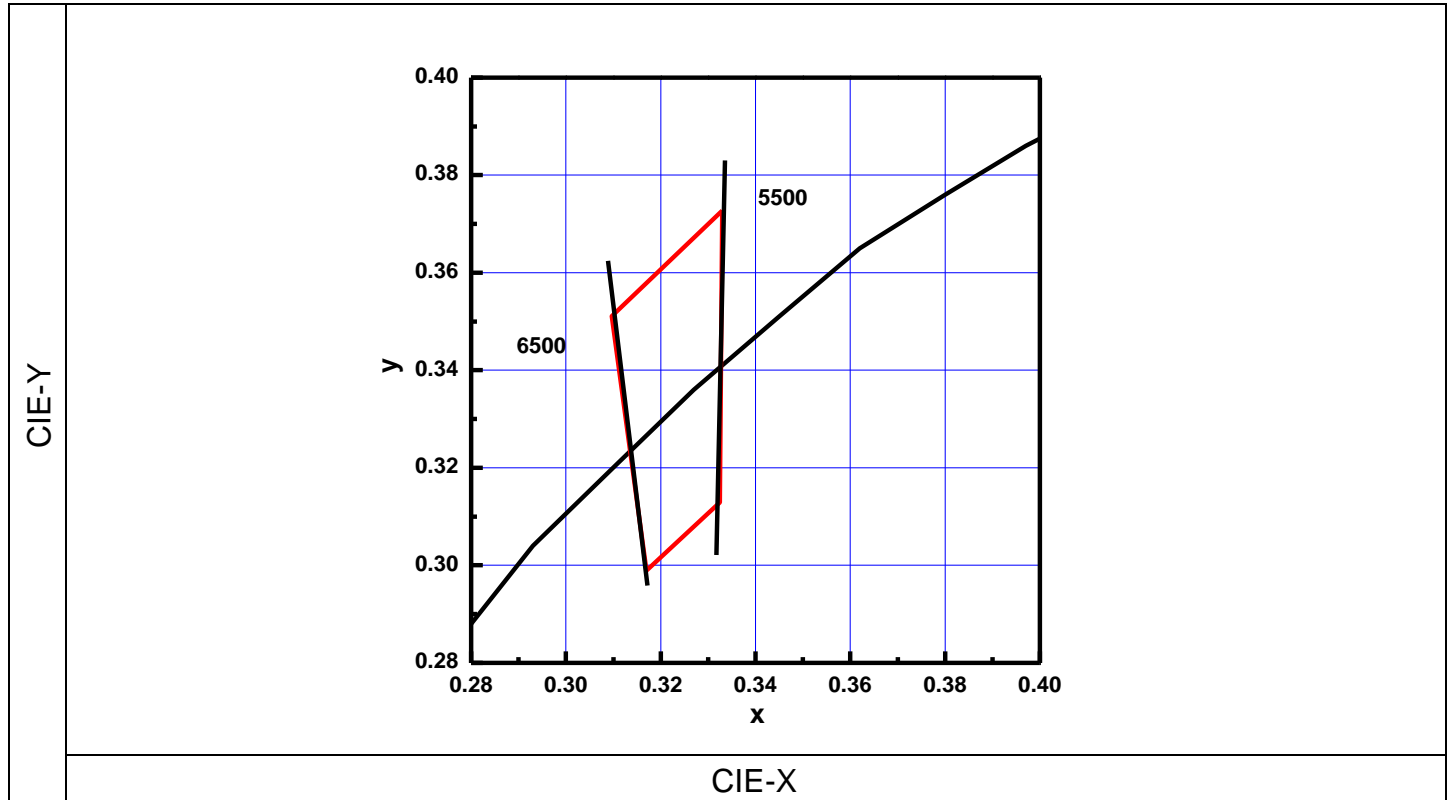

Bin	CIE-X	CIE-Y	Reference Range
5565	0.3330	0.3727	5500K ~ 6500K
	0.3097	0.3511	
	0.3170	0.2989	
	0.3325	0.3129	

Notes:

1. Color coordinates measurement allowance : ± 0.01
2. Color bins are defined at IF=1000mA operation.

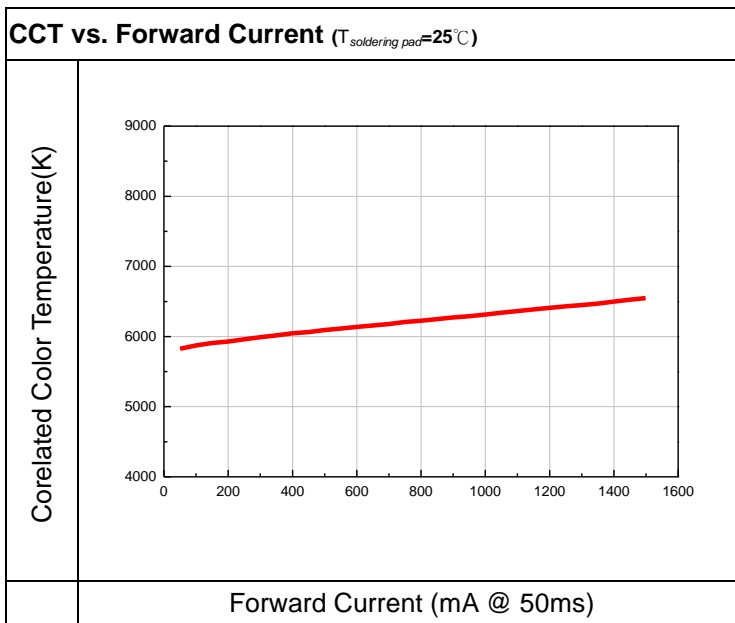
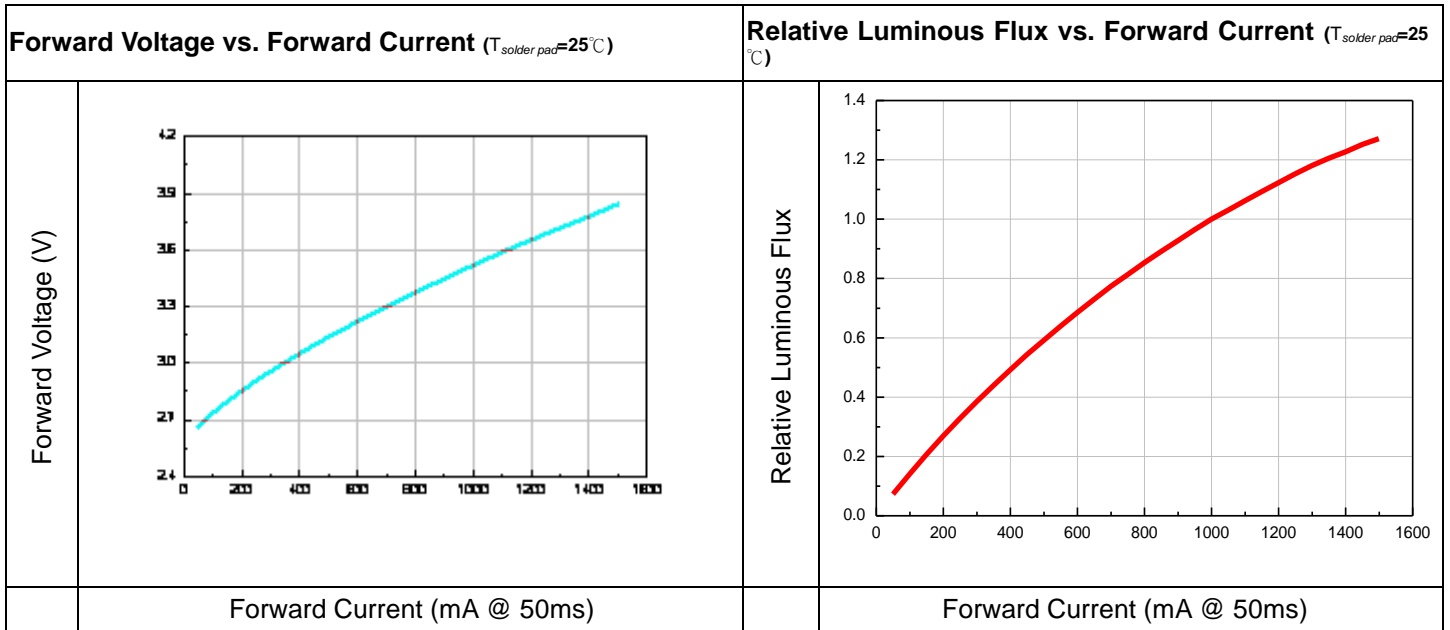

Notes:

1. All correlation data is tested under superior thermal management with 1 x 1 cm² MCPCB.

Package Dimension

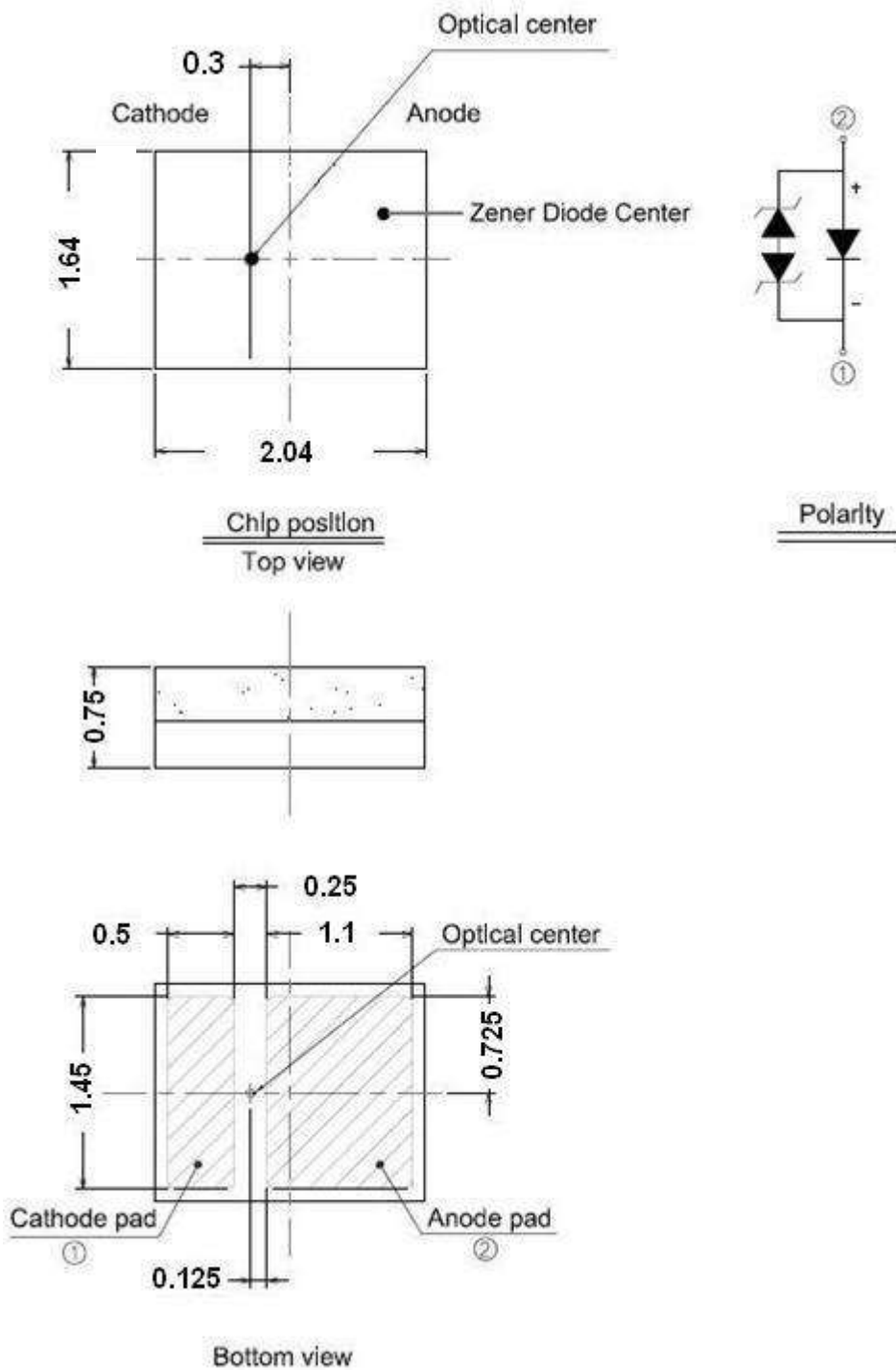

Notes:

1. Dimensions are in millimeters.
2. Tolerances unless mentioned are ± 0.1 mm.

Moisture Resistant Packing Materials

Product Labeling



- CPN : Customer's Product Number
- P/N : Everlight Americas Production Number
- QTY : Packing Quantity
- CAT : Luminous Flux (Brightness) Bin
- HUE : Color Bin
- REF : Forward Voltage Bin
- LOT No : Lot Number

Carrier Tape Dimensions: Loaded Quantity 2000 pcs Per Reel

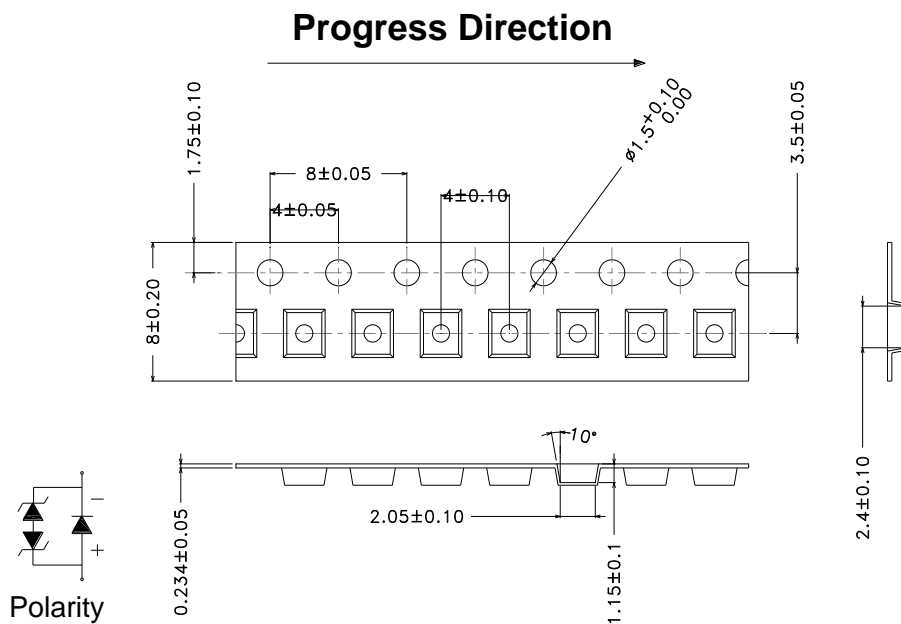

Notes:

1. Dimensions are in millimeters.
2. Tolerances for fixed dimensions are ± 0.1 mm.

Emitter Reel Dimensions

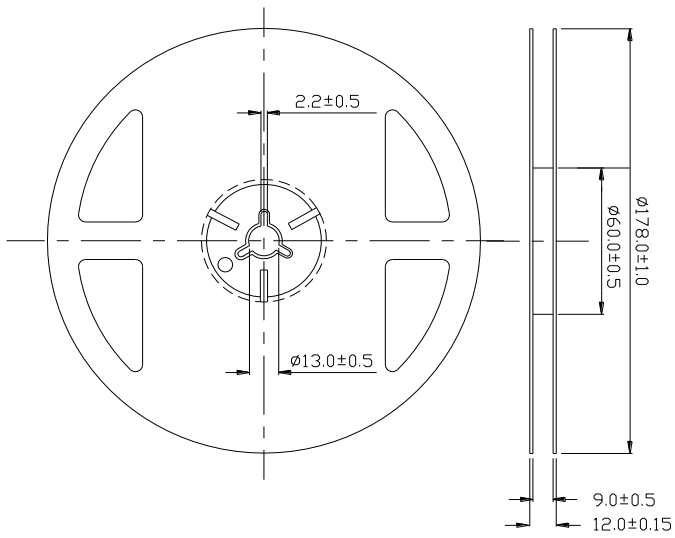

Notes:

1. Dimensions are in millimeters.

Moisture Resistant Packing Process

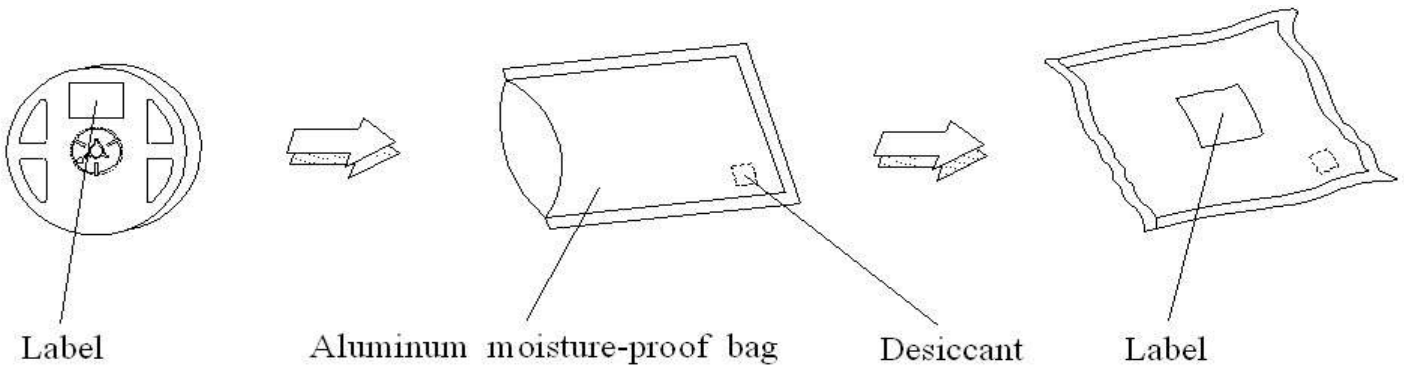

Reflow Soldering Characteristics

Soldering and Handling

1. Over-current-proof

Though CHIN series has conducted ESD protection mechanism, customers must not use the device in reverse and should apply resistors for extra protection. Otherwise, slight voltage shift may cause enormous current shift and burn out failure would happen.

2. Storage

- 2.1 Do not open the moisture proof bag before the products are ready to use.
- 2.2 Before opening the package, the LEDs should be stored at temperature less than 30°C and relative humidity less than 90%.
- 2.3 After opening the package, the LEDs should be stored at temperature less than 30°C and relative humidity less than 85%.
- 2.4 If the moisture absorbent material (silicone gel) has faded away or the LEDs have exceeded the storage time, baking treatment should be implemented based on the following conditions: Pre-curing at 60±5°C for 24 hours.

3. Thermal Management

- 3.1 For maintaining the high flux output and achieving reliability, CHIN series LEDs should be mounted on a metal core printed circuit board (MCPCB), with proper thermal connection to dissipate approximately 1W to 5W of thermal energy under normal operation.
- 3.2 Sufficient thermal management must be conducted, or the die junction temperature will be over the limit under large electronic driving and LEDs lifetime will decrease critically.
- 3.3 When operating, the solder pad temperature (or the board temperature nearby the LED) must controlled under 70°C.

4. Soldering Condition

4.1 Soldering Pad

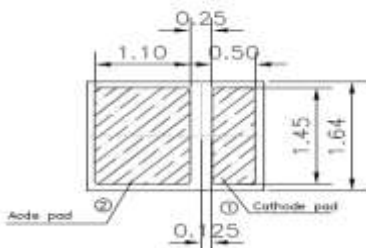

Component bottom view

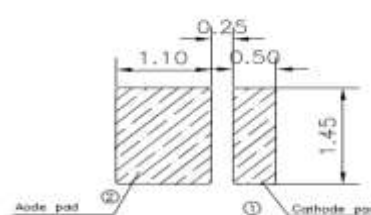

Recommended soldering pattern layout

4.2 For Reflow Process

4.2.1 Lead reflow soldering temperature profile

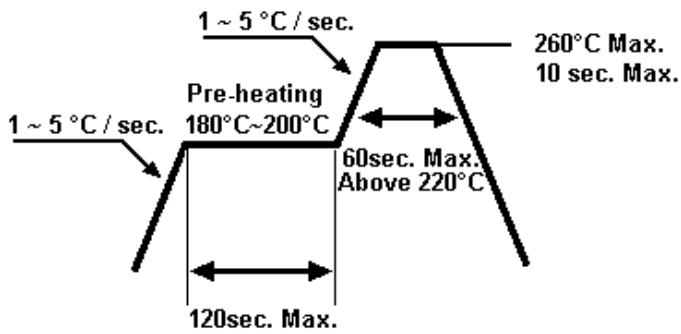

4.2.2 Reflow soldering should not be done more than two times.

4.2.3 While soldering, do not put stress on the LEDs during heating.

4.2.4 After soldering, do not warp the circuit board.