

**GenX3™**  
**600V IGBT**

High-Speed PT IGBTs for  
40-100kHz Switching

**IXGI48N60C3\***  
**IXGA48N60C3**  
**IXGP48N60C3**  
**IXGH48N60C3**  
**\*Obsolete Part Number**

**V<sub>CES</sub> = 600V**  
**I<sub>C110</sub> = 48A**  
**V<sub>CE(sat)</sub> ≤ 2.5V**  
**t<sub>fi(typ)</sub> = 38ns**

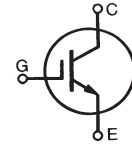

Symbol	Test Conditions	Maximum Ratings	
V <sub>CES</sub>	T <sub>C</sub> = 25°C to 150°C	600	V
V <sub>CGR</sub>	T <sub>J</sub> = 25°C to 150°C, R <sub>GE</sub> = 1MΩ	600	V
V <sub>GES</sub>	Continuous	± 20	V
V <sub>GEM</sub>	Transient	± 30	V
I <sub>C25</sub>	T <sub>C</sub> = 25°C	75	A
I <sub>C110</sub>	T <sub>C</sub> = 110°C	48	A
I <sub>CM</sub>	T <sub>C</sub> = 25°C, 1ms	250	A
I <sub>A</sub>	T <sub>C</sub> = 25°C	30	A
E <sub>AS</sub>	T <sub>C</sub> = 25°C	300	mJ
<b>SSOA</b> <b>(RBSOA)</b>	V <sub>GE</sub> = 15V, T <sub>VJ</sub> = 125°C, R <sub>G</sub> = 3Ω Clamped Inductive Load	I <sub>CM</sub> = 100 V <sub>CE</sub> ≤ V <sub>CES</sub>	A
P <sub>C</sub>	T <sub>C</sub> = 25°C	300	W
T <sub>J</sub>		-55 ... +150	°C
T <sub>JM</sub>		150	°C
T <sub>stg</sub>		-55 ... +150	°C
T <sub>L</sub>	Maximum Lead Temperature for Soldering	300	°C
T <sub>SOLD</sub>	1.6 mm (0.062in.) from Case for 10s	260	°C
F <sub>C</sub>	Mounting Force (TO-263)	10..65 / 2.5..14.6	N/lb.
M <sub>d</sub>	Mounting Torque (TO-247&TO-220)	1.13/10	Nm/lb.in.
<b>Weight</b>	TO-262 Lead	0.4	g
	TO-263	2.5	g
	TO-220	3.0	g
	TO-247	6.0	g

**Features**

- Optimized for Low Switching Losses
- Square RBSOA
- Avalanche Rated
- Fast Switching
- International Standard Packages

**Advantages**

- High Power Density
- Low Gate Drive Requirement

**Applications**

- High Frequency Power Inverters
- UPS
- Motor Drives
- SMPS
- PFC Circuits
- Battery Chargers
- Welding Machines
- Lamp Ballasts

Symbol	Test Conditions (T <sub>J</sub> = 25°C Unless Otherwise Specified)	Characteristic Values		
		Min.	Typ.	Max.
BV <sub>CES</sub>	I <sub>C</sub> = 250μA, V <sub>GE</sub> = 0V	600		V
V <sub>GE(th)</sub>	I <sub>C</sub> = 250μA, V <sub>CE</sub> = V <sub>GE</sub>	3.0		5.5 V
I <sub>CES</sub>	V <sub>CE</sub> = V <sub>CES</sub> , V <sub>GE</sub> = 0V T <sub>J</sub> = 125°C			25 μA 250 μA
I <sub>GES</sub>	V <sub>CE</sub> = 0V, V <sub>GE</sub> = ± 20V			±100 nA
V <sub>CE(sat)</sub>	I <sub>C</sub> = 30A, V <sub>GE</sub> = 15V, Note 1 T <sub>J</sub> = 125°C		2.3 1.8	2.5 V V

Symbol ( $T_J = 25^\circ\text{C}$ Unless Otherwise Specified)	Test Conditions	Characteristic Values		
		Min.	Typ.	Max.
$g_{fs}$	$I_C = 30\text{A}, V_{CE} = 10\text{V}$ , Note 1	20	30	S
$C_{ies}$	$V_{CE} = 25\text{V}, V_{GE} = 0\text{V}, f = 1\text{MHz}$		1960	pF
$C_{oes}$			207	pF
$C_{res}$			66	pF
$Q_g$	$I_C = 30\text{A}, V_{GE} = 15\text{V}, V_{CE} = 0.5 \cdot V_{CES}$		77	nC
$Q_{ge}$			16	nC
$Q_{gc}$			32	nC
$t_{d(on)}$	<b>Inductive Load, <math>T_J = 25^\circ\text{C}</math></b> $I_C = 30\text{A}, V_{GE} = 15\text{V}$ $V_{CE} = 400\text{V}, R_G = 3\Omega$ Note 2		19	ns
$t_{ri}$			26	ns
$E_{on}$			0.41	mJ
$t_{d(off)}$			60	100 ns
$t_{fi}$			38	ns
$E_{off}$			0.23	0.42 mJ
$t_{d(on)}$	<b>Inductive Load, <math>T_J = 125^\circ\text{C}</math></b> $I_C = 30\text{A}, V_{GE} = 15\text{V}$ $V_{CE} = 400\text{V}, R_G = 3\Omega$ Note 2		19	ns
$t_{ri}$			26	ns
$E_{on}$			0.65	mJ
$t_{d(off)}$			92	ns
$t_{fi}$			95	ns
$E_{off}$			0.57	mJ
$R_{thJC}$			0.42	$^\circ\text{C/W}$
$R_{thCS}$	(TO-247)		0.21	$^\circ\text{C/W}$
	(TO-220)		0.50	$^\circ\text{C/W}$

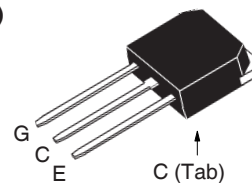
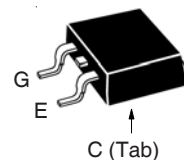
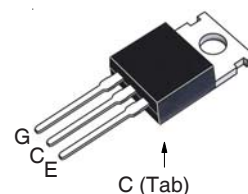
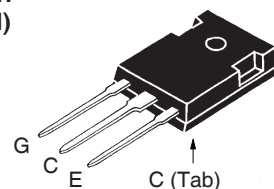
**TO-262 Lead (IXGI)**

**TO-263 (IXGA)**

**TO-220 (IXGP)**

**TO-247 (IXGH)**

G = Gate      C = Collector  
E = Emitter    Tab = Collector

**Notes:**

1. Pulse test,  $t \leq 300\mu\text{s}$ , duty cycle,  $d \leq 2\%$ .
2. Switching times & energy losses may increase for higher  $V_{CE}(\text{Clamp})$ ,  $T_J$  or  $R_G$ .

**IXYS Reserves the Right to Change Limits, Test Conditions and Dimensions.**

IXYS MOSFETs and IGBTs are covered by one or more of the following U.S. patents:

4,835,592	4,931,844	5,049,961	5,237,481	6,162,665	6,404,065 B1	6,683,344	6,727,585	7,005,734 B2	7,157,338B2
4,860,072	5,017,508	5,063,307	5,381,025	6,259,123 B1	6,534,343	6,710,405 B2	6,759,692	7,063,975 B2	
4,881,106	5,034,796	5,187,117	5,486,715	6,306,728 B1	6,583,505	6,710,463	6,771,478 B2	7,071,537	

**Fig. 1. Output Characteristics @  $T_J = 25^\circ\text{C}$**

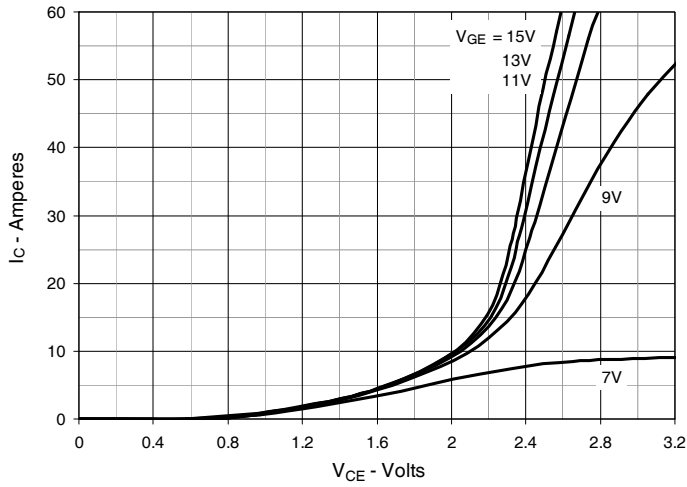

**Fig. 2. Extended Output Characteristics @  $T_J = 25^\circ\text{C}$**

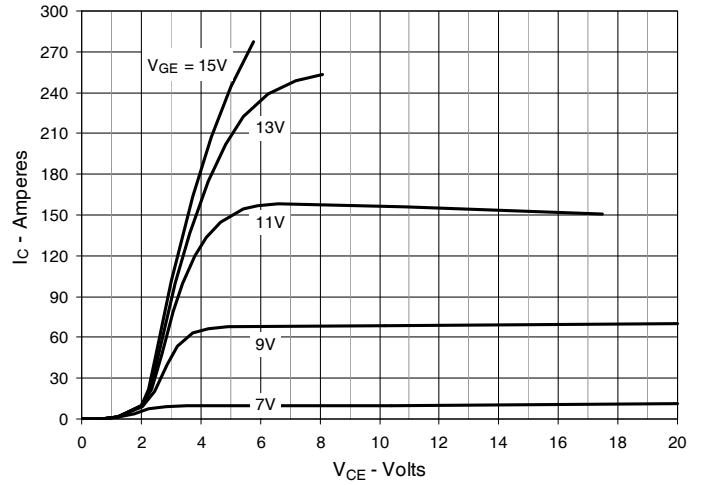

**Fig. 3. Output Characteristics @  $T_J = 125^\circ\text{C}$**

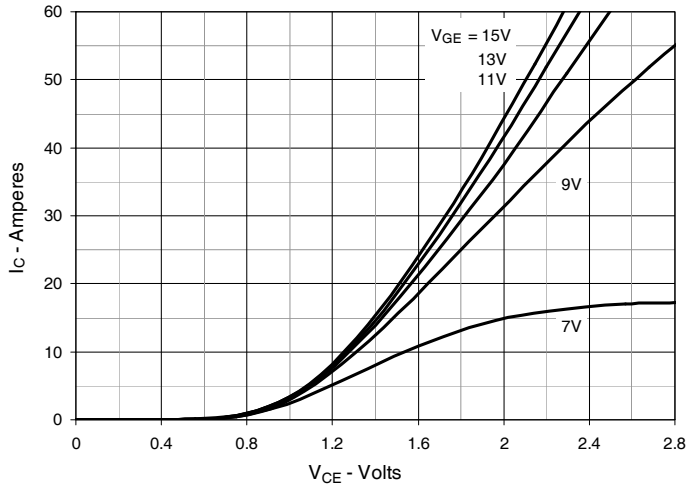

**Fig. 4. Dependence of  $V_{CE(sat)}$  on Junction Temperature**

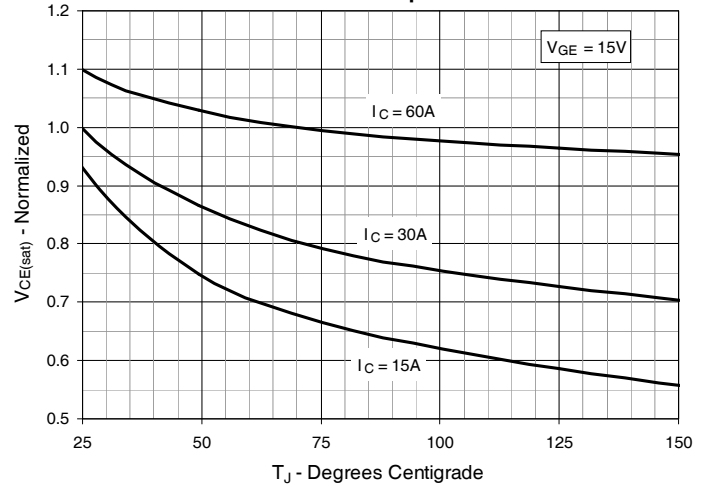

**Fig. 5. Collector-to-Emitter Voltage vs. Gate-to-Emitter Voltage**

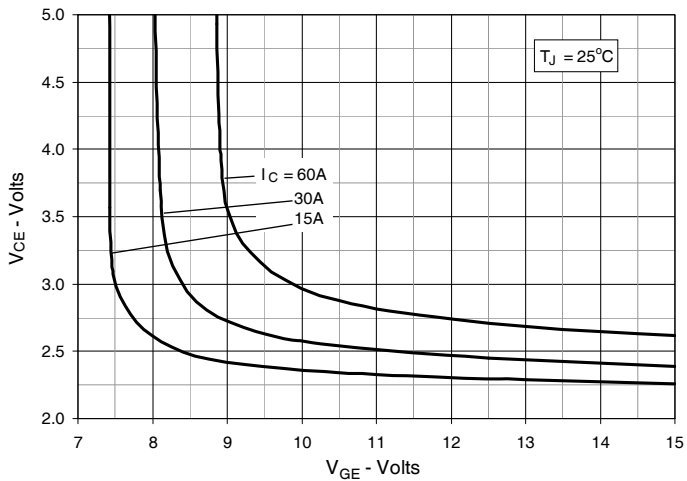

**Fig. 6. Input Admittance**

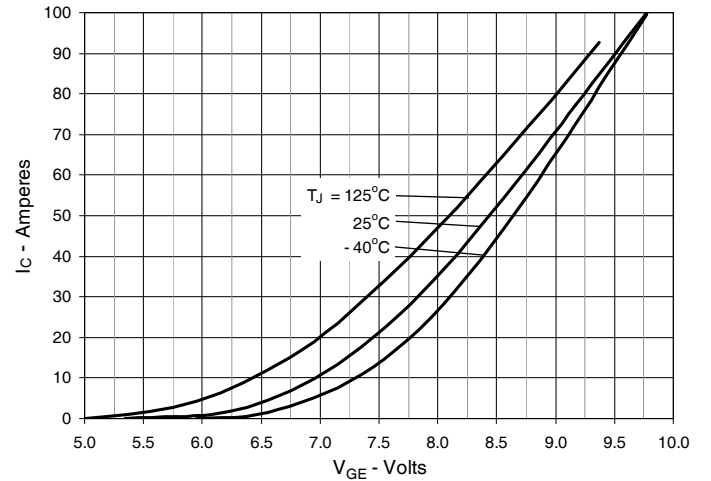

Fig. 7. Transconductance

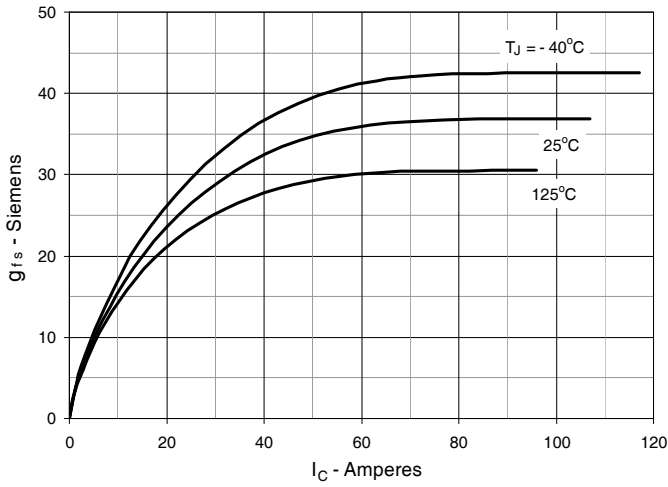

Fig. 8. Gate Charge

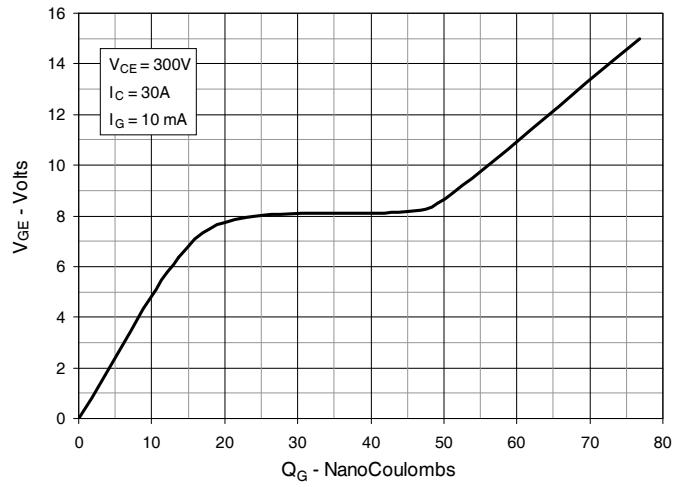

Fig. 9. Capacitance

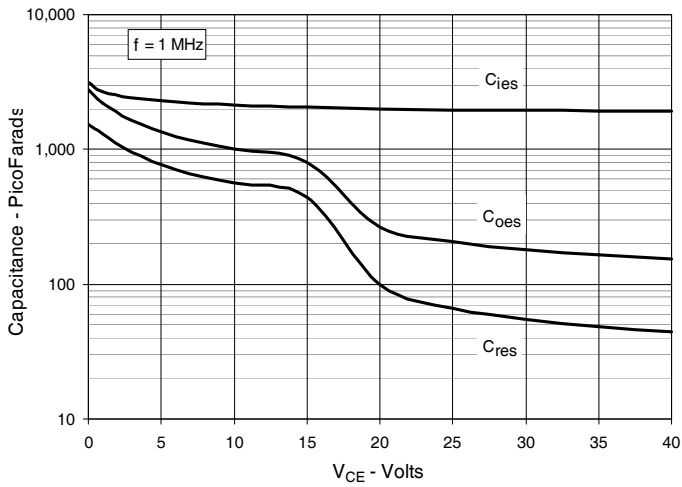

Fig. 10. Reverse-Bias Safe Operating Area

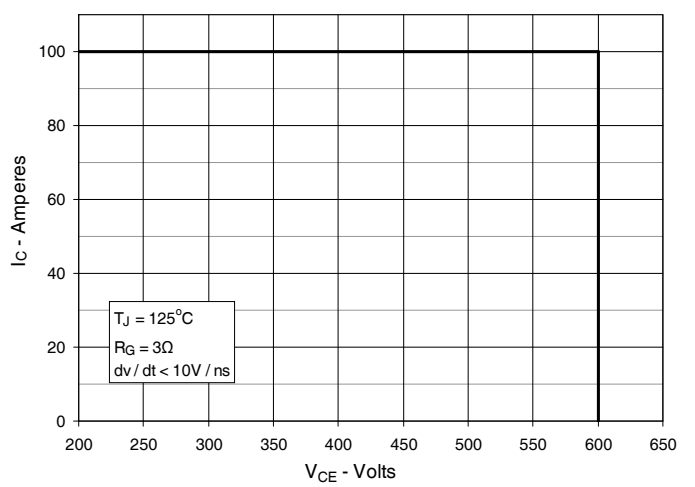
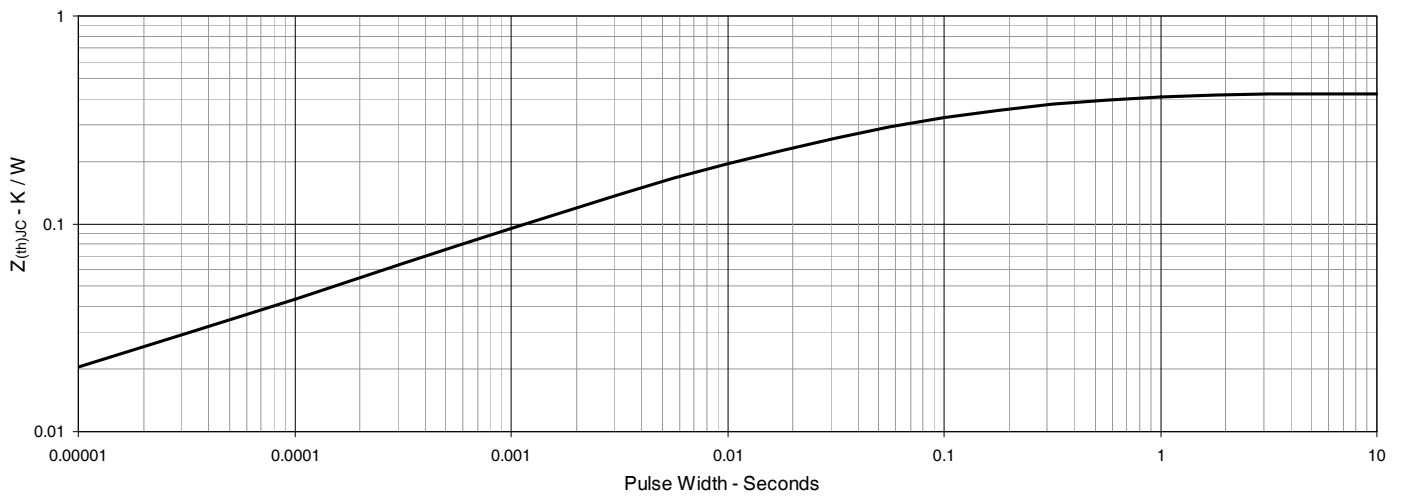
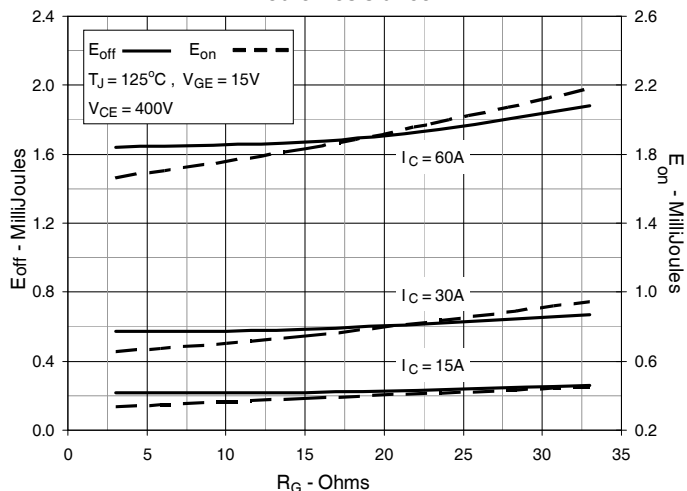

Fig. 11. Maximum Transient Thermal Impedance



**Fig. 12. Inductive Switching Energy Loss vs. Gate Resistance**



**Fig. 13. Inductive Switching Energy Loss vs. Collector Current**

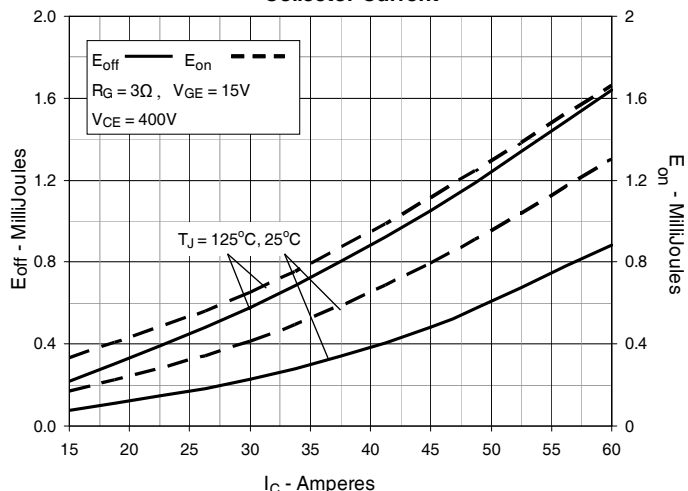

**Fig. 14. Inductive Switching Energy Loss vs. Junction Temperature**

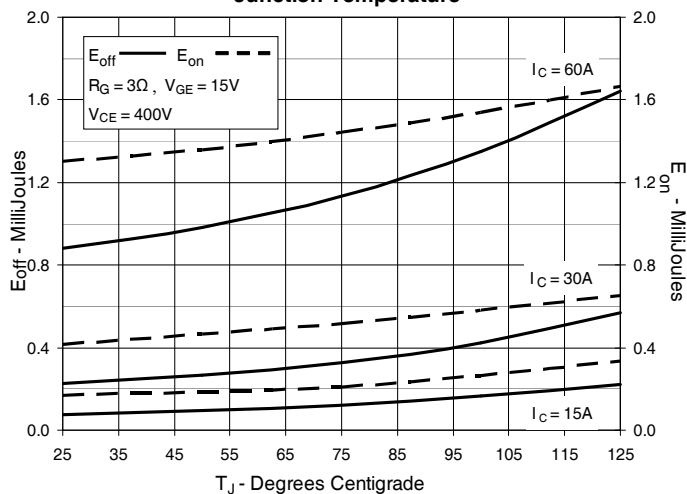

**Fig. 15. Inductive Turn-off Switching Times vs. Gate Resistance**

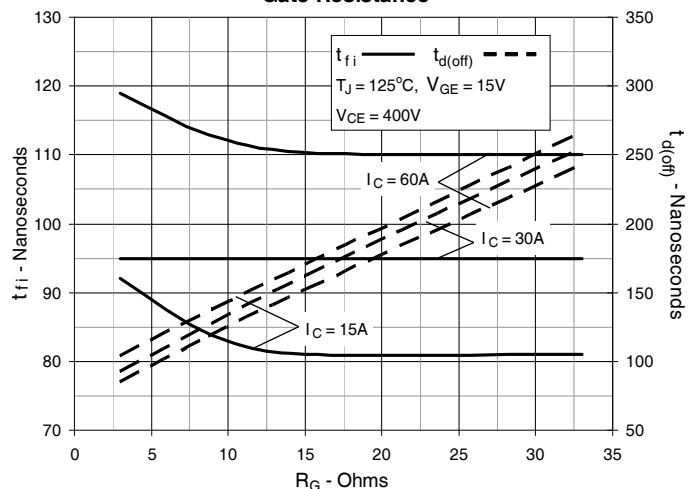

**Fig. 16. Inductive Turn-off Switching Times vs. Collector Current**

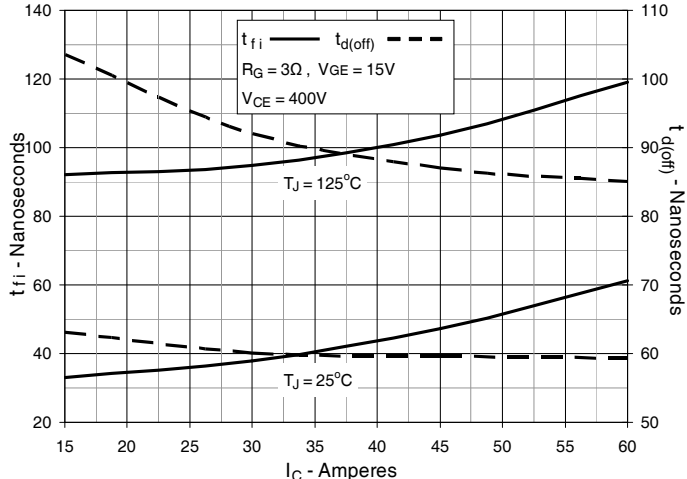

**Fig. 17. Inductive Turn-off Switching Times vs. Junction Temperature**

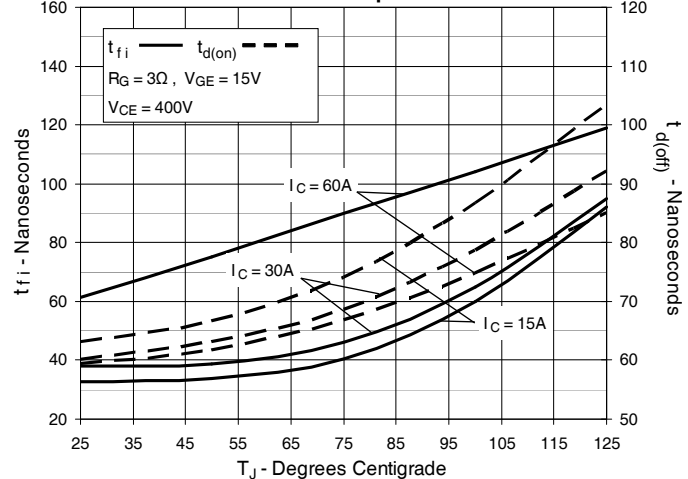

**Fig. 18. Inductive Turn-on Switching Times vs. Gate Resistance**

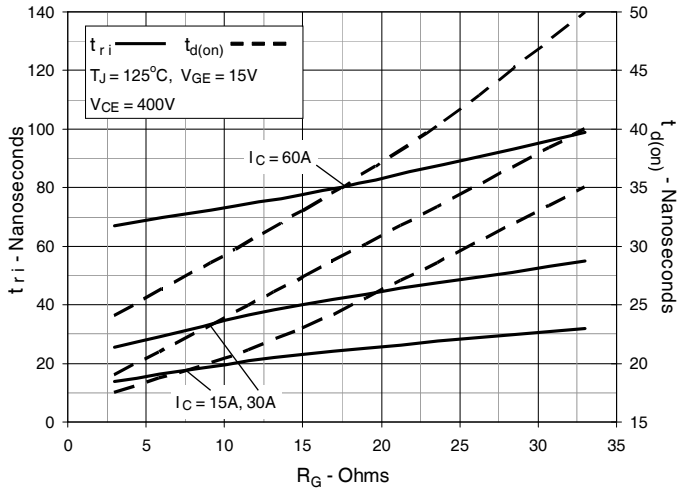

**Fig. 19. Inductive Turn-on Switching Times vs. Collector Current**

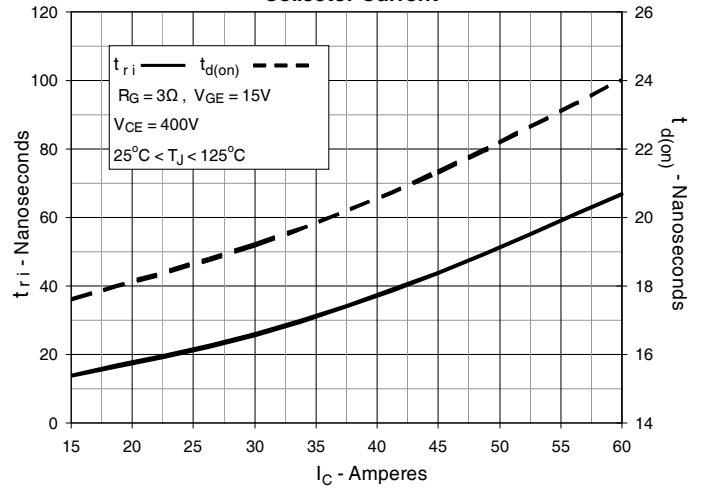

**Fig. 20. Inductive Turn-on Switching Times vs. Junction Temperature**

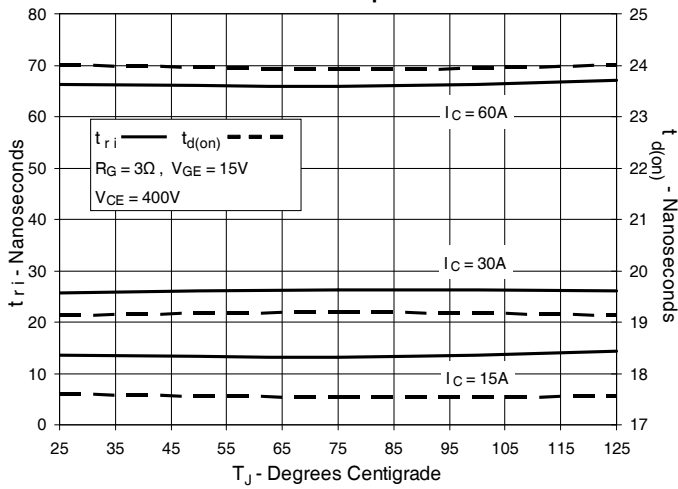

### TO - 262 Leaded Outline

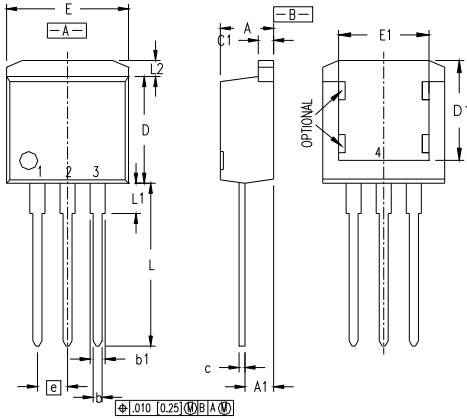

Pins: 1 - Gate 2,4 - Collector  
3 - Emitter

SYM	INCHES		MILLIMETERS	
	MIN	MAX	MIN	MAX
A	.160	.190	4.06	4.83
A1	.080	.110	2.03	2.79
b	.025	.039	0.51	0.99
b2	.025	.039	1.14	1.40
c	.018	.029	0.46	0.74
c2	.018	.029	1.14	1.40
D	.340	.380	8.64	9.65
D1	.315	.350	8.00	8.89
E	.380	.405	9.65	10.29
E1	.245	.320	6.22	8.13
e	.100 BSC		2.54 BSC	
L	.500	.580	14.61	15.88
L1	.080	.130	2.29	2.79
L2	.040	.055	1.02	1.40

### TO-263 Outline

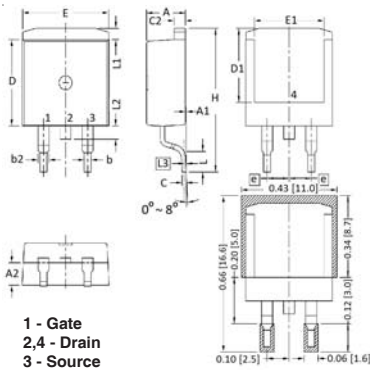

1 - Gate  
2,4 - Drain  
3 - Source

### TO-220 Outline

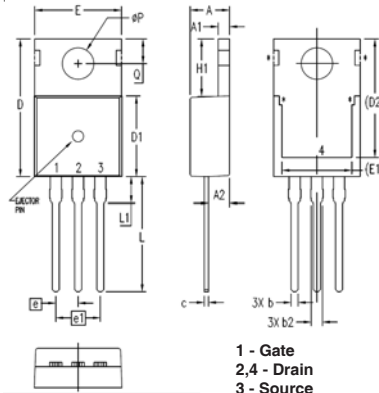

1 - Gate  
2,4 - Drain  
3 - Source

### TO-247 Outline

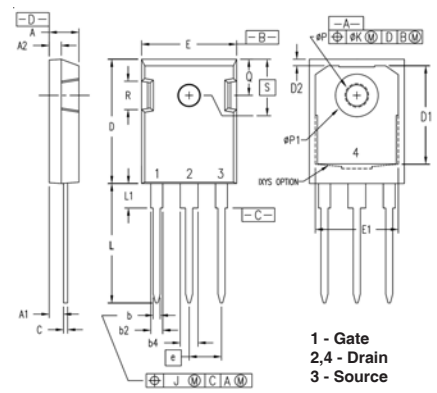

1 - Gate  
2,4 - Drain  
3 - Source

SYM	INCHES		MILLIMETER	
	MIN	MAX	MIN	MAX
A	.170	.185	4.30	4.70
A1	.000	.008	0.00	0.20
A2	.091	.098	2.30	2.50
b	.028	.035	0.70	0.90
b2	.046	.060	1.18	1.52
C	.018	.024	0.45	0.60
C2	.049	.060	1.25	1.52
D	.340	.370	8.63	9.40
D1	.300	.327	7.62	8.30
E	.380	.410	9.65	10.41
E1	.270	.330	6.86	8.38
e	.100 BSC		2.54 BSC	
H	.580	.620	14.73	15.75
L	.075	.105	1.91	2.67
L1	.039	.060	1.00	1.52
L2	—	.070	—	1.77
L3	.010 BSC		0.254 BSC	

SYM	INCHES		MILLIMETERS	
	MIN	MAX	MIN	MAX
A	.169	.185	4.30	4.70
A1	.047	.055	1.20	1.40
A2	.079	.106	2.00	2.70
b	.024	.039	0.60	1.00
b2	.045	.057	1.15	1.45
c	.014	.026	0.35	0.65
D	.587	.626	14.90	15.90
D1	.335	.370	8.50	9.40
(D2)	.500	.531	12.70	13.50
E	.382	.406	9.70	10.30
(E1)	.283	.323	7.20	8.20
e	.100 BSC		2.54 BSC	
e1	.200 BSC		5.08 BSC	
H1	.244	.268	6.20	6.80
L	.492	.547	12.50	13.90
L1	.110	.154	2.80	3.90
∅P	.134	.150	3.40	3.80
Q	.106	.126	2.70	3.20

SYM	INCHES		MILLIMETERS	
	MIN	MAX	MIN	MAX
A	.190	.205	4.83	5.21
A1	.090	.100	2.29	2.54
A2	.075	.085	1.91	2.16
b	.045	.055	1.14	1.40
b2	.075	.087	1.91	2.20
b4	.115	.126	2.92	3.20
C	.024	.031	0.61	0.80
D	.819	.840	20.80	21.34
D1	.650	.690	16.51	17.53
D2	.035	.050	0.89	1.27
E	.620	.635	15.75	16.13
E1	.545	.565	13.84	14.35
e	.215 BSC		5.45 BSC	
J	—	.010	—	0.25
K	—	.025	—	0.64
L	.780	.810	19.81	20.57
L1	.150	.170	3.81	4.32
∅P	.140	.144	3.55	3.65
∅P1	.275	.290	6.99	7.37
Q	.220	.244	5.59	6.20
R	.170	.190	4.32	4.83
S	.242 BSC		6.15 BSC	



---

Disclaimer Notice - Information furnished is believed to be accurate and reliable. However, users should independently evaluate the suitability of and test each product selected for their own applications. Littelfuse products are not designed for, and may not be used in, all applications. Read complete Disclaimer Notice at [www.littelfuse.com/disclaimer-electronics](http://www.littelfuse.com/disclaimer-electronics).



# Mouser Electronics

Authorized Distributor

Click to View Pricing, Inventory, Delivery & Lifecycle Information:

[IXYS:](#)

[IXGA48N60C3-TRL](#)