

Power MOSFET

TO-220AB

N-Channel MOSFET

FEATURES

- Extremely low $R_{DS(on)}$
- Compact plastic package
- Fast switching
- Low drive current
- Ease of paralleling
- Excellent temperature stability
- Parts per million quality
- Material categorization: for definitions of compliance please see www.vishay.com/doc?99912



Note

* This datasheet provides information about parts that are RoHS-compliant and / or parts that are non RoHS-compliant. For example, parts with lead (Pb) terminations are not RoHS-compliant. Please see the information / tables in this datasheet for details

PRODUCT SUMMARY	
V_{DS} (V)	50
$R_{DS(on)}$ (Ω)	$V_{GS} = 10\text{ V}$ 0.10
Q_g (Max.) (nC)	17
Q_{gs} (nC)	9.0
Q_{gd} (nC)	3.0
Configuration	Single

DESCRIPTION

The technology has expanded its product base to serve the low voltage, very low $R_{DS(on)}$ MOSFET transistor requirements. Vishay's highly efficient geometry and unique processing have been combined to create the lowest on resistance per device performance. In addition to this feature all have documented reliability and parts per million quality!

The transistor also offer all of the well established advantages of MOSFETs such as voltage control, very fast switching, ease of paralleling, and temperature stability of the electrical parameters.

They are well suited for applications such as switching power supplies, motor controls, inverters, choppers, audio amplifiers, high energy pulse circuits, and in systems that are operated from low voltage batteries, such as automotive, portable equipment, etc.

ORDERING INFORMATION	
Package	TO-220AB
Lead (Pb)-free	IRFZ20PbF
Lead (Pb)-free and halogen-free	IRFZ20PbF-BE3

ABSOLUTE MAXIMUM RATINGS				
PARAMETER	SYMBOL	LIMIT	UNIT	
Drain-source voltage ^a	V_{DS}	50	V	
Gate-source voltage ^a	V_{GS}	± 20		
Continuous drain current	V_{GS} at 10 V	$T_C = 25\text{ }^\circ\text{C}$	A	
		$T_C = 100\text{ }^\circ\text{C}$		
Pulsed drain current ^b	I_{DM}	60		
Single pulse avalanche energy ^c	E_{AS}	5	mJ	
Linear derating factor (see fig. 16)		0.32	W/ $^\circ\text{C}$	
Maximum power dissipation (see fig. 16)	$T_C = 25\text{ }^\circ\text{C}$	P_D	40	W
Operating junction and storage temperature range	T_J, T_{stg}	-55 to +150	$^\circ\text{C}$	
Soldering recommendations (peak temperature)	For 10 s	300 (0.063" (1.6 mm) from case)		

Notes

- $T_J = 25\text{ }^\circ\text{C}$ to $150\text{ }^\circ\text{C}$
- Repetitive rating: Pulse width limited by max. junction temperature. See transient temperature impedance curve (see fig. 11)
- Starting $T_J = 25\text{ }^\circ\text{C}$, $L = 0.07\text{ mH}$, $R_g = 25\text{ }^\circ\Omega$, $I_{AS} = 12\text{ A}$

THERMAL RESISTANCE RATINGS				
PARAMETER	SYMBOL	TYP.	MAX.	UNIT
Typical socket mount, junction-to-ambient	R_{thJA}	-	80	°C/W
Case-to-sink, mounting surface flat, smooth, and greased	R_{thCS}	1.0	-	
Junction-to-case	R_{thJC}	-	3.12	

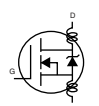
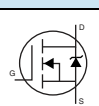
SPECIFICATIONS ($T_J = 25\text{ }^\circ\text{C}$, unless otherwise noted)							
PARAMETER	SYMBOL	TEST CONDITIONS		MIN.	TYP.	MAX.	UNIT
Static							
Drain-source breakdown voltage	V_{DS}	$V_{GS} = 0\text{ V}$, $I_D = 250\text{ }\mu\text{A}$		50	-	-	V
V_{DS} temperature coefficient	$V_{GS(th)}$	$V_{DS} = V_{GS}$, $I_D = 250\text{ }\mu\text{A}$		2.0	-	4.0	V
Gate-source threshold voltage	I_{GSS}	$V_{GS} = \pm 20\text{ V}$		-	-	± 500	nA
Gate-source leakage	I_{DSS}	$V_{DS} > \text{Max. Rating}$, $V_{GS} = 0\text{ V}$		-	-	250	μA
Zero gate voltage drain current		$V_{DS} = \text{Max. Rating} \times 0.8$, $V_{GS} = 0\text{ V}$, $T_C = 125\text{ }^\circ\text{C}$		-	-	1000	
	$I_{D(on)}$	$V_{GS} = 10\text{ V}$	$V_{DS} > I_{D(on)} \times R_{DS(on)}$ max.	-	-	15	A
Drain-source on-state resistance ^b	$R_{DS(on)}$	$V_{GS} = 10\text{ V}$	$I_D = 10\text{ A}$	-	0.080	0.10	Ω
Forward transconductance ^b	g_{fs}	$V_{DS} > I_{D(on)} \times R_{DS(on)}$ max., $I_D = 9.0\text{ A}$		5.0	6.0	-	S
Dynamic							
Input capacitance	C_{iss}	$V_{GS} = 0\text{ V}$, $V_{DS} = 25\text{ V}$, $f = 1.0\text{ MHz}$, see fig. 11		-	560	860	pF
Output capacitance	C_{oss}			-	250	350	
Reverse transfer capacitance	C_{rss}			-	60	100	
Total gate charge	Q_g	$V_{GS} = 10\text{ V}$	$I_D = 20\text{ A}$, $V_{DS} = 0.8$ max. rating, see fig. 18 for test circuit (Gate charge is essentially independent of operating temperature)	-	12	17	nC
Gate-source charge	Q_{gs}			-	9.0	-	
Gate-drain charge	Q_{gd}			-	3.0	-	
Turn-on delay time	$t_{d(on)}$	$V_{DD} = 25\text{ V}$, $I_D = 9.0\text{ A}$, $Z_0 = 50\text{ }\Omega$, see fig. 5 ^b		-	15	30	ns
Rise time	t_r			-	45	90	
Turn-off delay time	$t_{d(off)}$			-	20	40	
Fall time	t_f			-	15	30	
Internal drain inductance	L_D	Modified MOSFET symbol showing the internal device inductances 		-	3.5	-	nH
Internal source inductance	L_S			-	4.5	-	
Drain-Source Body Diode Characteristics							
Continuous source-drain diode current	I_S	MOSFET symbol showing the integral reverse p-n junction rectifier 		-	-	15	A
Pulsed diode forward current ^a	I_{SM}			-	-	60	
Body diode voltage ^b	V_{SD}	$T_C = 25\text{ }^\circ\text{C}$, $I_S = 15\text{ A}$, $V_{GS} = 0\text{ V}$		-	-	1.5	V
Body diode reverse recovery time	t_{rr}	$T_J = 150\text{ }^\circ\text{C}$, $I_F = 15\text{ A}$, $dI_F/dt = 100\text{ A}/\mu\text{s}$		-	100	-	ns
Body diode reverse recovery charge	Q_{rr}			-	0.4	-	μC
Forward turn-on time	t_{on}	Intrinsic turn-on time is negligible (turn-on is dominated by L_S and L_D)					

Notes

- a. Repetitive rating: Pulse width limited by max. junction temperature. See transient temperature impedance curve (see fig. 5)
 b. Pulse test: Pulse width $\leq 300\text{ }\mu\text{s}$; duty cycle $\leq 2\%$

TYPICAL CHARACTERISTICS (25 °C, unless otherwise noted)

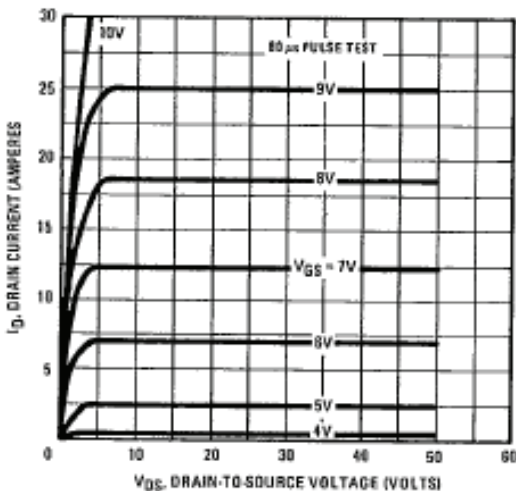

Fig. 1 - Typical Output Characteristics

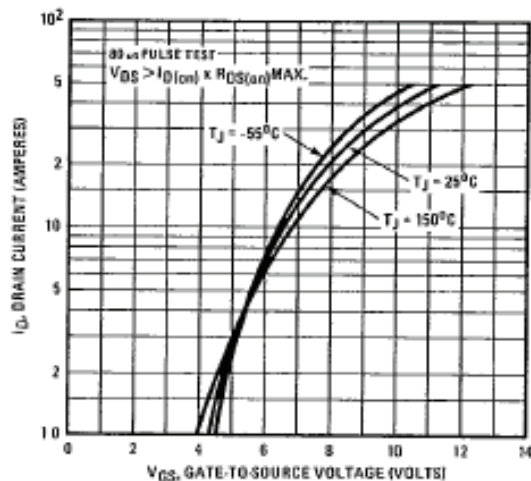

Fig. 1 - Typical Transfer Characteristics

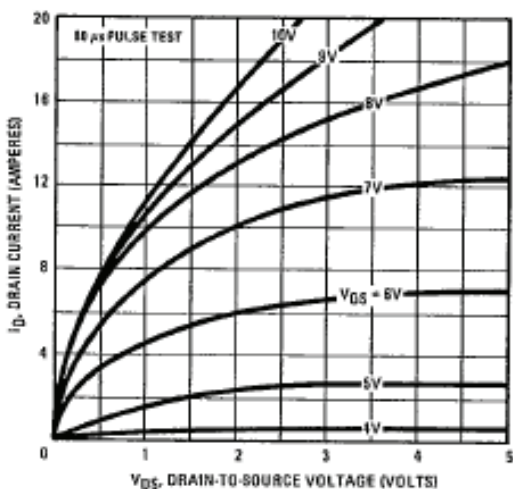

Fig. 2 - Typical Saturation Characteristics

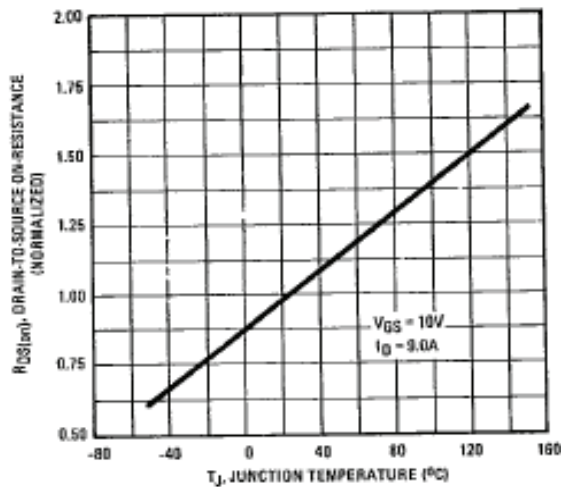

Fig. 2 - Normalized On-Resistance vs. Temperature

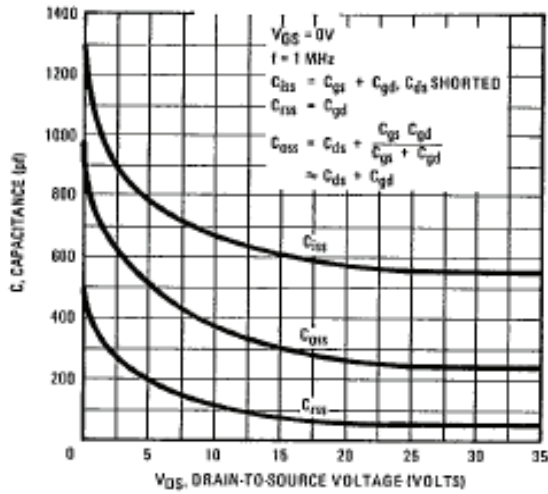

Fig. 3 - Typical Capacitance vs. Drain-to-Source Voltage

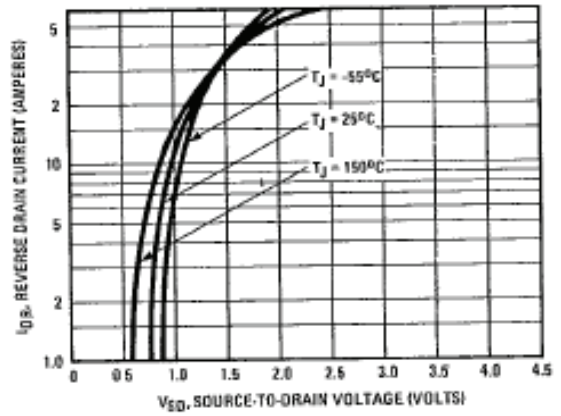

Fig. 5 - Typical Source-Drain Diode Forward Voltage

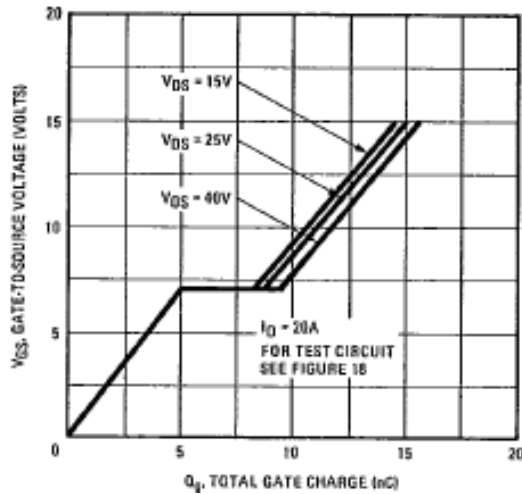

Fig. 4 - Typical Gate Charge vs. Gate-to-Source Voltage

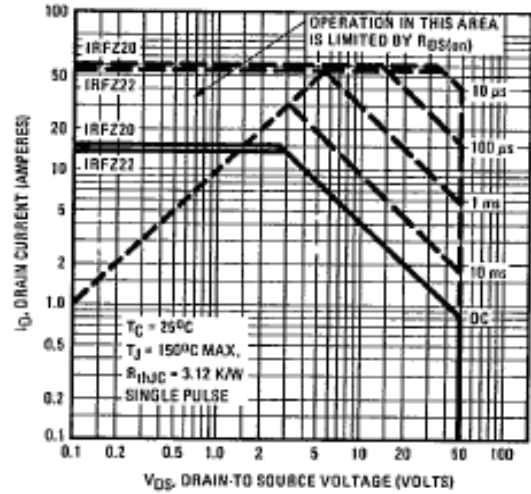

Fig. 6 - Maximum Safe Operating Area

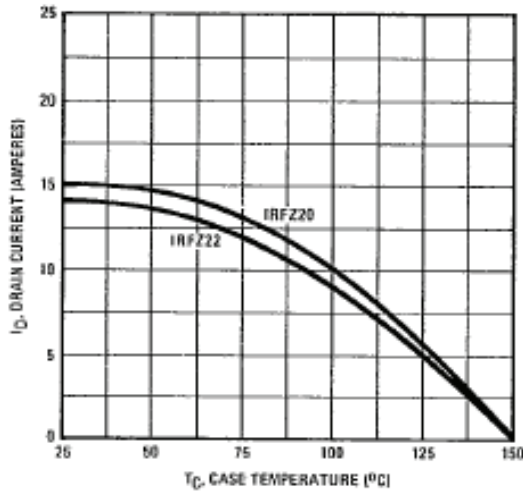

Fig. 7 - Maximum Drain Current vs. Case Temperature

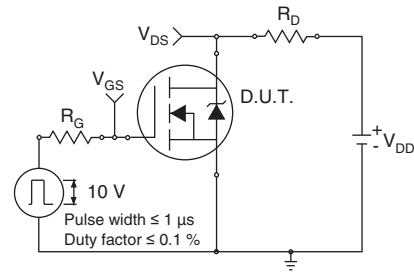

Fig. 10a - Switching Time Test Circuit



Fig. 10b - Switching Time Waveforms

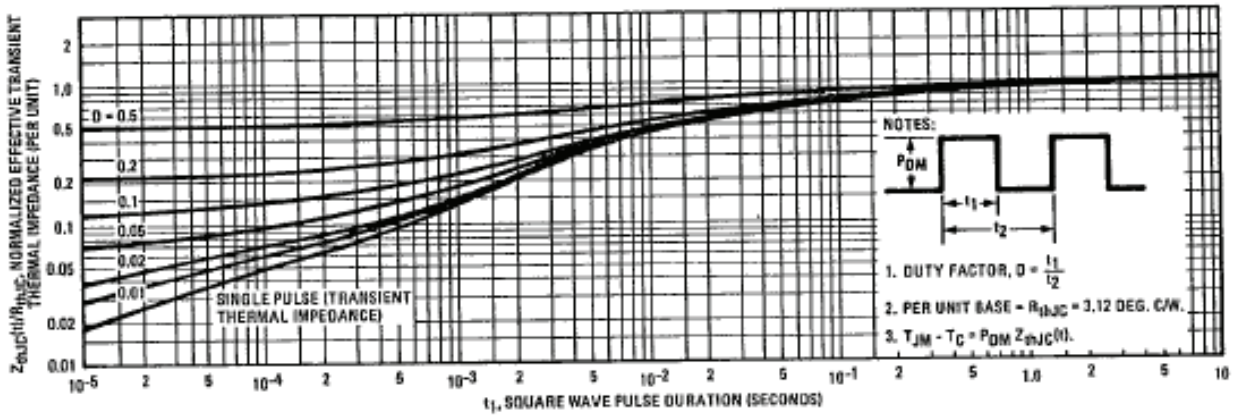

Fig. 11 - Maximum Effective Transient Thermal Impedance, Junction-to-Case vs. Pulse Duration

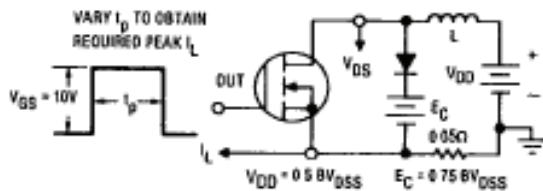

Fig. 12a - Clamped Inductive Test Circuit

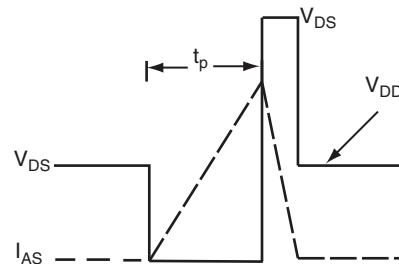

Fig. 12b - Unclamped Inductive Waveforms

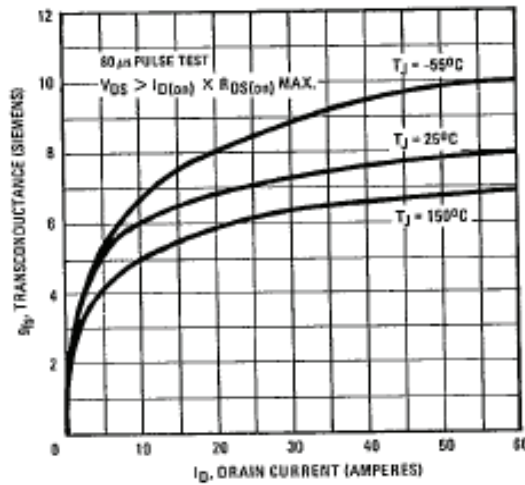

Fig. 13 - Typical Transconductance vs. Drain Current

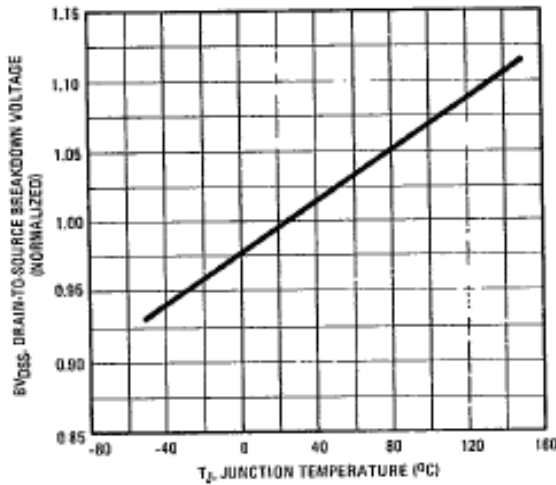

Fig. 14 - Breakdown Voltage vs. Temperature

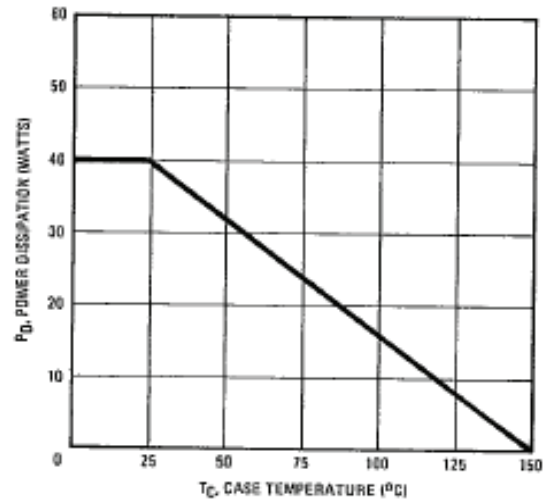

Fig. 16 - Power vs. Temperature Derating Curve

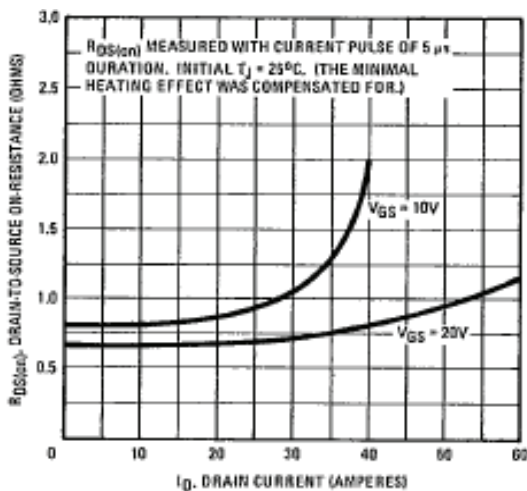

Fig. 15 - Typical On-Resistance vs. Drain Current

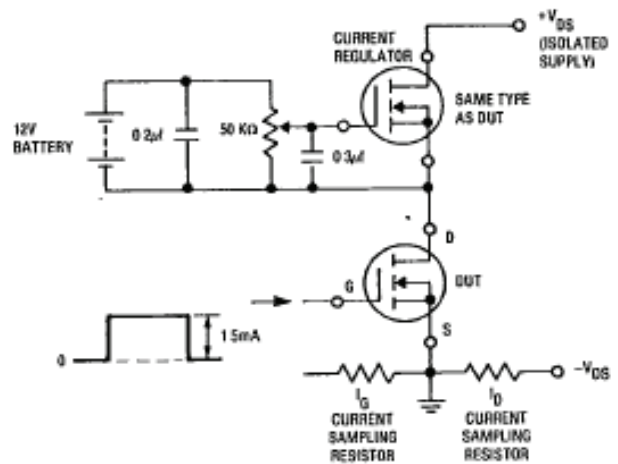
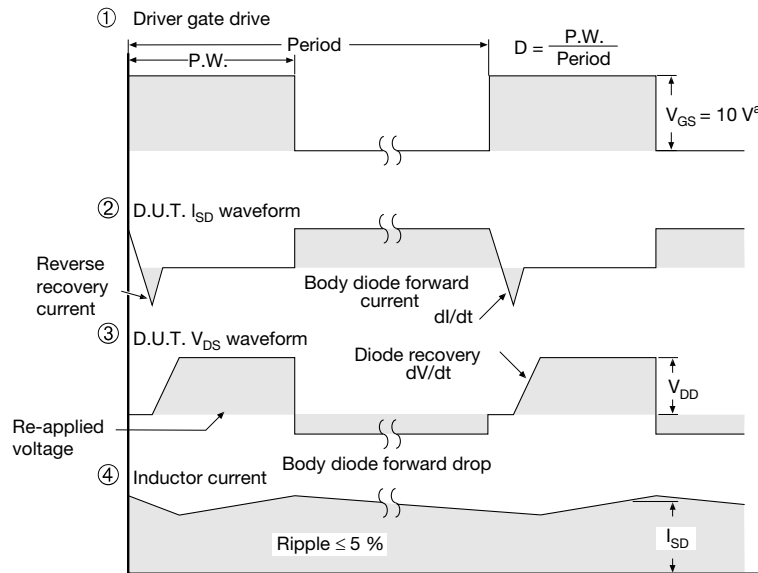
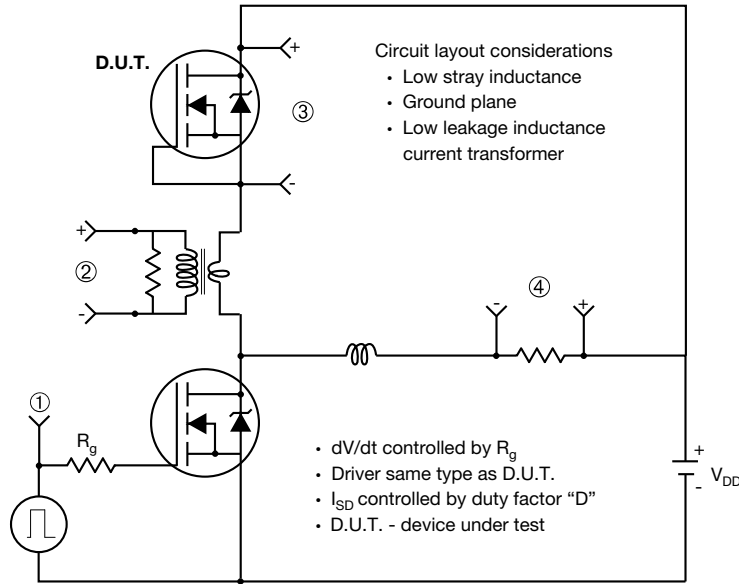

Fig. 17 - Gate Charge Test Circuit

Peak Diode Recovery dV/dt Test Circuit



Note

a. $V_{GS} = 5\text{ V}$ for logic level devices

Fig. 14 - For N-Channel

Vishay Siliconix maintains worldwide manufacturing capability. Products may be manufactured at one of several qualified locations. Reliability data for Silicon Technology and Package Reliability represent a composite of all qualified locations. For related documents such as package/tape drawings, part marking, and reliability data, see <http://www.vishay.com/ppg?91340>.



Disclaimer

ALL PRODUCT, PRODUCT SPECIFICATIONS AND DATA ARE SUBJECT TO CHANGE WITHOUT NOTICE TO IMPROVE RELIABILITY, FUNCTION OR DESIGN OR OTHERWISE.

Vishay Intertechnology, Inc., its affiliates, agents, and employees, and all persons acting on its or their behalf (collectively, "Vishay"), disclaim any and all liability for any errors, inaccuracies or incompleteness contained in any datasheet or in any other disclosure relating to any product.

Vishay makes no warranty, representation or guarantee regarding the suitability of the products for any particular purpose or the continuing production of any product. To the maximum extent permitted by applicable law, Vishay disclaims (i) any and all liability arising out of the application or use of any product, (ii) any and all liability, including without limitation special, consequential or incidental damages, and (iii) any and all implied warranties, including warranties of fitness for particular purpose, non-infringement and merchantability.

Statements regarding the suitability of products for certain types of applications are based on Vishay's knowledge of typical requirements that are often placed on Vishay products in generic applications. Such statements are not binding statements about the suitability of products for a particular application. It is the customer's responsibility to validate that a particular product with the properties described in the product specification is suitable for use in a particular application. Parameters provided in datasheets and / or specifications may vary in different applications and performance may vary over time. All operating parameters, including typical parameters, must be validated for each customer application by the customer's technical experts. Product specifications do not expand or otherwise modify Vishay's terms and conditions of purchase, including but not limited to the warranty expressed therein.

Hyperlinks included in this datasheet may direct users to third-party websites. These links are provided as a convenience and for informational purposes only. Inclusion of these hyperlinks does not constitute an endorsement or an approval by Vishay of any of the products, services or opinions of the corporation, organization or individual associated with the third-party website. Vishay disclaims any and all liability and bears no responsibility for the accuracy, legality or content of the third-party website or for that of subsequent links.

Vishay products are not designed for use in life-saving or life-sustaining applications or any application in which the failure of the Vishay product could result in personal injury or death unless specifically qualified in writing by Vishay. Customers using or selling Vishay products not expressly indicated for use in such applications do so at their own risk. Please contact authorized Vishay personnel to obtain written terms and conditions regarding products designed for such applications.

No license, express or implied, by estoppel or otherwise, to any intellectual property rights is granted by this document or by any conduct of Vishay. Product names and markings noted herein may be trademarks of their respective owners.