

GW PUSRA1.PM

OSCONIQ® P 3737 (2W)

High-power LED with high performance, superior robustness and long lifetime.

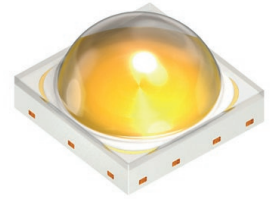

Applications

- Architecture
- Area Lights
- Highbay Industrial
- Street, Tunnel and Outdoor

Features:

- Package: New SMD epoxy package with silicone lens
- Typ. Radiation: 120° (Lambertian emitter)
- Corrosion Robustness Class: 3B
- Color temperature: 3000K - 6500K
- CRI: 70 (min.), 72 (typ.), R9: -50 (min.)
- ESD: 8 kV acc. to ANSI/ESDA/JEDEC JS-001 (HBM, Class 3B)
- Luminous Flux: typ. 333 lm @ 5000 K, 85 °C
- Luminous efficacy: typ. 169 lm/W @ 5000 K, 85 °C

Ordering Information

Type	Color temperature	Luminous Flux ¹⁾ $I_F = 700 \text{ mA}$ Φ_v	Ordering Code
GW PUSRA1.PM-N3N9-XX57-1	3000 K	300 ... 370 lm	Q65112A8656
GW PUSRA1.PM-N3N5-XX56-1	3500 K	300 ... 330 lm	Q65112A7906
GW PUSRA1.PM-N4P1-XX56-1	3500 K	310 ... 380 lm	Q65112A8658
GW PUSRA1.PM-N4P1-XX55-1	4000 K	310 ... 380 lm	Q65112A8812
GW PUSRA1.PM-N4P1-XX54-1	4500 K	310 ... 380 lm	Q65112A8651
GW PUSRA1.PM-N4N6-XX53-1	5000 K	310 ... 340 lm	Q65112A6202
GW PUSRA1.PM-N5P2-XX53-1	5000 K	320 ... 390 lm	Q65112A8645
GW PUSRA1.PM-N4N6-XX52-1	5700 K	310 ... 340 lm	Q65112A6200
GW PUSRA1.PM-N5P2-XX52-1	5700 K	320 ... 390 lm	Q65112A8647
GW PUSRA1.PM-N4P1-XX51-1	6500 K	310 ... 380 lm	Q65112A8643

Maximum Ratings

Parameter	Symbol		Values
Operating Temperature	T_{op}	min.	-40 °C
		max.	125 °C
Storage Temperature	T_{stg}	min.	-40 °C
		max.	125 °C
Junction Temperature	T_j	max.	135 °C
Forward Current $T_j = 85\text{ °C}$	I_F	min.	100 mA
		max.	1500 mA
Surge Current $t \leq 10\ \mu\text{s}$; $D = 0.005$; $T_j = 85\text{ °C}$	I_{FS}	max.	2000 mA
Reverse voltage ²⁾	V_R		Not designed for reverse operation
ESD withstand voltage acc. to ANSI/ESDA/JEDEC JS-001 (HBM, Class 3B)	V_{ESD}		8 kV

Characteristics

$I_F = 700 \text{ mA}$; $T_J = 85 \text{ °C}$

Parameter	Symbol		Values
Viewing angle at 50% I_V	2ϕ	typ.	120 °
Forward Voltage ³⁾ $I_F = 700 \text{ mA}$	V_F	min. typ. max.	2.70 V 2.80 V 3.20 V
Reverse current ²⁾	I_R		Not designed for reverse operation
Color Rendering Index ⁴⁾ (3000K - 6500K)	CRI	min. typ.	70 72
Color Rendering Index (R9) ⁴⁾	CRI (R9)	min.	-50
Electrical thermal resistance junction/solderpoint with efficiency $\eta_e = 43 \%$	$R_{thJS \text{ elec.}}$	typ.	2.8 K / W

Brightness Groups

Group	Luminous Flux ¹⁾ $I_F = 700 \text{ mA}$ min. Φ_V	Luminous Flux ¹⁾ $I_F = 700 \text{ mA}$ max. Φ_V
N3	300 lm	310 lm
N4	310 lm	320 lm
N5	320 lm	330 lm
N6	330 lm	340 lm
N7	340 lm	350 lm
N8	350 lm	360 lm
N9	360 lm	370 lm
P1	370 lm	380 lm
P2	380 lm	390 lm

Forward Voltage Groups

Group	Forward Voltage ³⁾ $I_F = 700 \text{ mA}$ min. V_F	Forward Voltage ³⁾ $I_F = 700 \text{ mA}$ max. V_F
K2	2.70 V	2.80 V
L1	2.80 V	2.90 V
L2	2.90 V	3.00 V
M1	3.00 V	3.10 V
M2	3.10 V	3.20 V

Chromaticity Coordinate Groups ⁵⁾



Chromaticity Coordinate Groups

CCT	Center Cx	Center Cy	3step a	3step b	5step a	5step b	∅
3000 K	0.4339	0.4032	0.0086	0.0042	0.0142	0.0069	53.7
3500 K	0.4077	0.3929	0.0093	0.0042	0.0155	0.0069	53.9
4000 K	0.3818	0.3796	0.0094	0.0041	0.0157	0.0068	53.4
4500 K	0.3613	0.3669	0.0089	0.0038	0.0148	0.0063	57
5000 K	0.3446	0.3551	0.0081	0.0035	0.0135	0.0059	59.8
5700 K	0.3287	0.3425	0.0072	0.0032	0.0119	0.0052	58.8
6500 K	0.3123	0.3282	0.0066	0.0027	0.0110	0.0045	58.1

CCT	Group	1		2		3		4		5	
		Cx	Cy	Cx	Cy	Cx	Cy	Cx	Cy	Cx	Cy
3000 K	A	0.4418	0.4211	0.4302	0.4171	0.4226	0.3995	0.4246	0.4002	0.4393	0.4153
	B	0.4418	0.4211	0.4561	0.4259	0.4465	0.4073	0.4432	0.4062	0.4393	0.4153
	C	0.4465	0.4073	0.4372	0.3892	0.4261	0.3856	0.4285	0.3911	0.4432	0.4062
	D	0.4285	0.3911	0.4246	0.4002	0.4226	0.3995	0.4149	0.3819	0.4261	0.3856
	E	0.4393	0.4153	0.4246	0.4002	0.4283	0.4014	0.4371	0.4105		
	F	0.4393	0.4153	0.4432	0.4062	0.4395	0.4050	0.4371	0.4105		
	G	0.4432	0.4062	0.4285	0.3911	0.4307	0.3960	0.4395	0.4050		
	H	0.4307	0.3960	0.4283	0.4014	0.4246	0.4002	0.4285	0.3911		
3500 K	A	0.4131	0.4093	0.4003	0.4034	0.3949	0.3871	0.3977	0.3883	0.4118	0.4054
	B	0.4131	0.4093	0.4302	0.4171	0.4227	0.3997	0.4177	0.3975	0.4118	0.4054
	C	0.4227	0.3997	0.4149	0.3819	0.4022	0.3763	0.4036	0.3804	0.4177	0.3975
	D	0.4036	0.3804	0.3977	0.3883	0.3949	0.3871	0.3895	0.3707	0.4022	0.3763
	E	0.4118	0.4054	0.3977	0.3883	0.4017	0.3902	0.4102	0.4004		
	F	0.4118	0.4054	0.4177	0.3975	0.4137	0.3957	0.4102	0.4004		
	G	0.4177	0.3975	0.4036	0.3804	0.4052	0.3854	0.4137	0.3957		
	H	0.4052	0.3854	0.4017	0.3902	0.3977	0.3883	0.4036	0.3804		
4000 K	A	0.3853	0.3947	0.3737	0.3879	0.3704	0.3731	0.3714	0.3737	0.3845	0.3913
	B	0.3853	0.3947	0.4003	0.4034	0.3949	0.3871	0.3922	0.3855	0.3845	0.3913
	C	0.3949	0.3871	0.3895	0.3707	0.3783	0.3645	0.3791	0.3679	0.3922	0.3855
	D	0.3791	0.3679	0.3714	0.3737	0.3704	0.3731	0.3671	0.3583	0.3783	0.3645
	E	0.3845	0.3913	0.3714	0.3737	0.3756	0.3760	0.3834	0.3866		
	F	0.3845	0.3913	0.3922	0.3855	0.3880	0.3832	0.3834	0.3866		
	G	0.3922	0.3855	0.3791	0.3679	0.3802	0.3726	0.3880	0.3832		
	H	0.3802	0.3726	0.3756	0.3760	0.3714	0.3737	0.3791	0.3679		
4500 K	A	0.3634	0.3809	0.3550	0.3752	0.3538	0.3664	0.3629	0.3779		
	B	0.3634	0.3809	0.3737	0.3879	0.3709	0.3753	0.3629	0.3779		
	C	0.3695	0.3690	0.3671	0.3583	0.3593	0.3532	0.3597	0.3559		
	D	0.3597	0.3559	0.3524	0.3555	0.3514	0.3480	0.3593	0.3532		
	E	0.3629	0.3779	0.3538	0.3664	0.3532	0.3616	0.3557	0.3632	0.3623	0.3735
	F	0.3629	0.3779	0.3709	0.3753	0.3703	0.3728	0.3669	0.3706	0.3623	0.3735
	G	0.3703	0.3728	0.3695	0.3690	0.3597	0.3559	0.3603	0.3603	0.3669	0.3706
	H	0.3603	0.3603	0.3557	0.3632	0.3532	0.3616	0.3524	0.3555	0.3597	0.3559

5000 K	A	0.3452	0.3678	0.3375	0.3619	0.3372	0.3528	0.3451	0.3648		
	B	0.3452	0.3678	0.3550	0.3752	0.3532	0.3614	0.3530	0.3612	0.3451	0.3648
	C	0.3532	0.3614	0.3514	0.3480	0.3440	0.3426	0.3441	0.3454	0.3530	0.3612
	D	0.3441	0.3454	0.3369	0.3445	0.3366	0.3372	0.3440	0.3426		
	E	0.3451	0.3648	0.3372	0.3528	0.3371	0.3496	0.3396	0.3514	0.3449	0.3609
	F	0.3451	0.3648	0.3530	0.3612	0.3496	0.3588	0.3449	0.3609		
	G	0.3530	0.3612	0.3441	0.3454	0.3443	0.3493	0.3496	0.3588		
	H	0.3443	0.3493	0.3396	0.3514	0.3371	0.3496	0.3369	0.3445	0.3441	0.3454
5700 K	A	0.3280	0.3539	0.3205	0.3475	0.3212	0.3373	0.3283	0.3502		
	B	0.3280	0.3539	0.3375	0.3619	0.3370	0.3493	0.3363	0.3486	0.3283	0.3502
	C	0.3370	0.3493	0.3366	0.3372	0.3294	0.3314	0.3291	0.3348	0.3363	0.3486
	D	0.3291	0.3348	0.3215	0.3337	0.3221	0.3255	0.3294	0.3314		
	E	0.3283	0.3502	0.3212	0.3373	0.3213	0.3365	0.3242	0.3388	0.3284	0.3471
	F	0.3283	0.3502	0.3363	0.3486	0.3332	0.3462	0.3284	0.3471		
	G	0.3363	0.3486	0.3291	0.3348	0.3290	0.3379	0.3332	0.3462		
	H	0.3291	0.3348	0.3215	0.3337	0.3213	0.3365	0.3242	0.3388	0.3290	0.3379
6500 K	A	0.3102	0.3379	0.3027	0.3310	0.3047	0.3214	0.3054	0.3220	0.3110	0.3340
	B	0.3102	0.3379	0.3205	0.3475	0.3213	0.3363	0.3192	0.3344	0.3110	0.3340
	C	0.3213	0.3363	0.3221	0.3255	0.3144	0.3187	0.3136	0.3224	0.3192	0.3344
	D	0.3136	0.3224	0.3054	0.3220	0.3047	0.3214	0.3067	0.3118	0.3144	0.3187
	E	0.3110	0.3340	0.3054	0.3220	0.3082	0.3245	0.3115	0.3317		
	F	0.3110	0.3340	0.3192	0.3344	0.3165	0.3319	0.3115	0.3317		
	G	0.3192	0.3344	0.3136	0.3224	0.3131	0.3247	0.3165	0.3319		
	H	0.3136	0.3224	0.3054	0.3220	0.3082	0.3245	0.3131	0.3247		

Relative Spectral Emission ⁶⁾

$\Phi_{rel} = f(\lambda); I_F = 700 \text{ mA}; T_J = 85 \text{ }^\circ\text{C}$

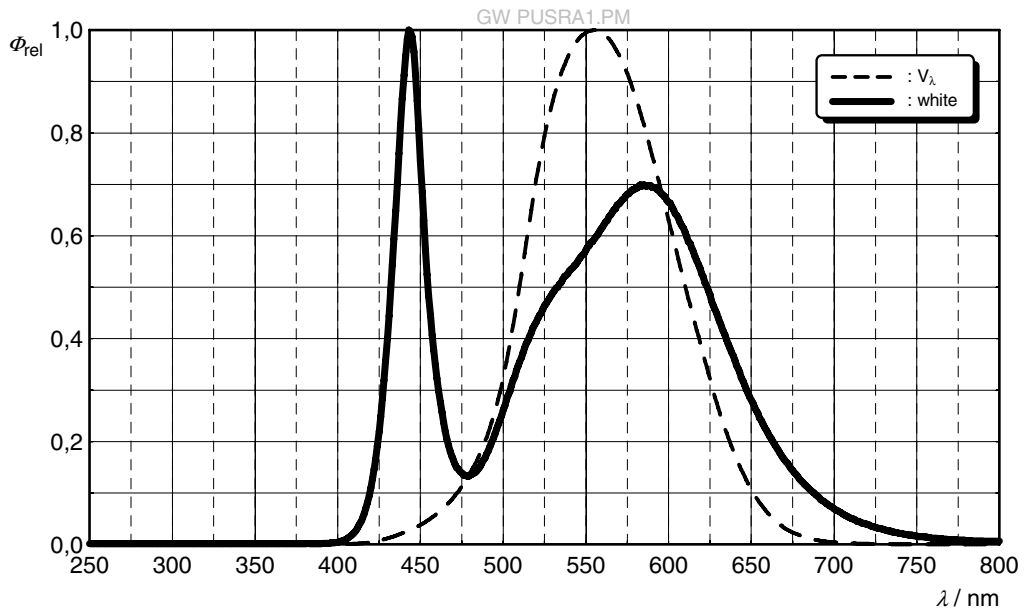

Radiation Characteristics ⁶⁾

$I_{rel} = f(\phi); T_J = 85 \text{ }^\circ\text{C}$

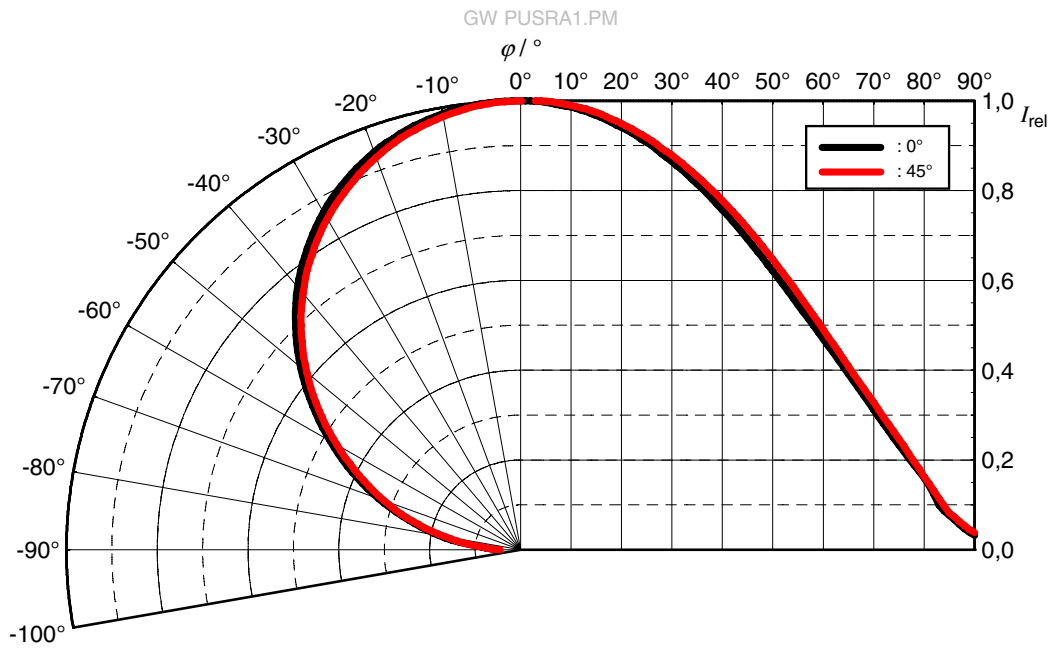

Forward current ⁶⁾

$I_F = f(V_F); T_J = 85 \text{ }^\circ\text{C}$

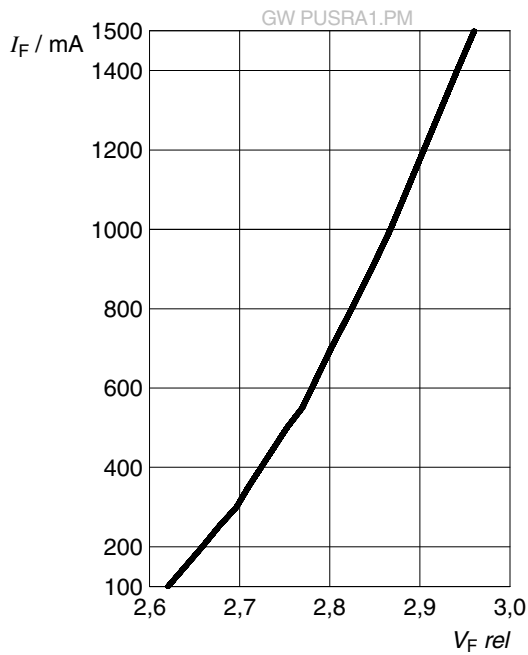

Relative Luminous Flux ^{6), 7)}

$\Phi_V / \Phi_V(700 \text{ mA}) = f(I_F); T_J = 85 \text{ }^\circ\text{C}$

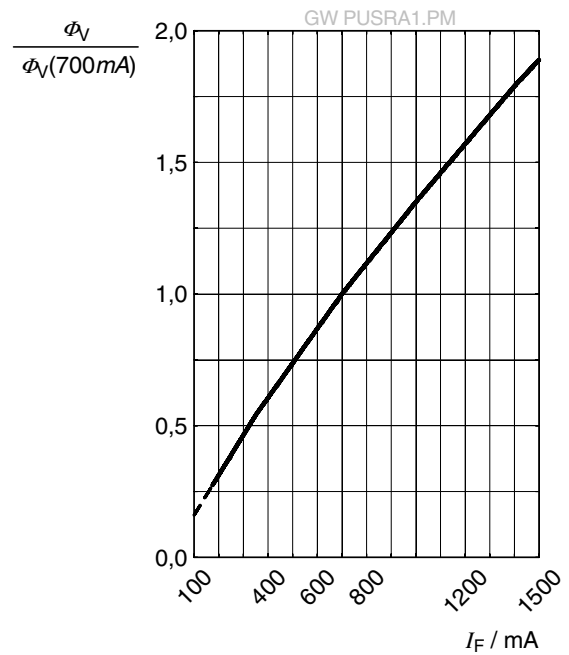

Chromaticity Coordinate Shift ⁶⁾

$\Delta Cx, \Delta Cy = f(I_F); T_J = 85 \text{ }^\circ\text{C}$

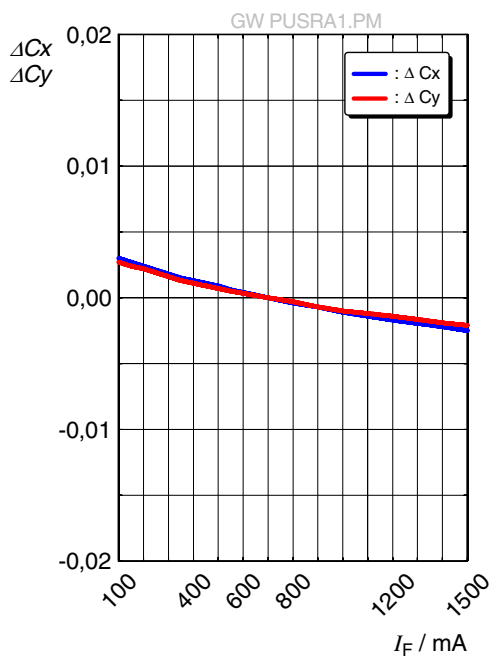

Forward Voltage ⁶⁾

$$\Delta V_F = V_F - V_F(85^\circ\text{C}) = f(T_j); I_F = 700\text{ mA}$$

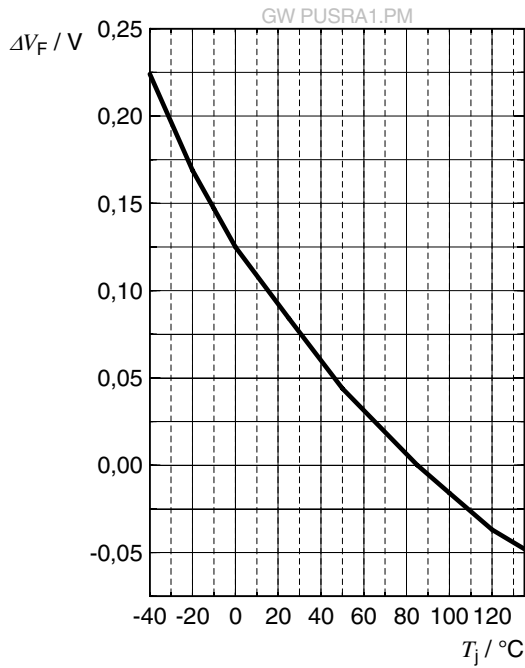

Relative Luminous Flux ⁶⁾

$$\Phi_V / \Phi_V(85^\circ\text{C}) = f(T_j); I_F = 700\text{ mA}$$

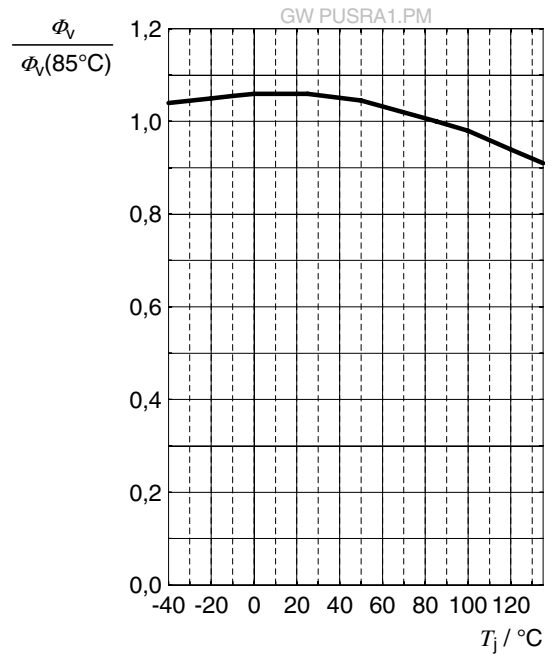

Chromaticity Coordinate Shift ⁶⁾

$$\Delta C_x, \Delta C_y = f(T_j); I_F = 700\text{ mA}$$

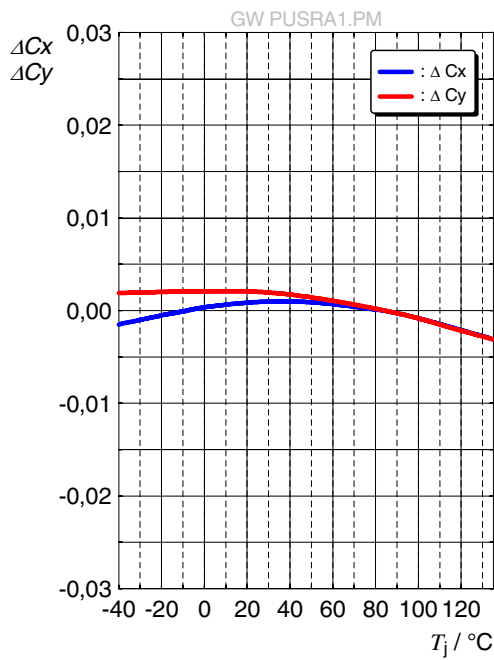

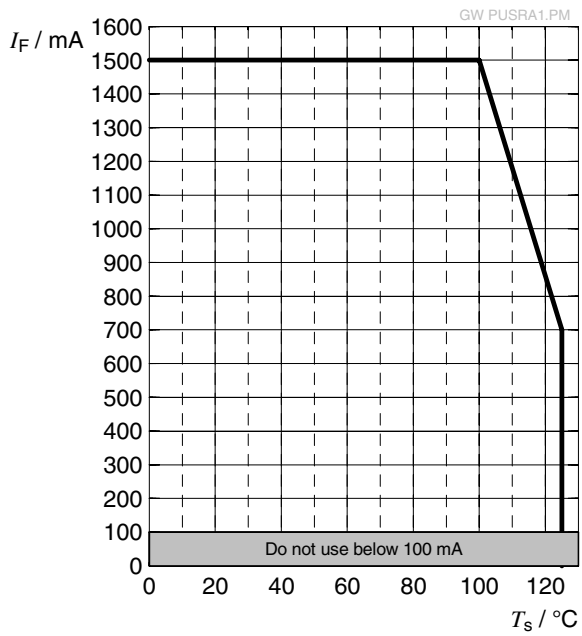

Max. Permissible Forward Current

$$I_F = f(T)$$

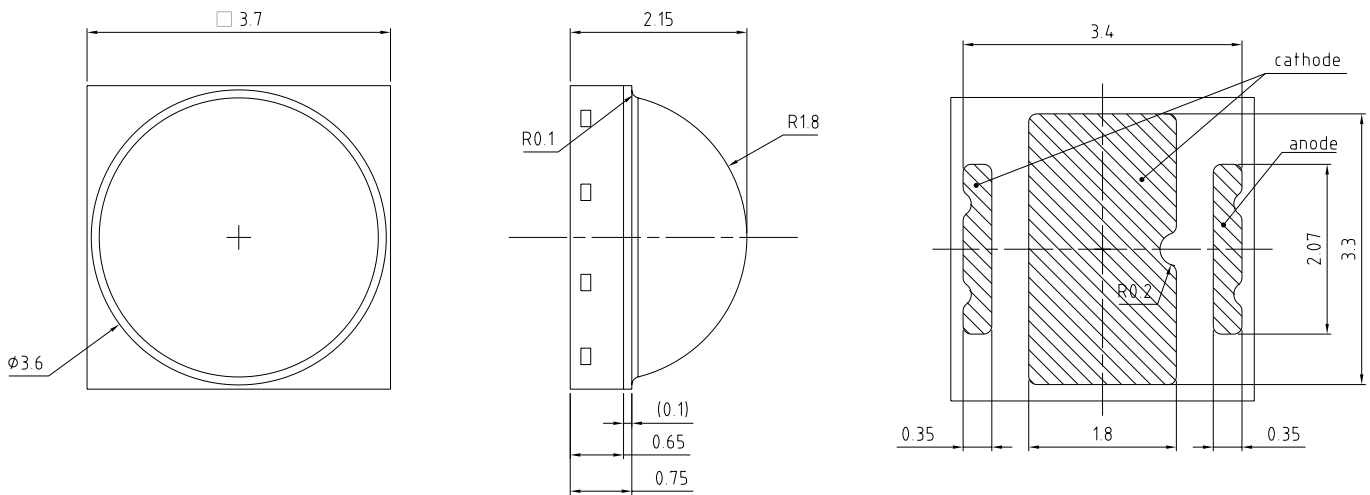

Dimensional Drawing 8)



General tolerance ± 0.1
 Lead finish Au 

C67062-A0172-A1-04

Further Information:

Approximate Weight: 43.0 mg

Package marking: Cathode

Corrosion test: Class: 3B
 Test condition: 40°C / 90 % RH / 15 ppm H₂S / 14 days (stricter than IEC 60068-2-43)

ESD advice: The device is protected by ESD device which is connected in parallel to the Chip.

Recommended Solder Pad ⁸⁾

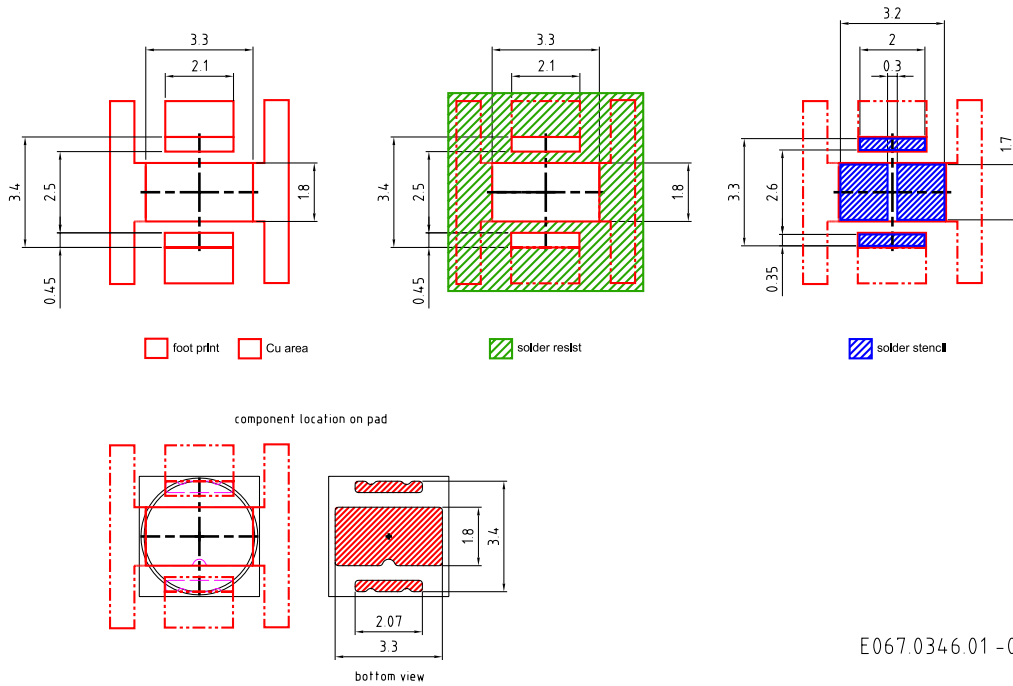

E067.0346.01 -05

For superior solder joint connectivity results we recommend soldering under standard nitrogen atmosphere. Package not suitable for ultra sonic cleaning.

Reflow Soldering Profile

Product complies to MSL Level 2 acc. to JEDEC J-STD-020E

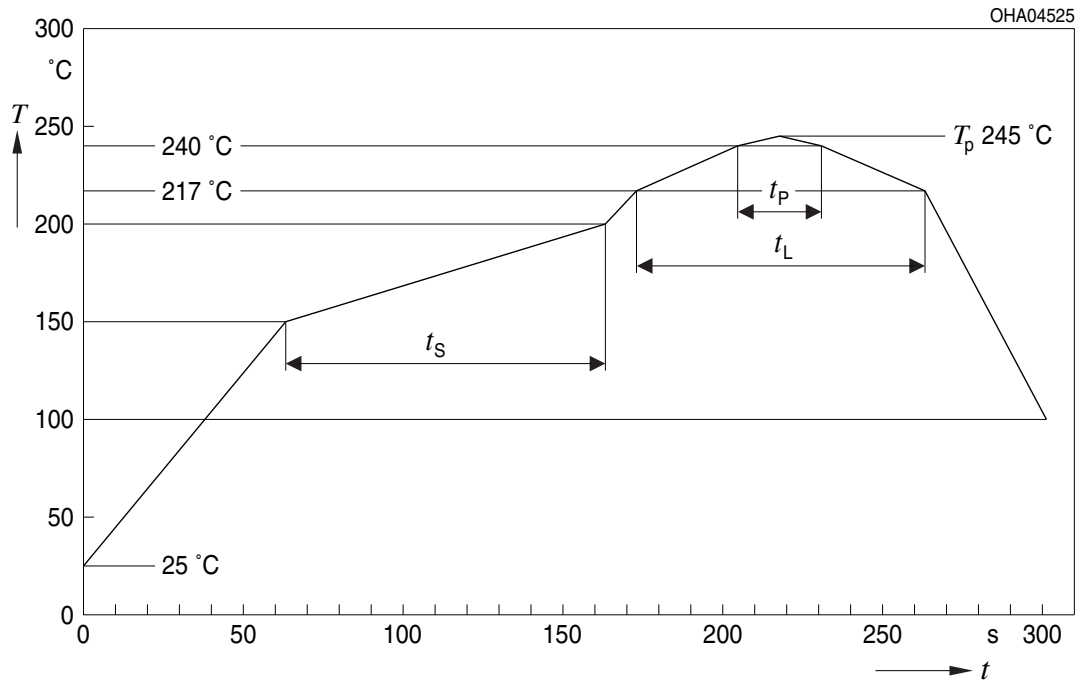

Profile Feature	Symbol	Pb-Free (SnAgCu) Assembly			Unit
		Minimum	Recommendation	Maximum	
Ramp-up rate to preheat ^{*)} 25 °C to 150 °C			2	3	K/s
Time t_s T_{Smin} to T_{Smax}	t_s	60	100	120	s
Ramp-up rate to peak ^{*)} T_{Smax} to T_p			2	3	K/s
Liquidus temperature	T_L		217		°C
Time above liquidus temperature	t_L		80	100	s
Peak temperature	T_p		245	260	°C
Time within 5 °C of the specified peak temperature $T_p - 5$ K	t_p	10	20	30	s
Ramp-down rate* T_p to 100 °C			3	6	K/s
Time 25 °C to T_p				480	s

All temperatures refer to the center of the package, measured on the top of the component
 *) slope calculation DT/Dt : Dt max. 5 s; fulfillment for the whole T-range

Taping ⁸⁾

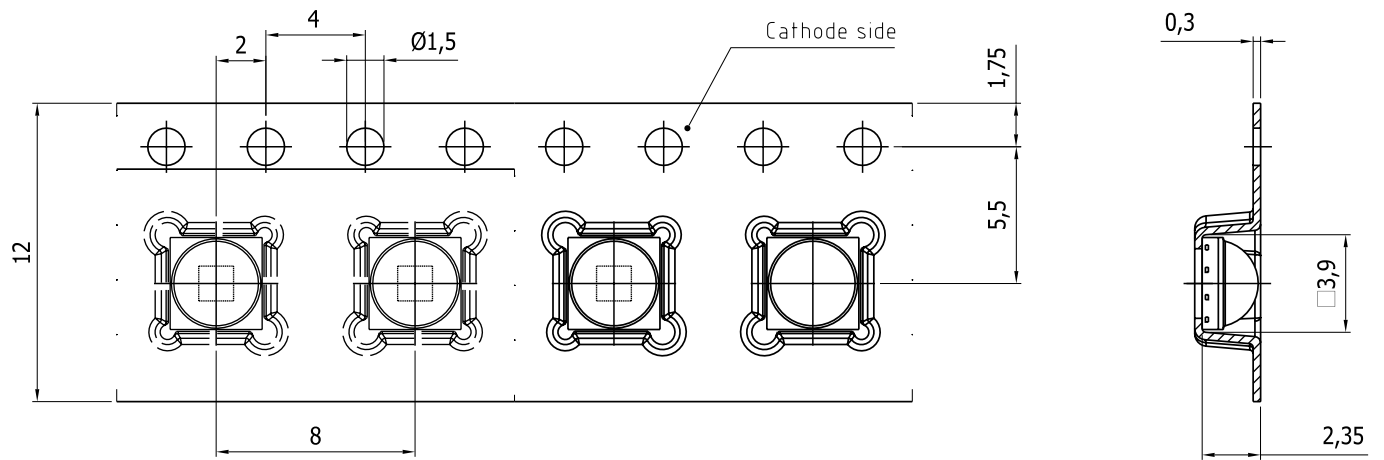

C67062-A0172-B11-01

Tape and Reel ⁹⁾



Reel Dimensions

A	W	N _{min}	W ₁	W _{2max}	Pieces per PU
180 mm	12 + 0.3 / - 0.1 mm	60 mm	12.4 + 2 mm	18.4 mm	600

Barcode-Product-Label (BPL)

OSRAM Opto Semiconductors LX XXXX BIN1: XX-XX-X-XXX-X

RoHS Compliant

(6P) BATCH NO: 1234567890

(1T) LOT NO: 1234567890 (9D) D/C: 1234

(X) PROD NO: 123456789(Q)QTY: 9999 (G) GROUP: XX-XX-X-X

ML Temp ST
X XXX °C X

Pack: RXX
DEMY XXX
X_X123_1234.1234 X



The diagram shows a rectangular label with rounded corners. It contains the OSRAM logo and name, a part number (LX XXXX), and a bin number (BIN1: XX-XX-X-XXX-X). It features three horizontal barcodes: a 6-digit batch number, a 1-digit lot number, and an (X) product number. A QR code is located on the right side. A 'No Moisture' symbol (a circle with a diagonal line and three drops) is placed above the QR code. Text fields include 'RoHS Compliant', 'ML Temp ST X XXX °C X', 'Pack: RXX', 'DEMY XXX', and 'X_X123_1234.1234 X'. A large 'EXAMPLE' watermark is overlaid diagonally across the label.

OHA04563

Dry Packing Process and Materials ⁸⁾



OHA00539

Moisture-sensitive product is packed in a dry bag containing desiccant and a humidity card according JEDEC-STD-033.

Notes

The evaluation of eye safety occurs according to the standard IEC 62471:2006 (photo biological safety of lamps and lamp systems). Within the risk grouping system of this IEC standard, the device specified in this data sheet fall into the class **moderate risk (exposure time 0.25 s)**. Under real circumstances (for exposure time, conditions of the eye pupils, observation distance), it is assumed that no endangerment to the eye exists from these devices. As a matter of principle, however, it should be mentioned that intense light sources have a high secondary exposure potential due to their blinding effect. When looking at bright light sources (e.g. headlights), temporary reduction in visual acuity and afterimages can occur, leading to irritation, annoyance, visual impairment, and even accidents, depending on the situation.

Subcomponents of this device contain, in addition to other substances, metal filled materials including silver. Metal filled materials can be affected by environments that contain traces of aggressive substances. Therefore, we recommend that customers minimize device exposure to aggressive substances during storage, production, and use. Devices that showed visible discoloration when tested using the described tests above did show no performance deviations within failure limits during the stated test duration. Respective failure limits are described in the IEC60810.

This device is designed for specific/recommended applications only. Please consult OSRAM Opto Semiconductors Sales Staff in advance for detailed information on other non-recommended applications (e.g. automotive).

Change management for this component is aligned with the requirements of the lighting market.

For further application related information please visit www.osram-os.com/appnotes

Disclaimer

Attention please!

The information describes the type of component and shall not be considered as assured characteristics. Terms of delivery and rights to change design reserved. Due to technical requirements components may contain dangerous substances.

For information on the types in question please contact our Sales Organization.

If printed or downloaded, please find the latest version on the OSRAM OS website.

Packing

Please use the recycling operators known to you. We can also help you – get in touch with your nearest sales office. By agreement we will take packing material back, if it is sorted. You must bear the costs of transport. For packing material that is returned to us unsorted or which we are not obliged to accept, we shall have to invoice you for any costs incurred.

Product and functional safety devices/applications or medical devices/applications

OSRAM OS components are not developed, constructed or tested for the application as safety relevant component or for the application in medical devices.

OSRAM OS products are not qualified at module and system level for such application.

In case buyer – or customer supplied by buyer – considers using OSRAM OS components in product safety devices/applications or medical devices/applications, buyer and/or customer has to inform the local sales partner of OSRAM OS immediately and OSRAM OS and buyer and /or customer will analyze and coordinate the customer-specific request between OSRAM OS and buyer and/or customer.

Glossary

- 1) **Brightness:** Brightness values are measured during a current pulse of typically 10 ms, with a tolerance of +/- 7%.
- 2) **Reverse Operation:** Not designed for reverse operation. Continuous reverse operation can cause migration and damage of the device.
- 3) **Forward Voltage:** The Forward voltage is measured during a current pulse duration of typically 1 ms with a tolerance of $\pm 0.05V$.
- 4) **Color reproduction index:** Color reproduction index values (CRI-RA) are measured during a current pulse of typically 10 ms and with a tolerance of ± 2 .
- 5) **Chromaticity coordinate groups:** Chromaticity coordinates are measured during a current pulse of typically 25 ms, with an internal reproducibility of ± 0.005 and an expanded uncertainty of ± 0.01 (acc. to GUM with a coverage factor of $k = 3$).
- 6) **Typical Values:** Due to the special conditions of the manufacturing processes of semiconductor devices, the typical data or calculated correlations of technical parameters can only reflect statistical figures. These do not necessarily correspond to the actual parameters of each single product, which could differ from the typical data and calculated correlations or the typical characteristic line. If requested, e.g. because of technical improvements, these typ. data will be changed without any further notice.
- 7) **Characteristic curve:** In the range where the line of the graph is broken, you must expect higher differences between single devices within one packing unit.
- 8) **Tolerance of Measure:** Unless otherwise noted in drawing, tolerances are specified with ± 0.1 and dimensions are specified in mm.
- 9) **Tape and Reel:** All dimensions and tolerances are specified acc. IEC 60286-3 and specified in mm.

Revision History

Version	Date	Change
1.6	2019-01-18	Maximum Ratings Electro - Optical Characteristics (Diagrams) Derating (Diagrams)
1.7	2019-03-22	Electro - Optical Characteristics (Diagrams)
1.8	2019-05-03	Ordering Information Disclaimer
1.9	2019-10-14	Ordering Information Dimensions of Transportation Box Schematic Transportation Box
1.10	2021-06-21	Features Electro - Optical Characteristics (Diagrams)

Published by OSRAM Opto Semiconductors GmbH EU RoHS and China RoHS compliant product
Leibnizstraße 4, D-93055 Regensburg
www.osram-os.com © All Rights Reserved.



此产品符合欧盟 RoHS 指令的要求；
按照中国的相关法规和标准，不含有毒有害物质或元素。