



Buchanan | Buchanan 6 Series

TE Internal #: 9-1437652-6

Tri-Barrier, Printed Circuit Pin, Wire-to-Board, 6 Position, 9.53 mm [.375 in] Centerline, 1 Row, Buchanan 6 Series, Barrier Strips

[View on TE.com >](#)

Connectors > Terminal Blocks & Strips > Barrier Strips

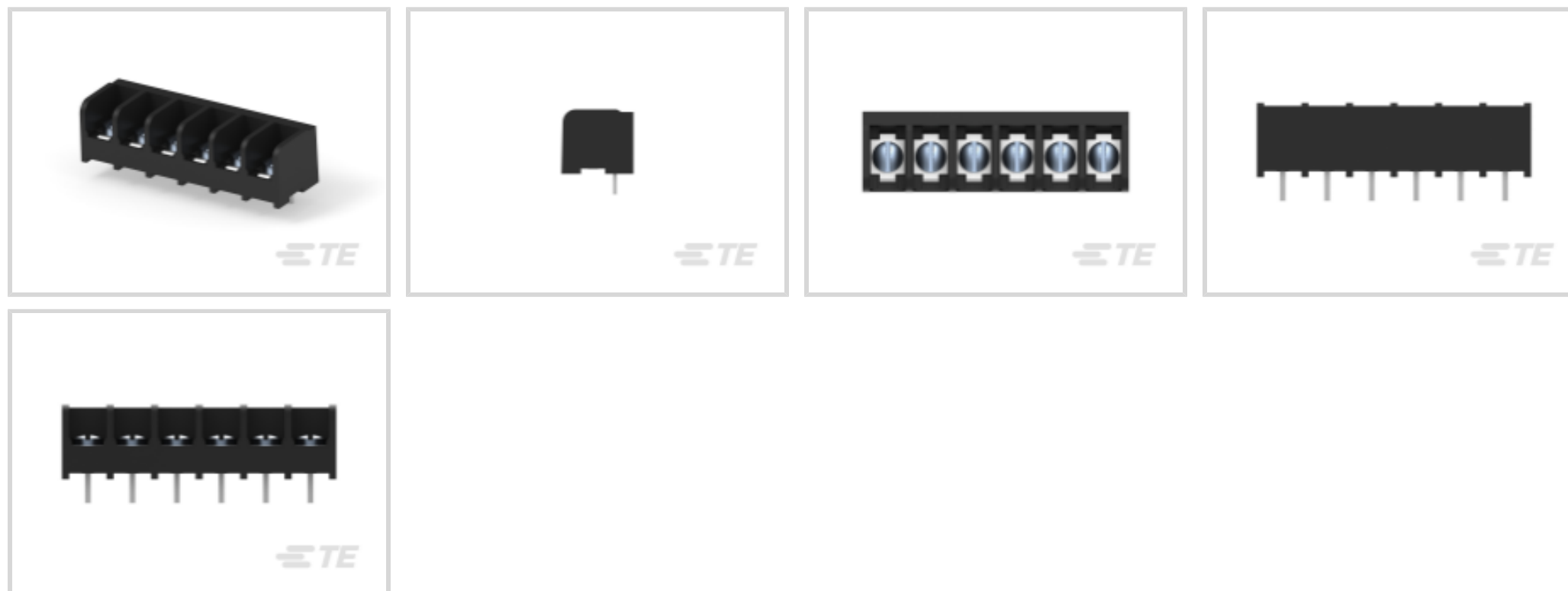

Barrier Strip Style: **Tri-Barrier**

Bottom Termination Type: **Printed Circuit Pin**

Connector System: **Wire-to-Board**

Number of Positions: **6**

Centerline (Pitch): **9.53 mm [.375 in]**

Features

Product Type Features

Block Style	Flat Bottom with standoffs
Connector System	Wire-to-Board
Connector & Contact Terminates To	Printed Circuit Board

Configuration Features

Number of Levels	1
Number of Positions	6
Number of Rows	1

Electrical Characteristics

Operating Voltage	300 V, 600 V
-------------------	--------------

Body Features

Primary Product Color	Black
Product Orientation	Vertical
Barrier Strip Style	Tri-Barrier

Contact Features



PCB Contact Termination Area Plating Material	Tin
Contact Base Material	Copper Alloy
Contact Current Rating (Max)	5 A, 25 A

Termination Features

Bottom Termination Type	Printed Circuit Pin
-------------------------	---------------------

Mechanical Attachment

Screw Head Type	Combo Phil-Slot
Screw Plating Material	Zinc Chromate
Screw Material	Steel
Top Termination Type	Binding Combo Head
Mounting Options	None
Thread Size	6-32
Connector Mounting Type	Board Mount

Housing Features

Housing Material	Thermoplastic
Centerline (Pitch)	9.53 mm [.375 in]

Dimensions

Product Length	58.7 mm [2.311 in]
Wire Size	.3 – 3 mm ²

Operation/Application

Circuit Application	Power
---------------------	-------

Industry Standards

UL Flammability Rating	UL 94V-0
------------------------	----------

Packaging Features

Packaging Quantity	180
--------------------	-----

Product Compliance

[For compliance documentation, visit the product page on TE.com>](#)

EU RoHS Directive 2011/65/EU	Compliant
EU ELV Directive 2000/53/EC	Compliant
China RoHS 2 Directive MIIT Order No 32, 2016	No Restricted Materials Above Threshold
EU REACH Regulation (EC) No. 1907/2006	



Current ECHA Candidate List: JUNE 2024 (241)
 Candidate List Declared Against: JUL 2021 (219)
 Does not contain REACH SVHC

Halogen Content
 BFR/CFR/PVC Free, but Br/Cl >900 ppm in other sources.

Solder Process Capability
 Wave solder capable to 265°C

Product Compliance Disclaimer

This information is provided based on reasonable inquiry of our suppliers and represents our current actual knowledge based on the information they provided. This information is subject to change. The part numbers that TE has identified as EU RoHS compliant have a maximum concentration of 0.1% by weight in homogenous materials for lead, hexavalent chromium, mercury, PBB, PBDE, DBP, BBP, DEHP, DIBP, and 0.01% for cadmium, or qualify for an exemption to these limits as defined in the Annexes of Directive 2011/65/EU (RoHS2). Finished electrical and electronic equipment products will be CE marked as required by Directive 2011/65/EU. Components may not be CE marked. Additionally, the part numbers that TE has identified as EU ELV compliant have a maximum concentration of 0.1% by weight in homogenous materials for lead, hexavalent chromium, and mercury, and 0.01% for cadmium, or qualify for an exemption to these limits as defined in the Annexes of Directive 2000/53/EC (ELV). Regarding the REACH Regulation, the information TE provides on SVHC in articles for this part number is based on the latest European Chemicals Agency (ECHA) 'Guidance on requirements for substances in articles' posted at this URL: <https://echa.europa.eu/guidance-documents/guidance-on-reach>

Also in the Series | **Buchanan 6 Series**

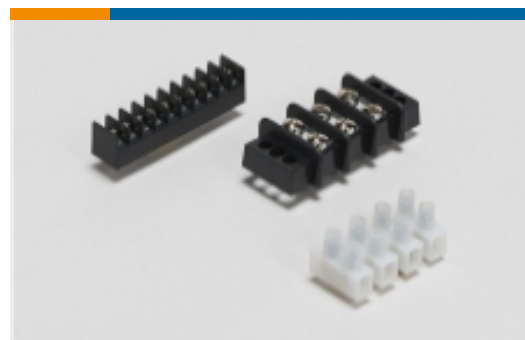

Barrier Strips(258)

Customers Also Bought



TE Part #3-1393210-3
 T9ASSD12-12

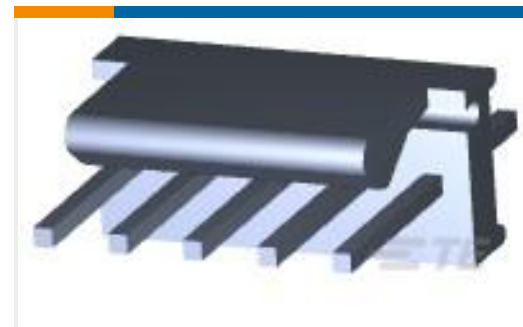

TE Part #640456-5
 05P MTA100 HDR ASSY F/L SQ STR

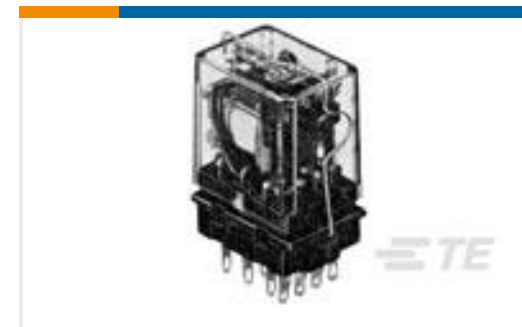

TE Part #3-1393159-9
 20C254=SPRING,HOLD-DOWN,KUP,.0



TE Part #1734366-1
 Std USB Type A, VT, T/H

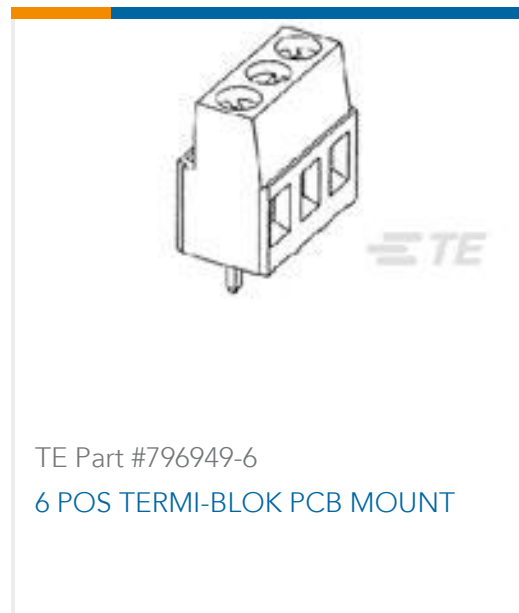
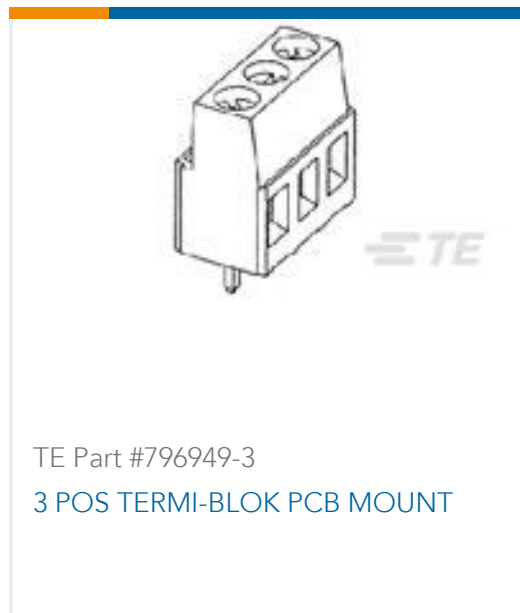
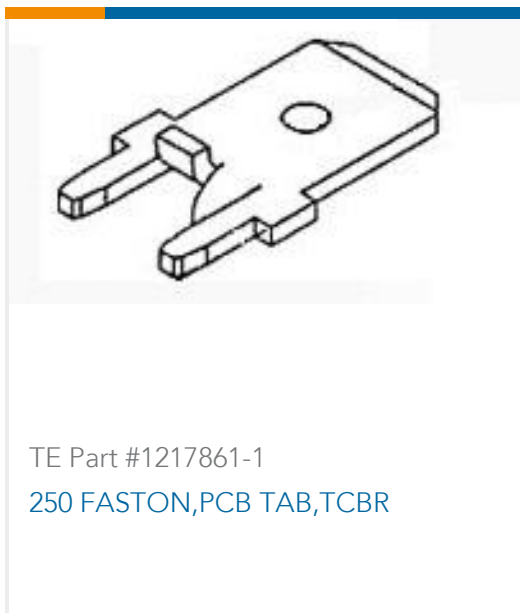

Documents

Product Drawings

[6PCV-06-007=6PCV ASSY](#)

English

CAD Files

[3D PDF](#)

3D

Customer View Model

[ENG_CVM_CVM_9-1437652-6_P.2d_dxf.zip](#)

English

Customer View Model

[ENG_CVM_CVM_9-1437652-6_P.3d_igs.zip](#)

English

Customer View Model

[ENG_CVM_CVM_9-1437652-6_P.3d_stp.zip](#)

English

By downloading the CAD file I accept and agree to the [Terms and Conditions](#) of use.

Datasheets & Catalog Pages

[BUCHANAN TERMINAL BLOCKS CATALOG - BARRIER STRIPS](#)

English

Agency Approvals

[UL](#)

English