

M51955A,B/M51956A,B

VOLTAGE DETECTING, SYSTEM RESETTING IC SERIES

DESCRIPTION

M51955A,B/M51956A,B are semiconductor integrated circuits ideal for detecting input voltage and resetting all types of logic circuits such as CPUs.

They include a built-in delay circuit to provide a retardation time (200 μ sec typ.).

They find extensive applications, including circuits for battery checking, level detecting and waveform shaping.

FEATURES

- Few external parts
- Low threshold operating voltage (Supply voltage to keep low-state at low supply voltage) 0.6V (TYP.) at $R_L = 22k\Omega$
- Wide supply voltage range. 2 ~ 17V
- Sudden change in power supply has minimal effect on the ICs
- Wide operation range of detecting input pin . . . Narrower ranges of $-0.3V \sim V_{CC}$ or $-0.3V \sim 7V$ (Input voltage detecting type) (M51955B, M51956B)
- Suitable for high supply voltage circuit with simple circuit structure (M51955B, M51956B)
- Permits easy configuration of circuit for protection against reverse connection or surges. (M51955B, M51956B)
- Wide application range
- SIL package of the same height as DIP (5-pin SIP)

APPLICATION

Reset circuit of Pch, Nch, CMOS, microcomputer, CPU and microcomputer, Reset of logic circuit, Battery check circuit, Switching circuit back-up voltage, Level detecting circuit, Waveform shaping circuit, Delay waveform generating circuit, DC-DC converter, Over voltage protection circuit.

RECOMMENDED OPERATING CONDITION

Supply voltage range 2 ~ 17V

PIN CONFIGURATION (TOP VIEW)

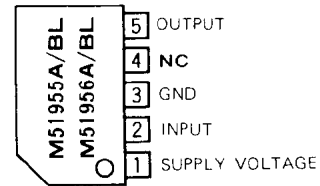

Outline 5P5T

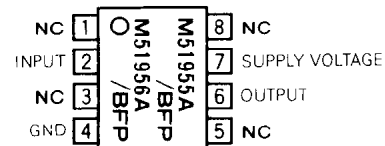

Outline 8P2S-A

NC: NO CONNECTION

BLOCK DIAGRAM

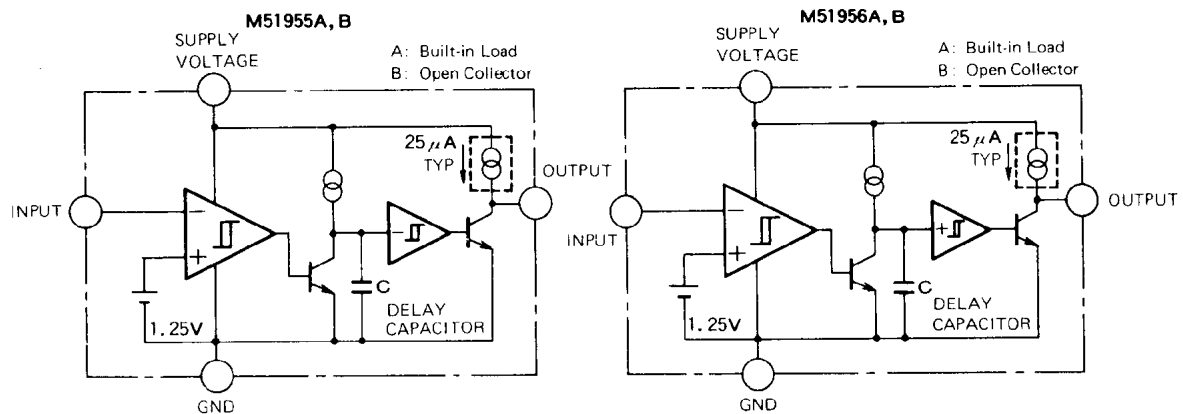

VOLTAGE DETECTING, SYSTEM RESETTNG IC SERIES

FUNCTION DIAGRAM

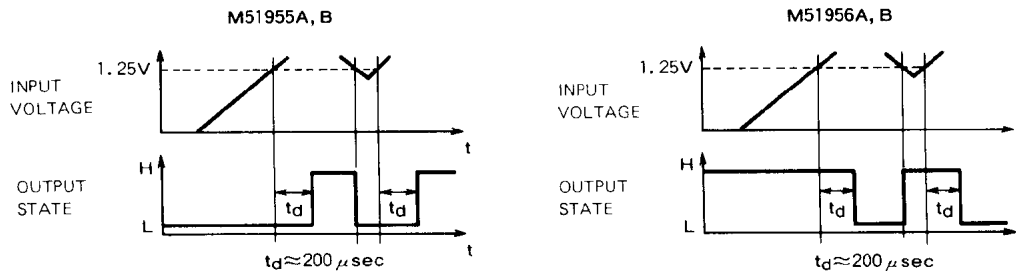

ABSOLUTE MAXIMUM RATINGS (Ta = 25°C, unless otherwise noted)

Symbol	Parameter	Conditions	Ratings	Unit	
V _{CC}	Supply voltage		18	V	
I _{sink}	Output Sink Current		6	mA	
V _O	Output voltage	A Type (Output with constant current load)	V _{CC}	V	
		B Type (Open collector output)	18		
P _d	Power dissipation	5P SIL	450	mW	
		8P FLAT	300		
K _θ	Thermal Derating	Ta = 25°C	5P SIL 8P FLAT	4.5 3	mW/°C
T _{opr}	Operating temperature		-30 ~ +85	°C	
T _{stg}	Storage temperature		-40 ~ +125	°C	

ELECTRICAL CHARACTERISTICS (Ta = 25°C, unless otherwise noted)

"L" reset type	"H" reset type
M51955A	M51956A
M51955B	M51956B

Symbol	Parameter	Test conditions	Limits			Unit
			Min	Typ	Max	
V _S	Detecting voltage		1.20	1.25	1.30	V
ΔV _S	Hysteresis voltage	V _{CC} = 5V	9	15	23	mV
V _S /ΔT	Detecting Voltage Temperature Coefficient		—	0.01	—	%/°C
V _{CC}	Supply Voltage Range	Ta = -30 ~ +85°C	2	—	17	V
V _{IN}	Input voltage Range	Ta = -30 ~ +85°C, V _{CC} ≤ 7V	-0.3	—	V _{CC}	V
		Ta = -30 ~ +85°C, V _{CC} > 7V	-0.3	—	7	
I _{IN}	Input Current	V _{IN} = 1.25V	—	100	500	nA
I _{CC}	Circuit Current	Type A V _{CC} = 5V	—	390	590	μA
		Type B V _{CC} = 5V	—	360	540	
t _{pd}	Delay Time	Ta = -30 ~ +85°C	80	200	500	μs
V _{sat}	Output Saturation Voltage	L reset type V _{CC} = 5V, V _{IN} < 1.2V, I _{sink} = 4mA	—	0.2	0.4	V
		H reset type V _{CC} = 5V, V _{IN} > 1.35V, I _{sink} = 4mA	—	0.2	0.4	
V _{OPL}	Threshold Operating Voltage	R _L = 2.2kΩ, V _{sat} ≤ 0.4V	—	0.67	0.8	V
		R _L = 100kΩ, V _{sat} ≤ 0.4V	—	0.55	0.7	
I _{OH}	Output Leakage Current	Type B	—	—	30	nA
		Type B, Ta = -30 ~ +85°C	—	—	1	μA
I _{OC}	Output Load Current	Type A V _{CC} = 5V, V _O = 1/2 V _{CC}	-40	-25	-17	μA
V _{OH}	Output High Voltage	Type A	V _{CC} - 0.2	V _{CC} - 0.06	—	V

Note: Delay time can be changed by changing delay capacitor for external delay capacitor types.
(Please refer to typical characteristics.)

VOLTAGE DETECTING, SYSTEM RESETTIC IC SERIES

TYPICAL CHARACTERISTICS

**TYPICAL CHARACTERISTICS
 THERMAL DERATING
 (MAXIMUM RATING)**

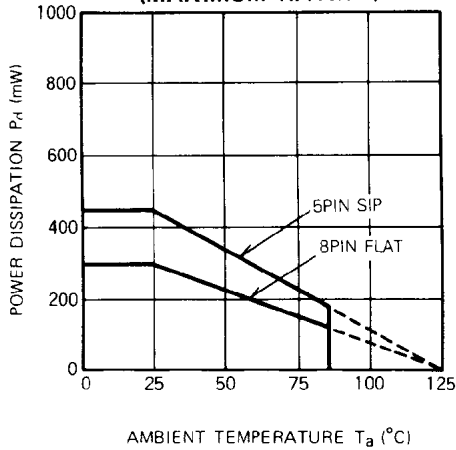

**DETECTING VOLTAGE VS.
 AMBIENT TEMPERATURE
 (Input voltage detecting series)**

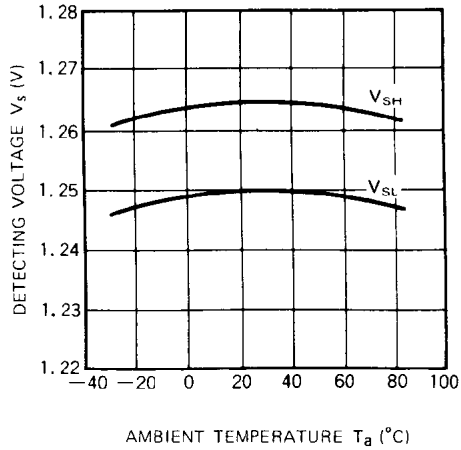

**DETECTION VOLTAGE VS.
 SUPPLY VOLTAGE
 (Input voltage detection series)**

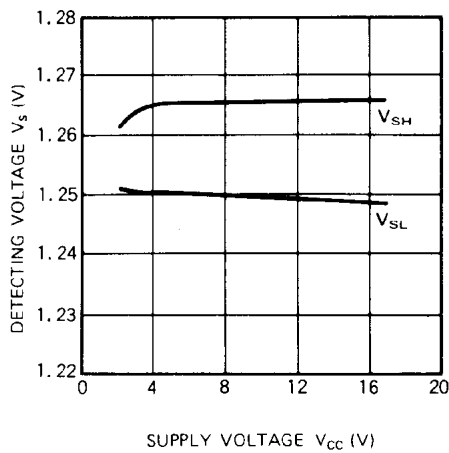

**INPUT CURRENT VS.
 SUPPLY VOLTAGE
 (Input voltage detecting series)**

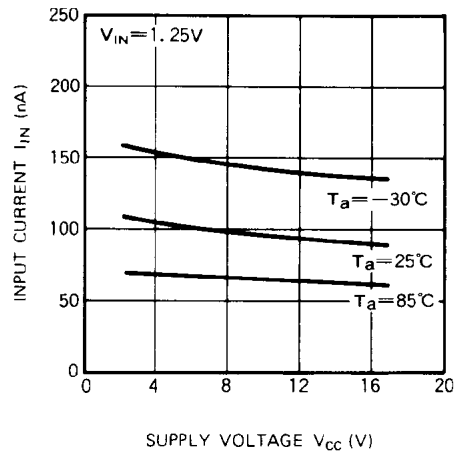

**DELAY TIME VS.
 AMBIENT TEMPERATURE
 (M5195XX, Built-in capacitor type)**

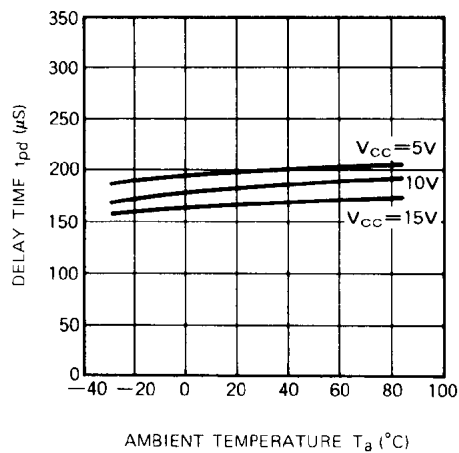

**THRESHOLD OPERATING VOLTAGE
 ([L] reset type)**

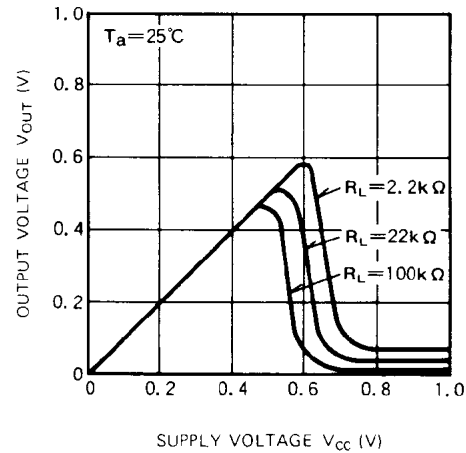

VOLTAGE DETECTING, SYSTEM RESETTNG IC SERIES

**OUTPUT SATURATION VOLTAGE VS.
 OUTPUT SINK CURRENT**

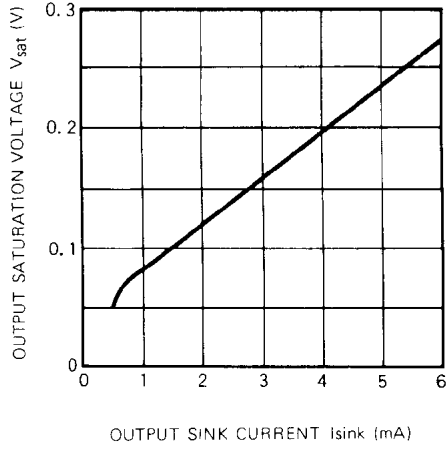

**OUTPUT LOAD CURRENT VS.
 OUTPUT VOLTAGE
 (M519XXA)**

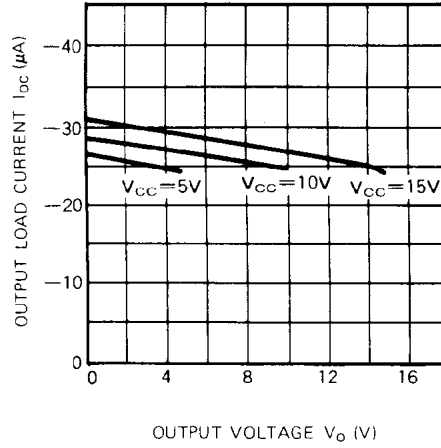

**CIRCUIT CURRENT VS.
 SUPPLY VOLTAGE
 (M51957B, M51958B)**

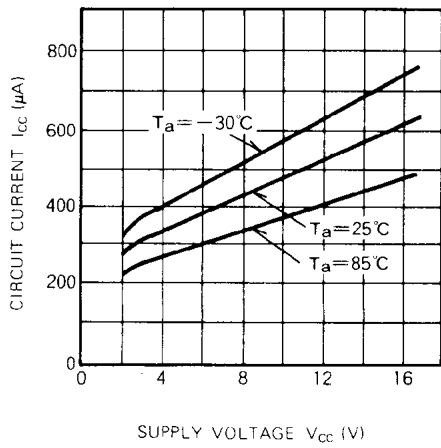

VOLTAGE DETECTING, SYSTEM RESETTING IC SERIES

EXAMPLE OF APPLICATION CIRCUIT
M5195XX Series Reset Circuit

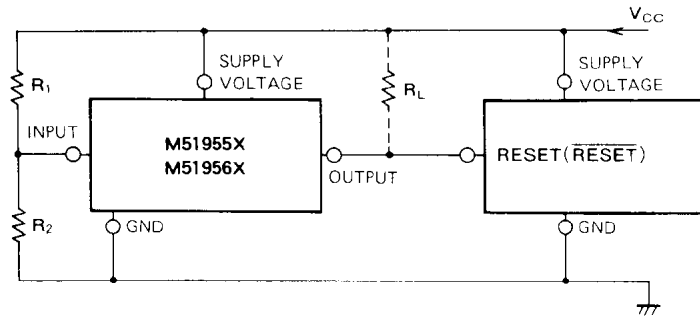

Note 1. When the detecting supply voltage is 4.25V, M51951, M51952, M51953 and M51954 are used. In the case, R_1 and R_2 are not necessary.

When the voltage is anything except 4.25V, M51955, M51956, M51957 and M51958 are used. In this case, the detecting supply voltage is $1.25 \times \frac{R_1 + R_2}{R_2}$ (V) approximately. The detecting supply voltage can be set between 2V and 15V.

Note 2. When the delay time is short, M51951, M51952, M51955 and M51956 are available. These ICs have a delay capacity and the delay time is about 200 μ s. If a longer delay time is necessary, M51953, M51954, M51957 and M51958 are used. In the case, the delay time is about $0.34 \times Cd$ (pF) μ sec.

Note 3. If M5195XX and the logic circuit have a common power supply, type A (built-in load type) can be applied whether a pull-up resistor is included in the logic circuit or not.

Note 4. The logic circuit preferably should not have a pull-down resistor, but if one is present, add load resistor R_L to overcome the pull-down resistor.

Note 5. When the reset terminal in the logic circuit is of the low reset type, M51951, M51953, M51955 and M51957 are used and when the terminal is of the high reset type, M51952, M51954, M51956 and M51958 are used.

Note 6. When a negative supply voltage is used, supply voltage side of M5195XX and the GND side are connected to negative supply voltage respectively.

VOLTAGE DETECTING, SYSTEM RESETTING IC SERIES

Application to High Supply Voltage Circuit

The absolute maximum rating of supply voltage for M51955B, M51956B is 18V. By dividing supply voltage

using resistors, these ICs can be used in high supply voltage circuit.

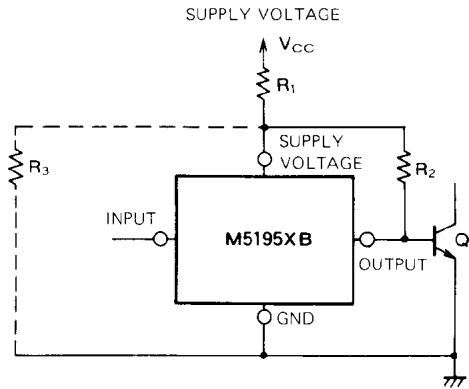

In the above figure, the voltage applied to M5195XB is as follows. The voltage range is set between 2V and 17V.

$$\text{at } Q_1 \text{ ON: } \frac{R_2 \cdot \left[\frac{R_3}{(R_1 + R_3)} \cdot V_{CC} - (R_1 // R_3) \cdot I_{CC} \right] + (R_1 // R_3) \cdot V_{BE1}}{R_2 + (R_1 // R_3)}$$

$$\text{at } Q_1 \text{ OFF: } \frac{R_2 \cdot \left[\frac{R_3}{(R_1 + R_3)} \cdot V_{CC} - (R_1 // R_3) \cdot I_{CC} \right]}{R_2 + (R_1 // R_3)}$$

$$R_1 // R_3 \equiv \frac{R_1 \cdot R_3}{R_1 + R_3}$$

V_{CC} : Circuit current of M5195XB

V_{BE1} : Base-emitter voltage $\approx 0.7V$ (Transistor Q_1)

This circuit provides reverse protection (in case of reverse connection of power supply) and surge protection.

Using the application circuit, the directly rectified or smoothing commercial voltage can be applied as shown below.

