

### AUML Varistor Series



#### Size Table

Metric	EIA
3216	1206
3225	1210
4532	1812
5650	2220

#### Applications

- Suppression of inductive switching or other transient events such as EFT and surge voltage at the circuit board level
- ESD protection for components sensitive to IEC 61000-4-2 (Level 4), MIL-STD-883C, Method 3015.7, and other industry specifications (See Also the MLE or MLN Series)
- Provides on-board transient voltage protection for ICs and transistors
- Used to help achieve electromagnetic compliance of end products
- Replace larger surface mount TVS Zeners in many applications

#### Description

The AUML Series of Multilayer Transient Surge Suppressors was specifically designed to suppress the destructive transient voltages found in an automobile. The most common transient condition results from large inductive energy discharges. The electronic systems in the automobile, e.g. antilock brake systems, direct ignition systems, engine control, airbag control systems, wiper motor controls, etc., are susceptible to damage from these voltage transients and thus require protection. The AUML transient suppressors have temperature independent suppression characteristics affording protection from -40°C to 125°C.

The AUML suppressor is manufactured from semiconducting ceramics which offer rugged protection and excellent transient energy absorption in a small package. The devices are available in ceramic leadless chip form, eliminating lead inductance and assuring fast speed of response to transient surges. These Suppressors require significantly smaller space and land pads than Silicon TVS diodes, offering greater circuit board layout flexibility for the designer.

Also see the Littelfuse ML, MLN and MLE Series of Multilayer Suppressors.

#### Features

- AEC - Q200 compliant
- RoHS Compliant
- Load Dump energy rated per SAE Specification J1113
- Leadless, surface mount chip form
- "Zero" Lead Inductance
- Variety of energy ratings available
- No temperature derating up to 125°C ambient
- High peak surge current capability
- Low Profile, compact industry standard chip size; (1206, 1210, 1812 and 2220 Sizes)
- Inherent bidirectional clamping
- No Plastic or epoxy packaging assures better than 94V-0 flammability rating

#### Absolute Maximum Ratings

- For ratings of individual members of a series, see Device Ratings and Specifications chart.

	Continuous	AUML Series	Units
<b>Steady State Applied Voltage</b>			
DC Voltage Range ( $V_{MDC}$ )		18, 24, 48, 68	V
<b>Transient</b>			
Load Dump Energy, ( $W_{LD}$ )		1.5 to 25	J
Jump Start Capability (5 minutes), ( $V_{JUMP}$ )		48	V
Operating Ambient Temperature Range ( $T_A$ )		-40 to +125	°C
Storage Temperature Range ( $T_{STG}$ )		-40 to +150	°C
Temperature Coefficient ( $\alpha V$ ) of Clamping Voltage ( $V_C$ ) at Specified Test Current		<0.01	%/°C

CAUTION: Stresses above those listed in "Absolute Maximum Ratings" may cause permanent damage to the device. This is a stress only rating and operation of the device at these or any other conditions above those indicated in the operational sections of this specification is not implied.

**Device Ratings and Specifications**

Part Number	Maximum Ratings (125°C)			Specifications (25°C)				
	Maximum Continuous DC Voltage	Jump Start Voltage (5 Min)	Load Dump Energy (10 Pulses)	Nominal Varistor Voltage at 10mA DC Test Current		Maximum Standby Leakage (at 13V DC)	Maximum Clamping Voltage (V <sub>c</sub> ) at Test Current (8/20μs)	
	V <sub>M(DC)</sub> (V)	V <sub>JUMP</sub> (V)	W <sub>LD</sub> (J)	V <sub>N(DC) Min</sub> (V)	V <sub>N(DC) Max</sub> (V)	I <sub>L</sub> (μA)	V <sub>c</sub> (V)	I <sub>p</sub> (A)
V18AUMLA1206	18	24.5	1.5	23	32	50	40	1.5
V18AUMLA1210	18	24.5	3.0	23	32	50	40	1.5
V18AUMLA1812	18	24.5	6.0	23	32	100	40	5.0
V18AUMLA2220	18	24.5	25	23	32	200	40	10.0
V24AUMLA2220	24	24.5	25	32	39	200	60	10.0
V48AUMLA2220	48	24.5	25	54.5	66.5	200	105	10.0
V68AUMLA2220	68	24.5	25	77.2	94.4	200	135	10.0

NOTES: 1. Average power dissipation of transients not to exceed 0.1W, 0.15W, 0.3W and 1W for model sizes 1206, 1210, 1812 and 2220 respectively.  
 2. Load dump :min. time of energy input 40ms, interval 60sec(the load dump time constant Td differs from the time constant of energy input; load dump rating for ISO 7637-2 pulse 5a, please contact littelfuse.  
 3. Thermal shock capability per Mil-Std-750, Method 1051: -55°C to 125°C, 5 minutes at 25°C, 25 Cycles: 15 minutes at each extreme.  
 4. For application specific requirements, please contact Littelfuse.

**Current, Energy and Power Derating Curve**

When transients occur in rapid succession, the average power dissipation is the energy (watt-seconds) per pulse times the number of pulses per second. The power so developed must be within the specifications shown on the Device Ratings and Characteristics Table for the specific device. Certain parameter ratings must be derated at high temperatures as shown below.

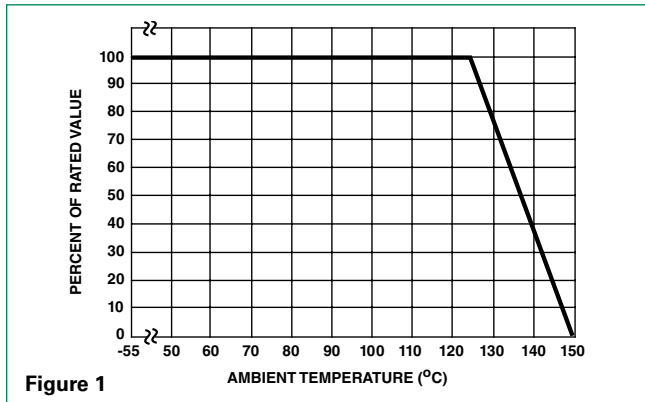

**Peak Pulse Current Test Waveform for Clamping Voltage**

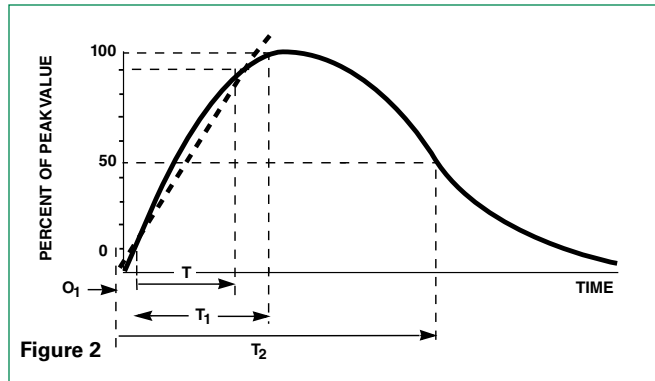

O<sub>1</sub> = Virtual Origin of Wave  
 T = Time from 10% to 90% of Peak  
 T<sub>1</sub> = Rise Time = 1.25 x T  
 T<sub>2</sub> = Decay Time  
**Example** - For an 8/20 μs Current Waveform:  
 8 μs = T<sub>1</sub> = Rise Time  
 20 μs = T<sub>2</sub> = Decay Time

**Maximum Leakage Current/Clamping Voltage Curve for AUML Series at 25°C**

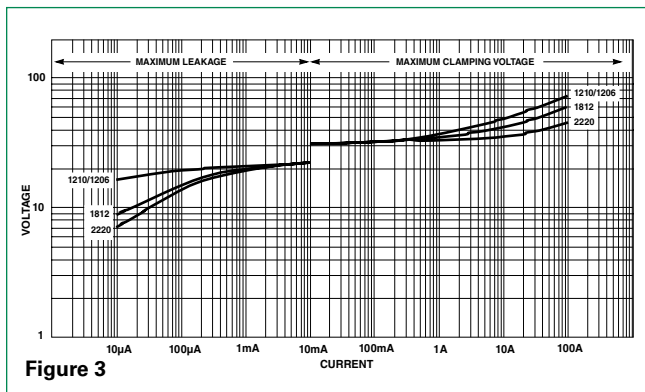

**Typical V-I Characteristics of the V18AUMLA2220 at -40°C, 25°C, 85°C and 125°C**

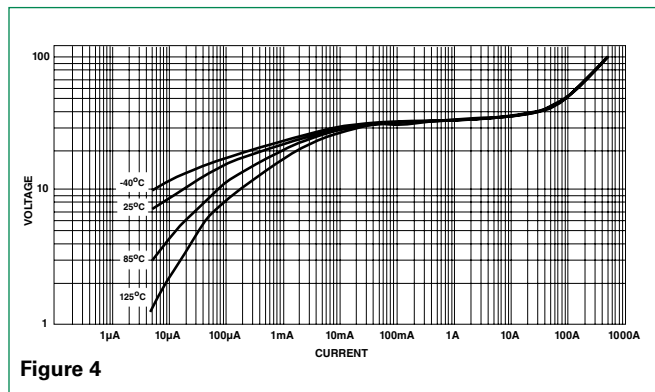

**Temperature Effects**

In the leakage region of the AUML suppressor, the device characteristics approaches a linear (ohmic) relationship and shows a temperature dependent affect. In this region the suppressor is in a high resistance mode (approaching  $10^6\Omega$ ) and appears as a near open-circuit. Leakage currents at maximum rated voltage are in the microamp range.

When clamping transients at higher currents (at and above the 10mA range), the AUML suppressor approaches a 1-10 characteristic. In this region the characteristics of the AUML are virtually temperature independent. Figure 3 shows the typical effect of temperature on the V-I characteristics of the AUML suppressor.

**Load Dump Energy Capability**

A Load Dump transient occurs when the alternator load in the automobile is abruptly reduced. The worst case scenario of this transient occurs when the battery is disconnected while operating at full rated load. There are a number of different Load Dump specifications in existence in the automotive industry, with the most common one being that recommended by the Society of Automotive Engineers, specification #SAE J1113. Because of the diversity of these Load Dump specifications Littelfuse defines the Load Dump energy capability of the AUML suppressor range as that energy dissipated by the device itself, independent of the test circuit setup. The resultant Load Dump energy handling capability serves as an excellent figure of merit for the AUML suppressor. Standard Load Dump specifications require a device capability of 10 pulses at rated energy, across a temperature range of  $-40^{\circ}\text{C}$  to  $+125^{\circ}\text{C}$ . This capability requirement is well within the ratings of all of the AUML Series (Figure 6 on next page).

The very high energy absorption capability of the AUML suppressor is achieved by means of a highly controlled manufacturing process. This technology ensures that a large volume of suppressor material, with an interdigitated layer construction, is available for energy absorption in an extremely small package. Unlike equivalent rated Silicon TVS diodes, the entire AUML device volume is available to dissipate the Load Dump energy.

Hence, the peak temperatures generated by the Load Dump transient are significantly lower and evenly dissipated throughout the complete device (Figure 5 below). This even energy dissipation ensures that there are lower peak temperatures generated at the P-N grain boundaries of the AUML suppressor.

There are a number of different size devices available in the AUML Series, each one with a load dump energy rating, which is size dependent.

**Speed of Response**

The clamping action of the AUML suppressor depends on a conduction mechanism similar to that of other semiconductor devices (i.e. P-N Junctions). The apparent slow response time often associated with transient voltage suppressors (Zeners, MOVs) is often due to parasitic inductance in the package and leads of the device and less dependent of the basic material (Silicon,  $\text{Z}_\text{N}\text{O}$ ). Thus, the single most critical element affecting the response time of any suppressor is its lead inductance. The AUML suppressor is a surface mount device, with no leads or external packaging, and thus, it has virtually zero inductance. The actual response time of a AUML surge suppressor is in the 1 to 5 ns range, more than sufficient for the transients which are likely to be encountered in an automotive environment.

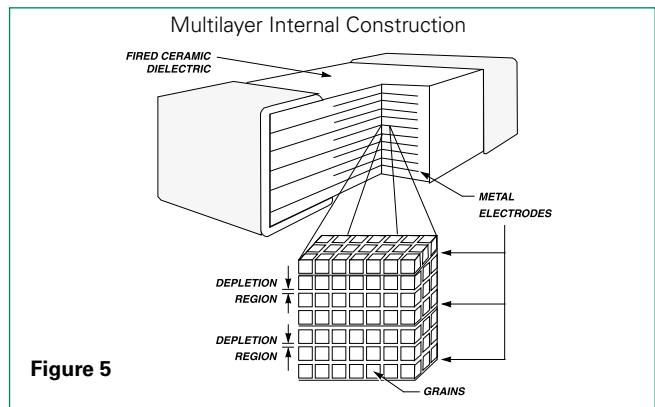

Figure 5

**AUML Load Dump Pulsing over a Temperature Range of  $-55^{\circ}\text{C}$  to  $+125^{\circ}\text{C}$**

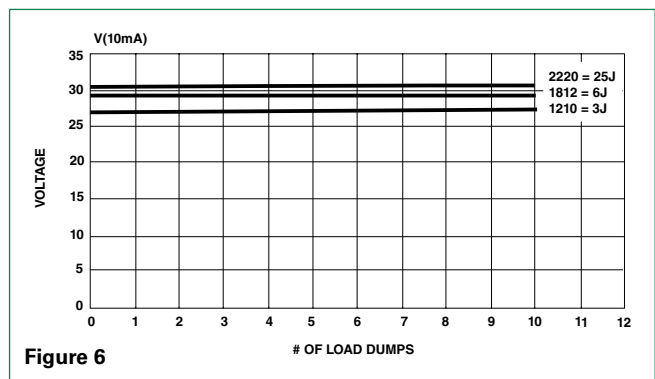

Figure 6

### Explanation of Terms

#### Maximum Continuous DC Working Voltage ( $V_{M*(DC)+}$ )

This is the maximum continuous DC voltage which may be applied, up to the maximum operating temperature (125°C), to the ML suppressor. This voltage is used as the reference test point for leakage current and is always less than the breakdown voltage of the device.

#### Load Dump Energy Rating $W_{LD+}$

This is the actual energy the part is rated to dissipate under Load Dump conditions (not to be confused with the "source energy" of a Load Dump test specification).

#### Maximum Clamping Voltage $V_{C+}$

This is the peak voltage appearing across the suppressor when measured at conditions of specified pulse current and specified waveform (8/20 $\mu$ s). It is important to note that the peak current and peak voltage may not necessarily be coincidental in time.

#### Leakage Current $I_{L+}$

In the nonconducting mode, the device is at a very high impedance (approaching  $10^6\Omega$  at its rated working voltage) and appears as an almost open circuit in the system. The leakage current drawn at this level is very low (<25 $\mu$ A at ambient temperature) and, unlike the Zener diode, the multilayer TVS has the added advantage that, when operated up to its maximum temperature, its leakage current will not increase above 500 $\mu$ A.

#### Nominal Voltage $V_{NDC+}$

This is the voltage at which the AUML enters its conduction state and begins to suppress transients. In the automotive environment this voltage is defined at the 10mA point and has a minimum ( $V_{NDC\ MIN}$ ) and maximum ( $V_{NDC\ MAX}$ ) voltage specified.

### Additional Information



**Datasheet**



**Resources**



**Samples**

**Lead (Pb) Soldering Recommendations**

The principal techniques used for the soldering of components in surface mount technology are IR Re-flow and Wave soldering. Typical profiles are shown on the right.

The termination option available for each solder technique is:

- |                               |                               |
|-------------------------------|-------------------------------|
| Reflow                        | Wave                          |
| 1. Nickel Barrier (preferred) | 1. Nickel Barrier (preferred) |
| 2. Silver/Platinum            |                               |

The recommended solder for the AUML suppressor is a 62/36/2 (Sn/Pb/Ag), 60/40 (Sn/Pb) or 63/37 (Sn/Pb). Littelfuse also recommends an RMA solder flux.

Wave soldering is the most strenuous of the processes. To avoid the possibility of generating stresses due to thermal shock, a preheat stage in the soldering process is recommended, and the peak temperature of the solder process should be rigidly controlled.

When using a reflow process, care should be taken to ensure that the AUML chip is not subjected to a thermal gradient steeper than 4 degrees per second; the ideal gradient being 2 degrees per second. During the soldering process, preheating to within 100 degrees of the solder's peak temperature is essential to minimize thermal shock.

Once the soldering process has been completed, it is still necessary to ensure that any further thermal shocks are avoided. One possible cause of thermal shock is hot printed circuit boards being removed from the solder process and subjected to cleaning solvents at room temperature. The boards must be allowed to cool gradually to less than 50°C before cleaning.

**Reflow Solder Profile**

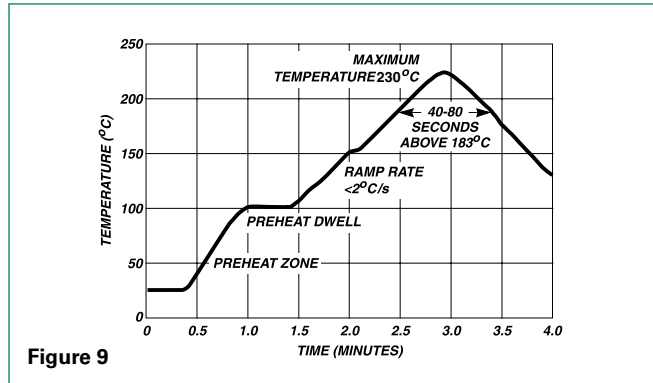

Figure 9

**Wave Solder Profile**

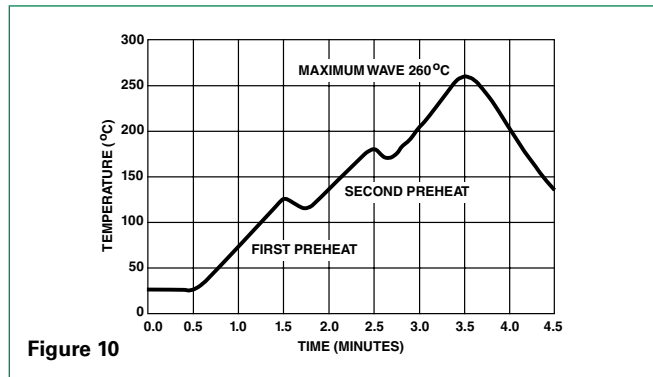

Figure 10

**Lead-free (Pb-free) Soldering Recommendations**

Littelfuse offers the Nickel Barrier Termination finish for the optimum Lead-free solder performance.

The preferred solder is 96.5/3.0/0.5 (SnAgCu) with an RMA flux, but there is a wide selection of pastes and fluxes available with which the Nickel Barrier parts should be compatible.

The reflow profile must be constrained by the maximums in the Lead-free Reflow Profile. For Lead-free Wave soldering, the Wave Solder Profile still applies.

Note: the Lead-free paste, flux and profile were used for evaluation purposes by Littelfuse, based upon industry standards and practices. There are multiple choices of all three available, it is advised that the customer explores the optimum combination for their process as processes vary considerably from site to site.

**Lead-free Re-flow Solder Profile**

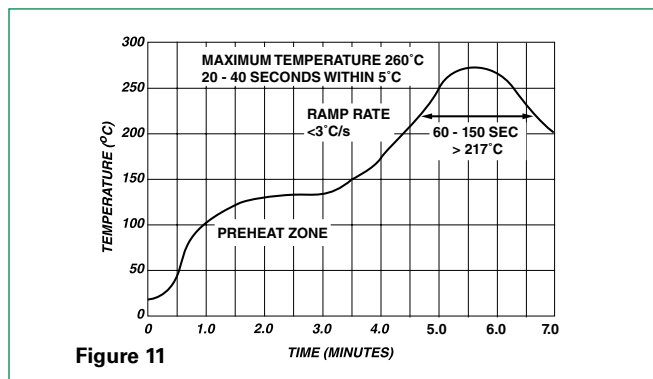
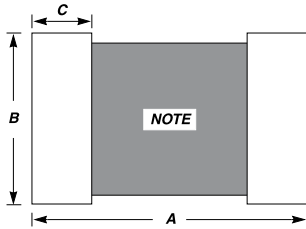

Figure 11

### Product Dimensions (mm)

PAD LAYOUT DIMENSIONS



Note: Avoid metal runs in this area, parts are not recommended for use in applications using Silver (Ag) epoxy paste.

CHIP LAYOUT DIMENSIONS

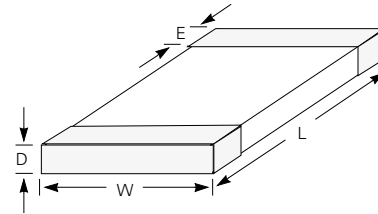

SYMBOL	1206 Size		1210 Size		1812 Size		2220 Size	
	IN	MM	IN	MM	IN	MM	IN	MM
A	0.203	5.150	0.219	5.510	0.272	6.910	0.315	8.000
B	0.103	2.620	0.147	3.730	0.172	4.360	0.240	6.190
C	0.065	1.650	0.073	1.850	0.073	1.850	0.073	1.850
D (max.)	0.071	1.80	0.070	1.80	0.07	1.80	0.118	3.00
E	0.020 +/- 0.010	0.50 +/- 0.25	0.020 +/- 0.010	0.50 +/- 0.25	0.020 +/- 0.010	0.50 +/- 0.25	0.030 +/- 0.010	0.75 +/- 0.25
L	0.125 +/- 0.012	3.20 +/- 0.03	0.125 +/- 0.012	3.20 +/- 0.30	0.180 +/- 0.014	4.50 +/- 0.35	0.225 +/- 0.016	5.70 +/- 0.40
W	0.060 +/- 0.011	1.60 +/- 0.28	0.100 +/- 0.012	2.54 +/- 0.30	0.125 +/- 0.012	3.20 +/- 0.30	0.197 +/- 0.016	5.00 +/- 0.40

### Part Numbering System

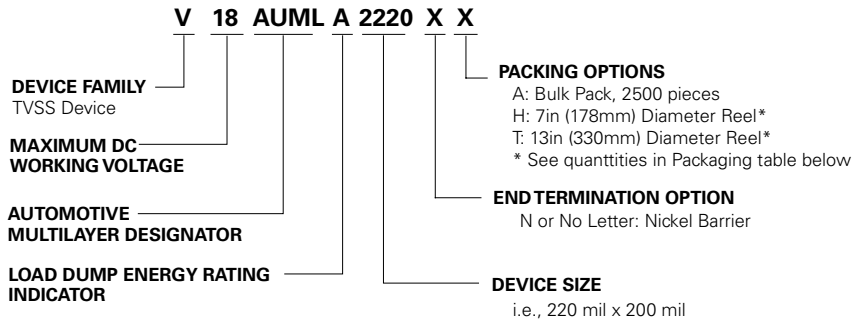

### Packaging\*

Device Size	Quantity		
	13" Inch Reel ('T' Option)	7" Inch Reel ('H' Option)	Bulk Pack ('A' Option)
1206	10,000	2,500	2,500
1210	8,000	2,000	2,000
1812	4,000	1,000	1,000
2220	4,000	1,000	1,000

\*(Packaging) It is recommended that parts be kept in the sealed bag provided and that parts be used as soon as possible when removed from bags.

### Tape and Reel Specifications

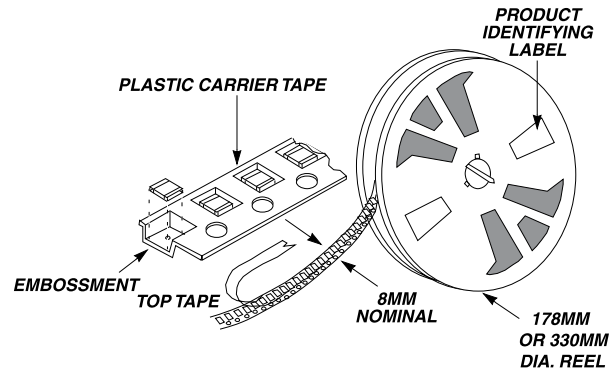
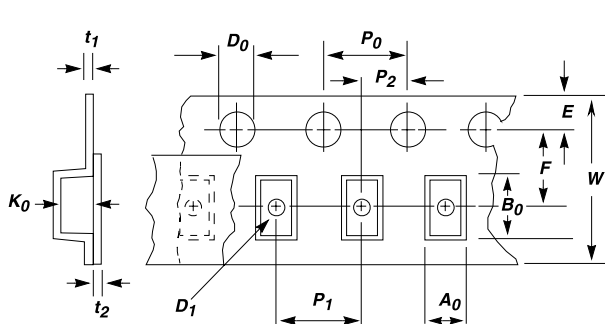

Symbol	Description	Dimensions in Millimeters	
$A_0$	Width of Cavity	Dependent on Chip Size to Minimize Rotation.	
$B_0$	Length of Cavity	Dependent on Chip Size to Minimize Rotation.	
$K_0$	Depth of Cavity	Dependent on Chip Size to Minimize Rotation.	
$W$	Width of Tape	8 $\pm$ 0.2	12 $\pm$ 0.2
$F$	Distance Between Drive Hole Centers and Cavity Centers	3.5 $\pm$ 0.5	5.4 $\pm$ 0.5
$E$	Distance Between Drive Hole Centers and Tape Edge	1.75 $\pm$ 0.1	1.75 $\pm$ 0.1
$P_1$	Distance Between Cavity Center	4 $\pm$ 0.1	8 $\pm$ 0.1
$P_2$	Axial Distance Between Drive Hole Centers and Cavity Centers	2 $\pm$ 0.1	2 $\pm$ 0.1
$P_0$	Axial Distance Between Drive Hole Centers	8 $\pm$ 0.1	8 $\pm$ 0.1
$D_0$	Drive Hole Diameter	1.55 $\pm$ 0.05	1.55 $\pm$ 0.05
$D_1$	Diameter of Cavity Piercing	1.05 $\pm$ 0.05	1.55 $\pm$ 0.05
$T_1$	Embossed Tape Thickness	0.3 Max	0.4 Max
$T_2$	Top Tape Thickness	0.1 Max	0.1 Max

NOTE: Dimensions in millimeters.

- Conforms to EIA-481-1, Revision A
- Can be supplied to IEC publication 286-3

Tape	8mm Wide Tape		12mm Wide Tape	
Chip Size	1206	1210	1812	2220

### Standard Packaging

Tape and reel is the standard packaging method of the AUML Series. The standard 300 millimeter (13-inch) reel utilized contains 4000 pieces for the 2200 and 1812 chips, 8000 pieces for the 1210 chip and 10,000 pieces for the 1206 size.

To order: add 'T' to the standard part number, e.g. V18AUMLA2220T.

### Special Packaging

**Option 1:** 178 millimeter (7-inch) reels containing 1000 (2220, 1812), 2000 (1210), 2500 (1206), pieces are available. To order add 'H' to the standard part number, e.g. V18AUMLA2220H.

**Option 2** For small sample quantities (less than 100 pieces) the units are shipped bulk pack. To order add 'A' to the standard part number, e.g. V18AUMLA2220A.

**Disclaimer Notice** - Information furnished is believed to be accurate and reliable. However, users should independently evaluate the suitability of and test each product selected for their own applications. Littelfuse products are not designed for, and may not be used in, all applications. Read complete Disclaimer Notice at [www.littelfuse.com/disclaimer-electronics](http://www.littelfuse.com/disclaimer-electronics).

# Mouser Electronics

Authorized Distributor

Click to View Pricing, Inventory, Delivery & Lifecycle Information:

[Littelfuse:](#)

[V18AUMLA1206NT](#) [V18AUMLA1210A](#) [V18AUMLA1210H](#) [V18AUMLA2220H](#) [V18AUMLA1206A](#) [V18AUMLA2220T](#)  
[V18AUMLA1206H](#) [V18AUMLA1812A](#) [V18AUMLA2220A](#) [V18AUMLA1206NH](#) [V18AUMLA1812H](#)  
[V18AUMLA1206NA](#) [V18AUMLA1210NT](#) [V18AUMLA1210T](#) [V18AUMLA1210NH](#) [V48AUMLA2220H](#)  
[V24AUMLA2220H](#) [V18AUMLA1210NA](#) [V16AUMLA2220NS](#) [V18AUMLA1812NH](#) [V18AUMLA1812NA](#)