

36V High Efficiency Boost Converter with I2C Controlled 6-CH LED Driver

General Description

The RT4539 is a high efficiency driver for white LEDs. It is suitable for single/two cell battery input to drive LED light bars which contains six strings in parallel. The internal current sinks support a maximum of $\pm 2\%$ current mismatching for excellent brightness uniformity in each string of LEDs. To provide enough headroom for current sink operation, the Boost converter monitors the minimum voltage of the feedback pins and regulates an optimized output voltage for power efficiency.

The RT4539 has a wide input voltage operating range from 2.7V to 24V and contains I²C interface for controlling the dimming mode, operating frequency and the LED current. The internal 250m Ω , 36V power switch with current-mode control provides over-current protection. The switching frequency of the RT4539 is adjustable from 300kHz to 1.6MHz, which allows flexibility between efficiency and component size.

The RT4539 is available in the WL-CSP-20B 1.71x2.371 (BSC), with pitch 0.4mm package.

Applications

- Tablet and Notebook Backlight

Features

- **Wide Operating Input Voltage : 2.7V to 24V**
- **High Output Voltage : Up to 36V**
- **Programmable Channel Current : 10.04mA to 35mA**
- **Channel Current Regulation with Accuracy $\pm 3\%$ and Matching $\pm 2\%$**
- **Dimming Controls**
 - ▶ **Direct PWM Dimming up to 20kHz and Minimum On-Time to 400ns**
 - ▶ **PWM to Analog Dimming up to 20kHz with 9-bit Resolution**
 - ▶ **PWM Pin and/or I2C-Controlled with Programmable Linear @12 bits or Exponential @11 bits Brightness Control**
 - ▶ **Digitally Advanced Sloping for Smooth Dimming**
- **Adjustable Dimming Mode Control.**
- **Adjustable Advanced Brightness Control.**
- **Adjustable Switching Frequency of Boost Converter from 300kHz to 1.6MHz.**
- **PFM function for High Efficiency at Light Load**
- **Programmable Spread Spectrum Scheme and Edge Rate Control Minimize Switching Noise and Improve EMI Performance**
- **Protections**
 - ▶ **LED Strings Open Detection**
 - ▶ **LED Strings Short Protection**
 - ▶ **Programmable Current Limit of Boost.**
 - ▶ **Programmable Over-Voltage Protection Level**
 - ▶ **Over-Temperature Protection**
- **Integrated Memory by MTP**
- **20-Ball WL-CSP, with pitch 0.4mm Package**

Simplified Application Circuit

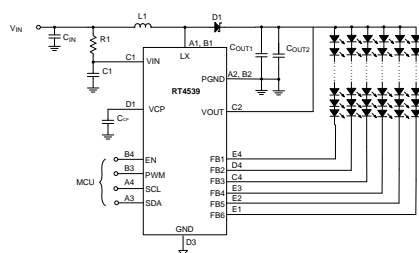

Ordering Information

RT4539 □

Package Type
WSC : WL-CSP-20B 1.71x2.371 (BSC)

Note :

Richtek products are :

- ▶ RoHS compliant and compatible with the current requirements of IPC/JEDEC J-STD-020.
- ▶ Suitable for use in SnPb or Pb-free soldering processes.

Marking Information

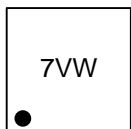

7V : Product Code
W : Date Code

Pin Configuration

(TOP VIEW)

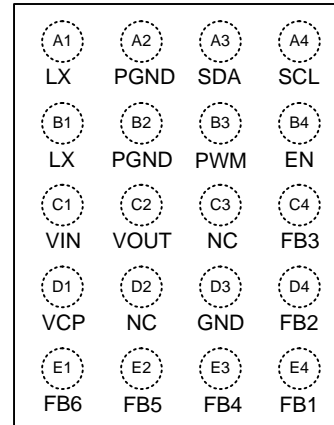

WL-CSP-20B 1.71x2.371 (BSC)

Functional Pin Description

Pin No.	Pin Name	Pin Function
A1, B1	LX	Switch node of boost converter.
A2, B2	PGND	Power ground.
A3	SDA	Data signal input of I ² C interface.
A4	SCL	Clock signal input of I ² C interface.
B3	PWM	PWM dimming control input.
B4	EN	Enable control input (Active High).
C1	VIN	Device power supply input.
C2	VOUT	Output of boost converter.
C3, D2	NC	Not connected.
C4	FB3	Current sink for LED3.
D1	VCP	Internal LDO output pin. Connect a capacitor (Ccp) between this pin and the ground reference.
D3	GND	Ground.
D4	FB2	Current sink for LED2.
E1	FB6	Current sink for LED6.
E2	FB5	Current sink for LED5.
E3	FB4	Current sink for LED4.
E4	FB1	Current sink for LED1.

Functional Block Diagram

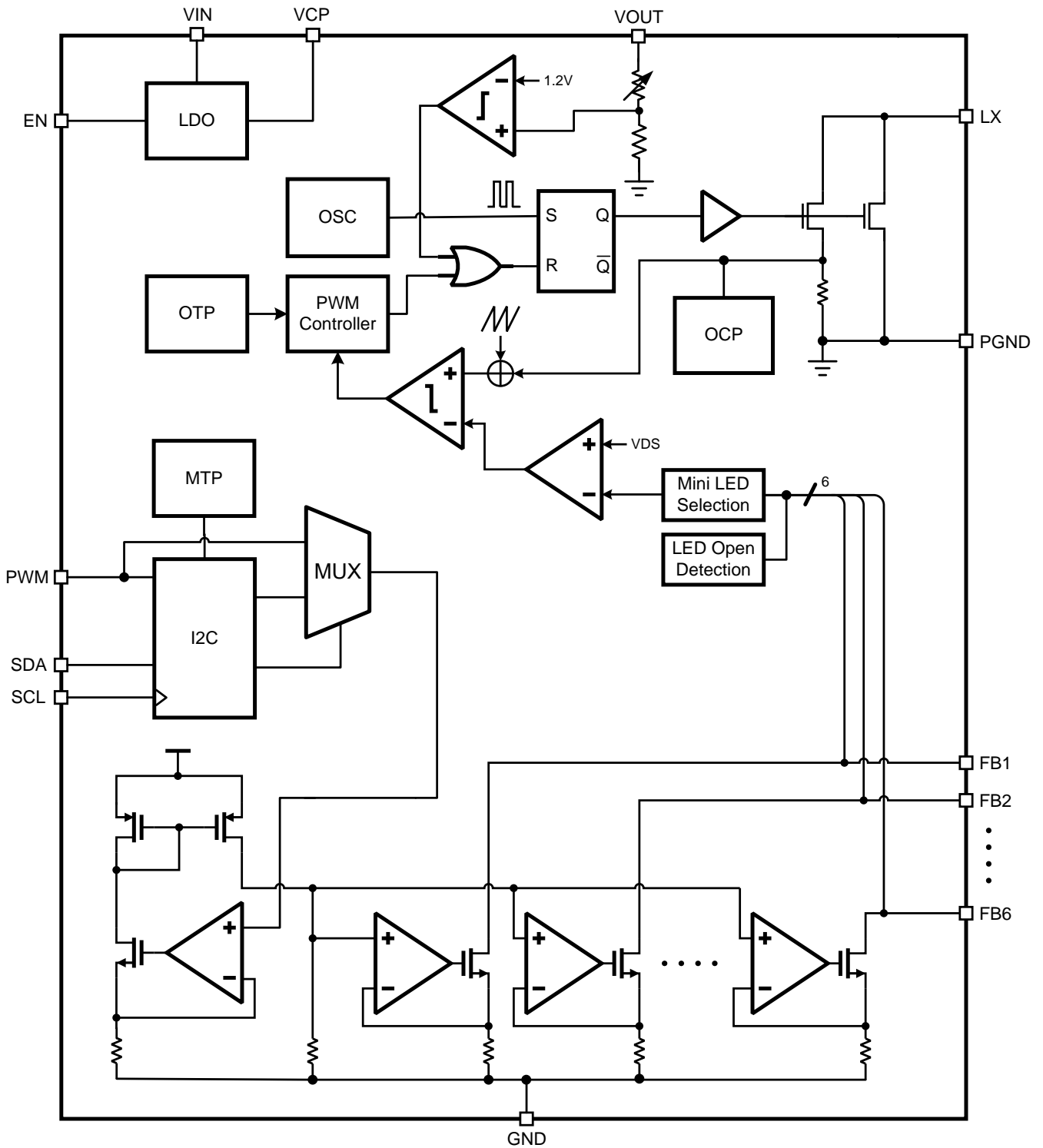

Operation

Enable Control

When VIN is higher than the UVLO voltage and the EN pin input voltage is higher than rising threshold, the VCP will be regulated around 3.4V if VIN is higher than 3.4V.

Switching Frequency

The boost converter switching frequency is adjusted by the I²C interface. The switching frequency range is from 300kHz to 1.6MHz.

PWM Controller

This controller can control LX N-MOSFET on/off according to error amplifier signal. This block controls the minimum on-time and max duty of LX. The RT4539 PWM controller is a current mode Boost converter integrated with a 250mΩ, 36V power switch and can cover a wide VIN range from 2.7V to 24V and contains I²C interface.

OCP

When LX N-MOSFET peak current is higher than 2.5A (typically), the LX N-MOSFET is turned off immediately and resumes again at next clock pulse.

OTP

The RT4539 equips an Over Temperature Protection (OTP) circuitry to prevent overheating due to excessive power dissipation. The OTP will shut down switching operation when junction temperature exceeds 150°C. Once the junction temperature cools down by approximately 30°C, the boost converter will resume operation. To maintain continuous operation maximum, the junction temperature should be prevented from rising above 125°C.

OVP

The RT4539 integrates over-voltage protection. The over-voltage protection could be set by the I²C. When the OVP pin voltage is higher than 40V, the LX N-MOSFET is turned off immediately to protect the LX N-MOSFET.

Minimum LED Selection

This block detects all LEDx voltage and selects a minimum voltage to EA (Error Amplifier). This function can guarantee that the lowest voltage of the LED pin is around 400mV and V_{OUT} can be boosted to the highest forward voltage of LED strings.

LED Open Detection

If the voltage at LEDx pin is lower than 100mV, this channel is defined as open channel and the Minimum LED Selection function will discard it to regulate other used channels in proper voltage.

LED String Short Detection

If CHx pin voltages exceed the threshold of approximately 5.6V during normal operation, the channels will be turned off and it can be reset by EN or VIN UVLO.

Absolute Maximum Ratings (Note 1)

- Supply Voltage, VIN to GND ----- -0.3V to 26.4V
- LX, VOUT, FB1, FB2, FB3, FB4, FB5, FB6 to GND ----- -0.3V to 42V
- EN, PWM, SDA, SCL, VCP to GND ----- -0.3V to 6V
- Power Dissipation, PD @ TA = 25°C
 WL-CSP-20B 1.71x2.371 (BSC)----- 3.02W
- Package Thermal Resistance (Note 2)
 WL-CSP-20B 1.71x2.371 (BSC), θJA----- 33.1°C/W
- Lead Temperature (Soldering, 10 sec.)----- 260°C
- Junction Temperature----- 150°C
- Storage Temperature Range----- -65°C to 150°C
- ESD Susceptibility (Note 3)
 HBM (Human Body Model) ----- 2kV

Recommended Operating Conditions (Note 4)

- Ambient Temperature Range ----- -40°C to 85°C
- Junction Temperature Range ----- -40°C to 125°C

Electrical Characteristics

(VIN = 3.8V, TA = 25°C, unless otherwise specified)

Parameter	Symbol	Test Conditions	Min	Typ	Max	Unit
Input Power Supply						
Input Supply Voltage	VIN		2.7	3.8	24	V
Quiescent Current	IQ	LX no switching, PWM duty = 0%	1.5	2.4	3.7	mA
Shutdown Current	ISHDN	VIN = 3.8V, EN = 0V	--	--	10	µA
Under-Voltage Lockout Threshold	VUVLO	VIN rising	1.88	2.3	2.72	V
Under-Voltage Lockout Hysteresis	ΔVUVLO		50	200	470	mV
Over-Temperature Protection Threshold	TOTP		--	150	--	°C
Over-Temperature Protection Hysteresis	TOTP_HYS		--	30	--	°C
Internal LDO Voltage	VCP	No load	3.1	3.4	3.7	V
Interface Characteristic						
EN, PWM, SCL, SDA Input Voltage	Logic-High	VIH	1.2	--	--	V
	Logic-Low	VIL	--	--	0.6	V
Internal pull low resistor for EN, PWM	RPULL_LOW		0.5	1.3	2	MΩ
Internal Pull-Low Current for SCL, SDA	IiH_2		--	0.01	1	µA
Output Low Level for SDA	VOL	External pull high current = 3mA	--	0.3	0.5	V
Output Leakage Current for SDA	ILK_DIO	SDA pin voltage = 3.3V	--	--	1	µA

Parameter	Symbol	Test Conditions	Min	Typ	Max	Unit
I²C Interface Timing						
Maximum I ² C Clock Frequency	f _{SC_MAX}		1	--	400	kHz
Hold Time for START And Repeated START Condition	t _{HD,STA}		0.6	--	--	μs
SCL Clock Low Time	t _{LOW}		1.3	--	--	μs
SCL Clock High Time	t _{HIGH}		0.6	--	--	μs
Setup Time for A Repeated START Condition	t _{SU,STA}		0.6	--	--	μs
SDA Data Hold Time	t _{HD,DAT}		0	--	900	ns
SDA Data Setup Time	t _{SU,DAT}		100	--	--	ns
Rising Time of SDA, SCL	t _R		20	--	300	ns
Falling Time of SDA, SCL	t _F		20	--	300	ns
Setup Time for STOP Condition	t _{SU,STO}		0.6	--	--	μs
I ² C Bus Free Time Between a STOP and a START	t _{BUF}		1.3	--	-	μs
Capacitive Load for I ² C Bus	C _B		--	--	400	pF
Boost Converter						
Switching Frequency Accuracy	f _{SW_ACC}	Boost operates at PWM mode, f _{sw} = 600kHz	-10	--	10	%
Switching Frequency Setting Range	f _{SW_RG}	Boost operates at PWM mode default = 600kHz@0x07h	0.3	--	1.6	MHz
Maximum Duty Cycle	D _{MAX_300kHz to 1MHz}	f _{sw} = 300kHz to 1MHz (Note 6)	85	90	95	%
	D _{MAX_1.22MHz to 1.6MHz}	f _{sw} = 1.22MHz to 1.6MHz (Note 6)	90	95	99	
Boost Switch R _{DS(ON)}	R _{DS(ON)}		0.07	0.25	0.29	Ω
Switching Current Limitation	I _{OCP}	(Note 7)	2	2.5	3	A
Boost Minimum ON Time	t _{MON}		10	100	300	ns
V _{OUT} Over-Voltage Protection	V _{OVP}	Register address = "0Ah", 5 bits Step = 1V, default = 36V, C _{OUT} = 4.7μF	35.08	36	36.92	V
LED Current						
Leakage Current of FBx	I _{LK_FB}	V _{FBx} = 36V, I _{FBx} = 0mA	--	--	2	μA
Minimum FBx Regulation Voltage	V _{FB(MIN)}	I _{FBx} = 20mA * 97%	0.35	--	--	V
Maximum LED Current Setting	I _{FB(MAX)}	LED 100% setting, register address = "02h", Step = 0.12mA	10.04	--	35	mA
Minimum LED Current Setting	I _{FB(MIN)}	Setting By Dimming, I _{FBx} = 20mA	0.2	--	--	mA

Parameter	Symbol	Test Conditions	Min	Typ	Max	Unit
LED Current Accuracy	IFB_ACC_100	PWM Duty = 100%, I _{FBx} = 20mA, PWM frequency = 1kHz	-3	--	3	%
	IFB_ACC_5	PWM Duty = 5%, I _{FBx} = 20mA, PWM frequency = 1kHz	-5	--	5	
	IFB_ACC_1	PWM Duty = 1%, I _{FBx} = 20mA, PWM frequency = 1kHz	-15	--	15	
LED Current Matching	IFB_MAT_100	PWM Duty = 100%, I _{FBx} = 20mA, PWM frequency = 1kHz	-2	--	2	%
	IFB_MAT_5	PWM Duty = 5%, I _{FBx} = 20mA, PWM frequency = 1kHz	-5	--	5	
	IFB_MAT_1	PWM Duty = 1%, I _{FBx} = 20mA, PWM frequency = 1kHz	-10	--	10	
DC Dimming Resolution	Sres_2k	PWM Freq < 2kHz, 0x07h[1:0]=B00, 0x00h[2:0]=B100.	--	4095	--	Steps
	Sres_4k	PWM Freq = 2k to 4kHz, 0x07h[1:0]=B00, 0x00h[2:0]=B100.	--	2048	--	Steps
	Sres_8k	PWM Freq = 4k to 8kHz, 0x07h[1:0] = B00, 0x00h[2:0] = B100.	--	1024	--	Steps
	Sres_20k	PWM Freq = 8k to 20kHz, 0x07h[1:0]=B00, 0x00h[2:0] = B100	--	512	--	Steps
Light Bar Open Threshold	V _{FB_OPEN}		0.01	0.1	0.34	V
Light Bar Short Threshold	V _{LED_SHORT}		3.9	5.6	7.3	V
PWM Minimum On Time	DPWM_MIN	PWM dimming frequency = 20kHz	--	400	--	ns

Note 1. Stresses beyond those listed under “Absolute Maximum Ratings” may cause permanent damage to the device. These are stress ratings only, and functional operation of the device at these or any other conditions beyond those indicated in the operational sections of the specifications is not implied. Exposure to absolute maximum rating conditions may affect device reliability.

Note 2. θ_{JA} is measured under natural convection (still air) at T_A = 25°C with the component mounted on a high effective-thermal-conductivity four-layer test board on a JEDEC 51-7 thermal measurement standard. θ_{JC} is measured at the exposed pad of the package.

Note 3. Devices are ESD sensitive. Handling precautions are recommended.

Note 4. The device is not guaranteed to function outside its operating conditions.

Note 5. VIN voltage has to rise 2.8V level, I²C can write to MTP.

Note 6. Operating conditions are recommended to be less than the maximum duty cycle.

If dimming control selected PWM mode or PWM-26KHz mode, the conversion ratio is recommended to be less than 0.75, as following equation : (1-(Vin/Vout)) < 0.75.

Note 7. Operating conditions is recommended to be less than OCP level * 90%.

Typical Application Circuit

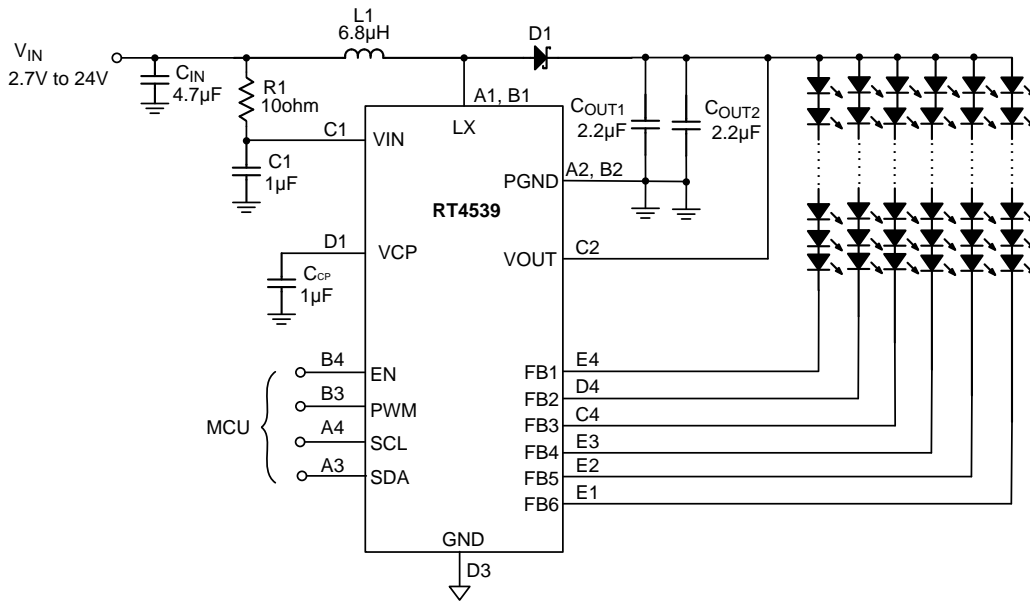

Timing Diagram

I²C Interface

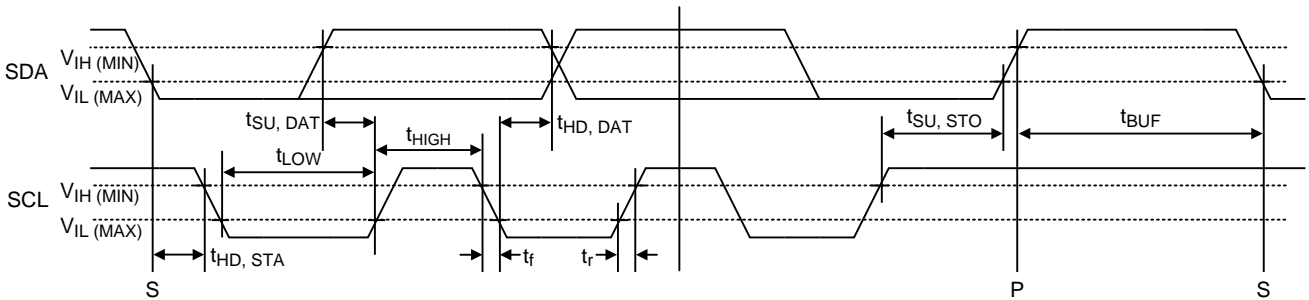

RT4539 I²C slave address = 7'b0111_100. The I²C interface supports fast mode (bit rate up to 400kb/s). The write or read bit stream (N ≥ 1) is shown below :

Read N bytes from RT4539

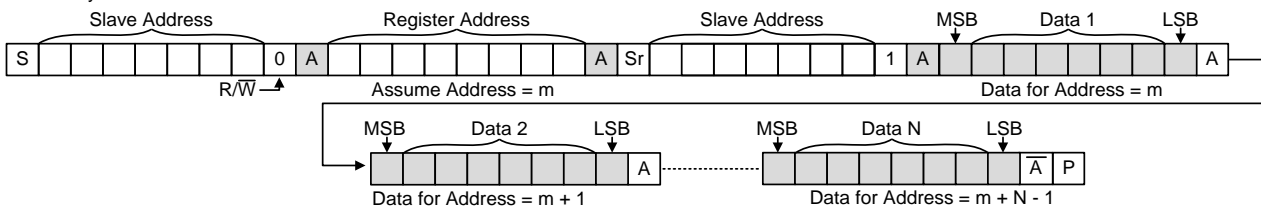

Write N bytes to RT4539

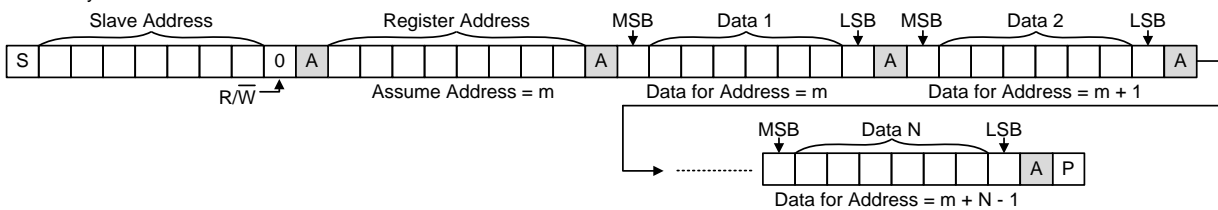

□ Driven by Master, □ Driven by Slave (RT4539), □ P Stop, □ S Start, □ Sr Repeat Start

Typical Operating Characteristics

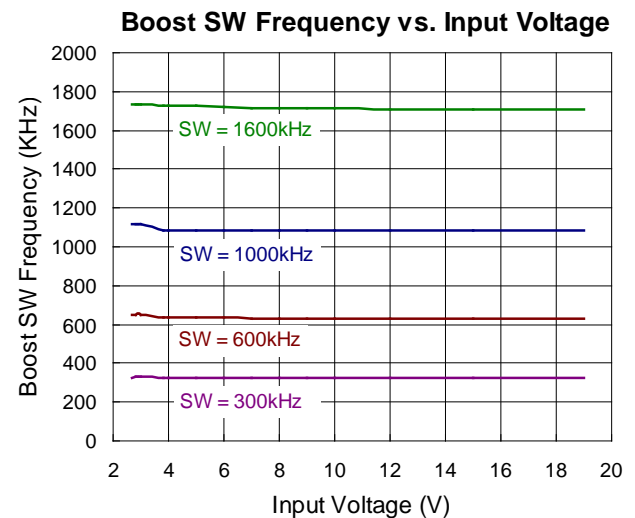
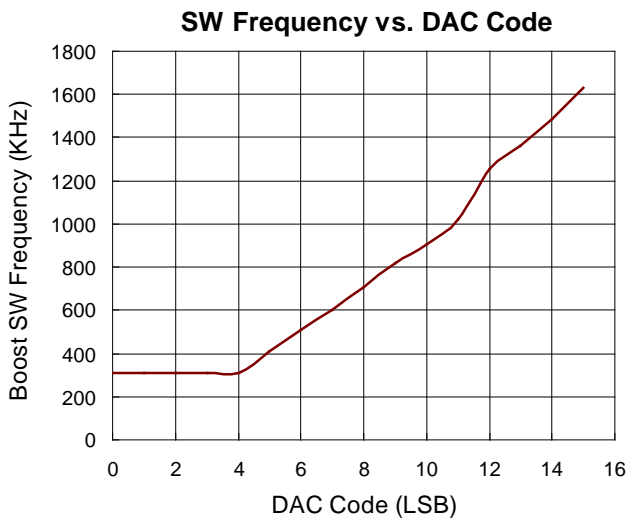
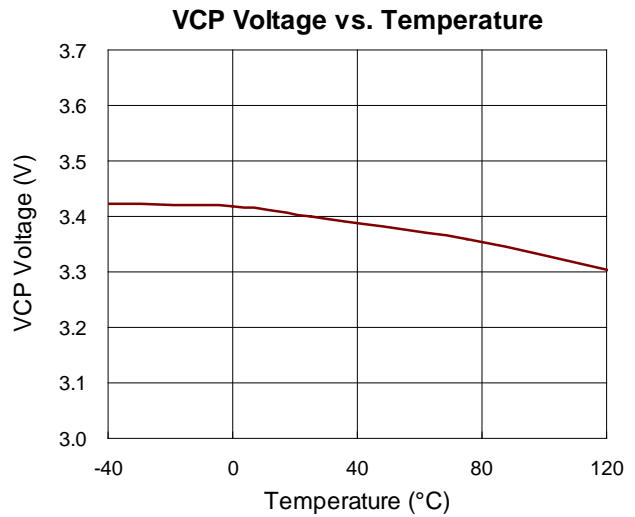
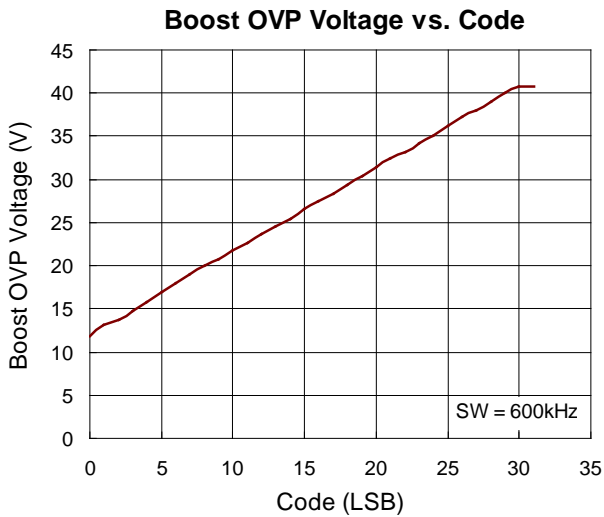
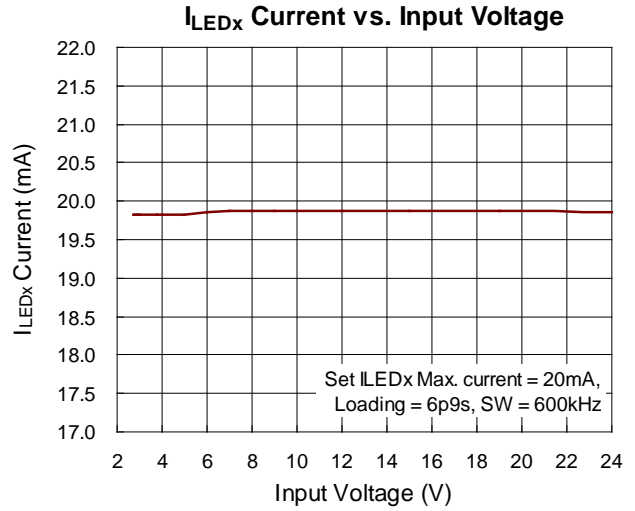
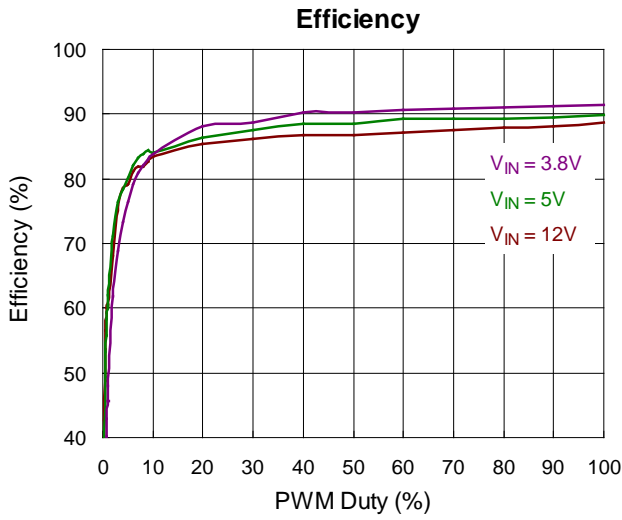

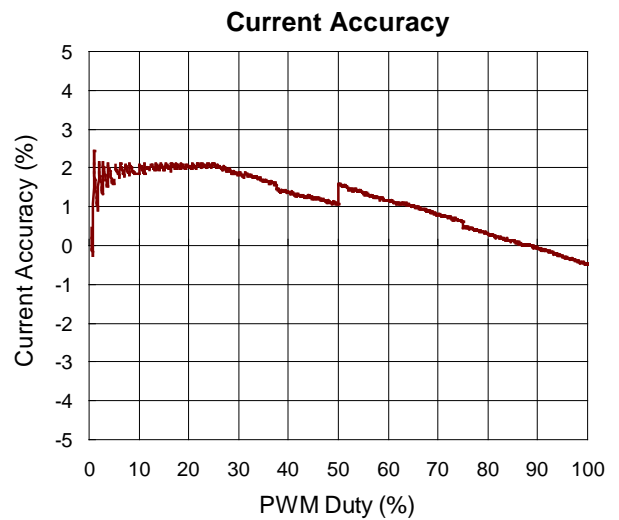
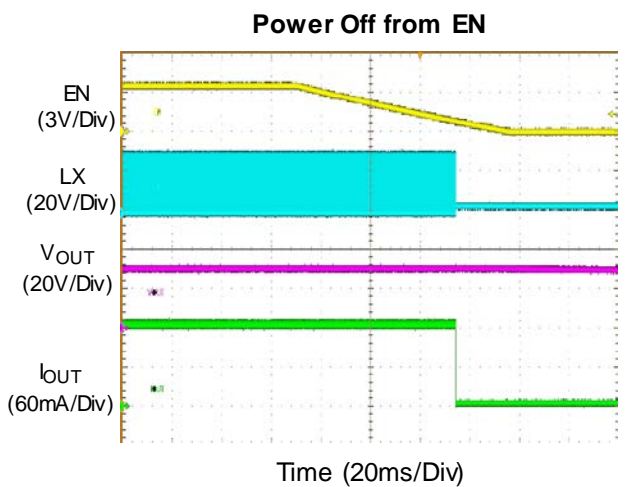
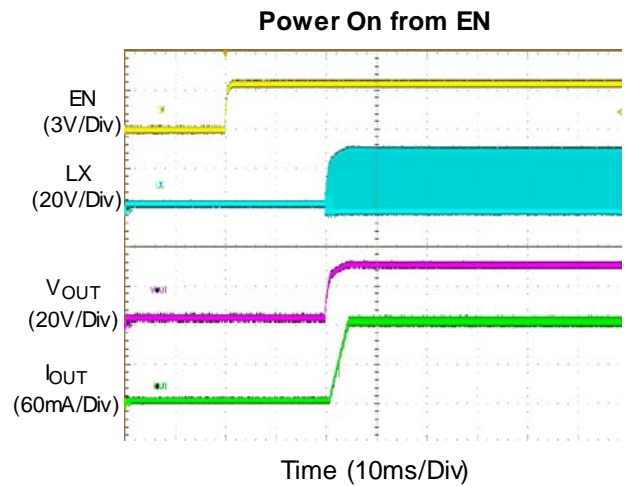
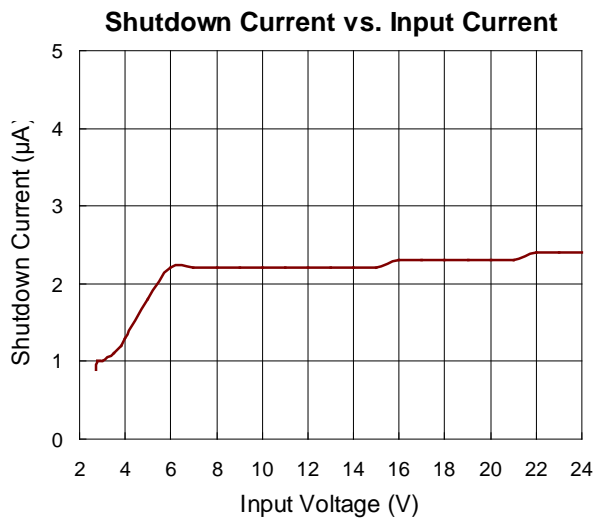
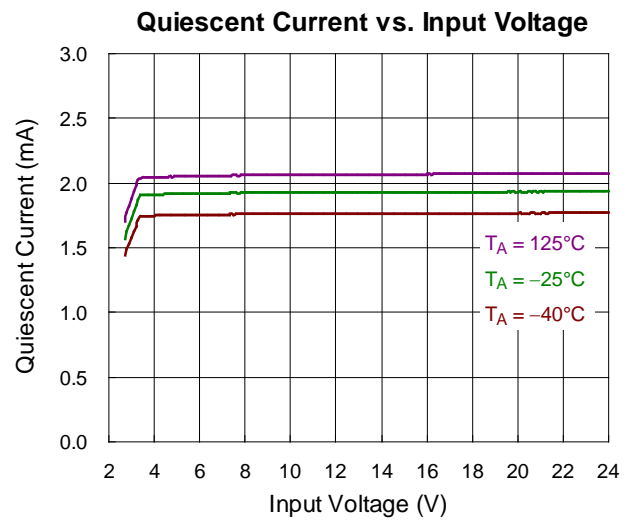
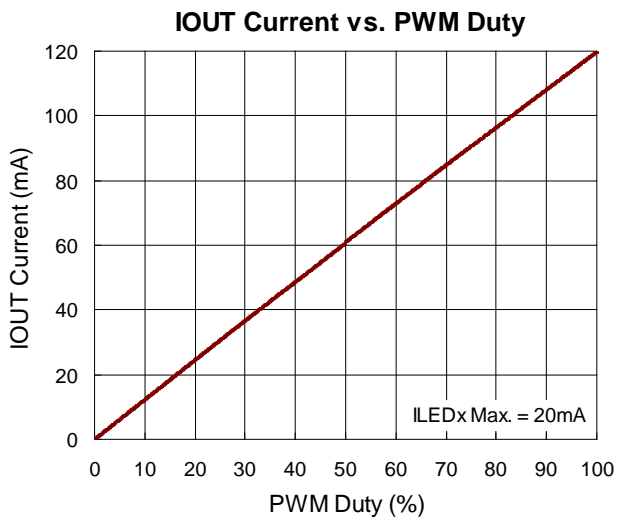

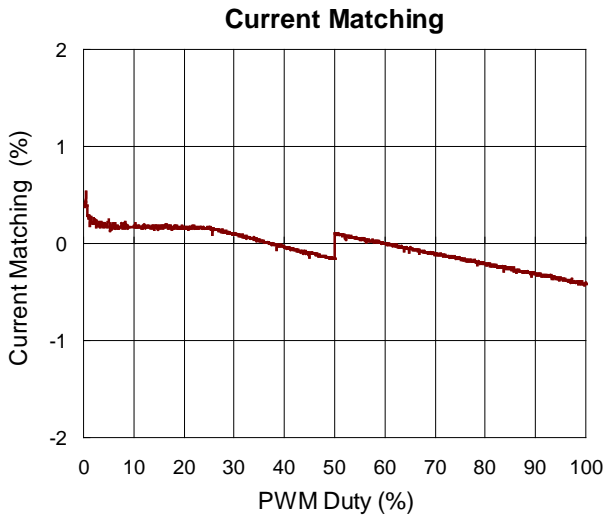

Application Information

Table 1. Register Map

Slave Address : b0111_100									
Register Address	bit7	bit6	bit5	bit4	bit3	bit2	bit1	bit0	Default Value
0x00	Spread Spectrum	LX Edge Rate Control			Mixed Mode Change Duty	Dimming Mode Selection			0x6B
0x01				Switching Current Limitation Selection	Boost Switching Frequency				0x17
0x02	ILED Current Setting								0x82
0x03	ILED Mapping Mode	LED driver headroom				Bit selection			0x04
0x04					ILED Brightness MSB Register				0x00
0x05	ILED Brightness LSB Register								0x00
0x06	Filter		Slope Time Control			Fade In / Out Time Control			0xA8
0x07	PWM sample rate						Advanced Brightness Control		0x00
0x08	26KHz Mode Division Frequency						Soft Start Time Control		0x00
0x09		Lowest Switching Frequency for PFM						Control CLK PFM Function Enable	0x78
0x0A	LED Short Protection	LED OVP Level		Boost Over-voltage Protection selection					0x1A
0x0B	BL_EN	FB6_EN	FB5_EN	FB4_EN	FB3_EN	FB2_EN	FB1_EN		0xFE
0xFF	MTP Programming							MTP Read	0x00

Note : Blank parts in this table are restricted registers.

The RT4539 is a general purpose 6-CH LED driver and is capable of delivering a maximum 35mA LED current. The IC is a current mode Boost converter integrated with a 2.5A power switch and can cover a wide VIN range from 2.7V to 24V. Moreover, the IC contains I²C interface for controlling the dimming mode, operating frequency and the LED current. The internal 250mΩ, 36V power switch with current-mode control provides over-current protection. The switching frequency of the RT4539 is adjustable from 300kHz to 1.6MHz, which allows flexibility between efficiency and component size.

Programmable functions include:

- ▶ PWMO frequency.
- ▶ LED constant current
- ▶ Spread Spectrum
- ▶ LX Edge Rate Control
- ▶ Mixed Mode Change Duty
- ▶ Dimming Mode Selection
- ▶ Switching Current Limitation Selection
- ▶ Boost switching frequency
- ▶ LED Mapping Mode
- ▶ LED Driver Headroom setting
- ▶ Resolution Bit Selection
- ▶ Filter Selection for smooth dimming modification

- ▶ Slope Time Control Function
- ▶ Fade in/out Time Control
- ▶ PWM Sample Rate Selection
- ▶ Advanced Brightness Control
- ▶ 26KHz Mode Division Frequency
- ▶ Soft Start Time Control
- ▶ Lowest Switching Frequency for PFM
- ▶ PFM Function Enable
- ▶ LED Short Protection
- ▶ LED OVP Level Selection
- ▶ Boost Over-Voltage Protection Selection
- ▶ BL Control Enable
- ▶ FB1~FB6 Control Enable
- ▶ LED Current Setting
- ▶ Exponential function for smooth dimming modification

Dimming Control Mode Selection

The RT4539 provides five dimming modes for controlling the LED brightness. These functions include PWM mode, PWM-26k Mode, Mixed Mode, Mixed-26k Mode, DC mode and change duty threshold of mixed mode. The dimming control mode selection is programmable by register address 00h.

Table 2. Dimming Control Mode Selection

Address	Bit	Name	Default Value	Description	R/W
00h	[2:0]	Dimming Mode Selection	Mixed-26k Mode (B011)	B000: PWM Mode (Direct PWM) B001: PWM-26k Mode (Non-Direct PWM) B010: Mixed Mode B011: Mixed-26k Mode B100: DC Mode	R/W
	[3]	Mixed Mode Change Duty	25% (B1)	B0: 12.5% B1: 25%	R/W

PWM Mode

The ON/OFF of the current source is synchronized to the PWM signal. The frequency of LED current is equal to the PWM input signal.

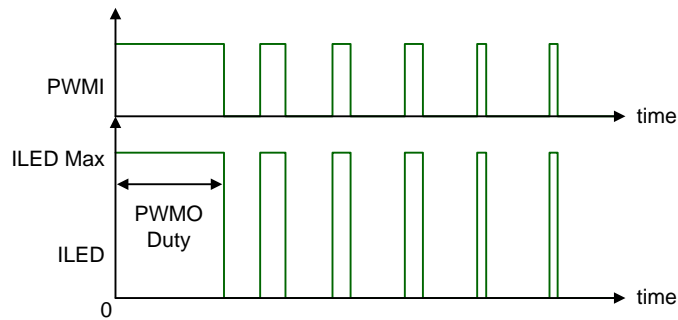

Figure 1. PWM Dimming

DC Mode

The LED current will have two-cycle delay in this mode, while the delay cycles are for average current calculation.

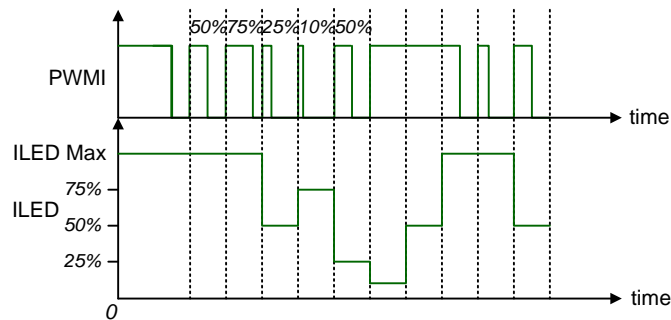

Figure 2. DC Dimming

Mixed Mode

The ILED will delay for two periods to response. The first cycle delay is required for period, while the second cycle delay is for the duty rate calculation.

- ▶ When $25\% \leq \text{PWM duty} \leq 100\%$, the current source outputs are DC dimming, and the PWM duty cycle modulates the amplitude of the currents in 100% dimming.
- ▶ PWM duty $< 25\%$, the DC dimming will translate to PWM dimming, controlling the PWM duty instead by amplitude. The LED current is fixed on quarter of LED current setting.

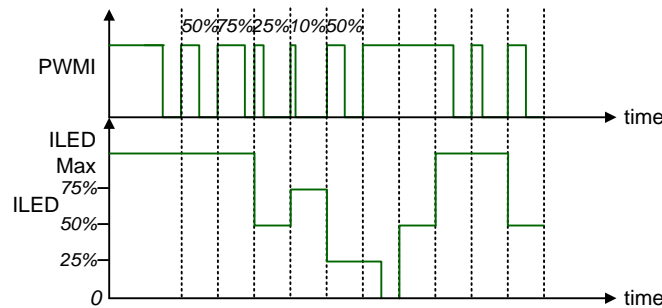

Figure 3. Mixed Mode Dimming

*During DC / Mix Mode dimming, the behavior of PWM Duty 100% and 0% ILED are shown in the following Figure.

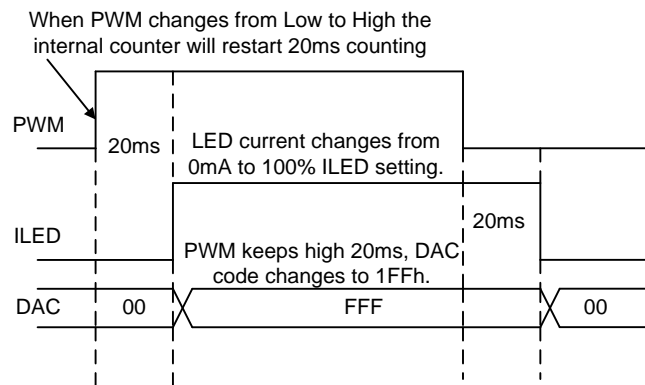

Figure 4. Duty 100% and Duty 0% ILED Behavior

Switching Frequency and LX Slew Rate Control

In order to improve EMI performance, the boost converter embeds switching frequency, spread spectrum and LX edge rate control feature, and these functions are programmable by the I2C interface. The more detailed settings are shown in Table 3 and Table 4.

Table 3. Switching Frequency and LX Slew Rate Setting

Address	Bit	Name	Default Value	Description	R/W
00h	[6:5]	LX Edge Rate Control	200% (B11)	B00 : 25% B01 : 50% B10 : 100% B11 : 200%	R/W
	[7]	Spread Spectrum	w/o (B0)	B0 : w/o B1 : w/i	R/W
01h	[3:0]	Boost Switching Frequency	600kHz (0x07h)	0x00h ~ 0x04h : 300kHz 0x0Fh : 1600kHz (Table)	R/W

If the switching frequency command is below to register 0x01, the switching frequency is from 300kHz to 1.6MHz.

Table 4. Switching Frequency

Boost Switching Frequency [3:0]	Frequency
0x00h	300kHz
0x01h	300kHz
0x02h	300kHz
0x03h	300kHz
0x04h	300kHz
0x05h	400kHz
0x06h	500kHz
0x07h	600kHz
0x08h	700kHz
0x09h	800kHz
0x0Ah	900kHz
0x0Bh	1000kHz
0x0Ch	1225kHz
0x0Dh	1335kHz
0x0Eh	1450kHz
0x0Fh	1600kHz

Current-Limit Protection

The RT4539 integrates current-limit protection and can limit the peak current to achieve over-current protection. The RT4539 senses the inductor current that flows through the LX pin. During the “ON” period, the duty cycle depends on the current signal, and internal slope compensation is compared with the error signal. The internal switch of Boost converter will be turned off when the peak current value of inductor current is larger than the over-current protection setting. In the “OFF” period, the inductor current will be decreased until the internal switch is turned on by the oscillator.

Current-limit protection can be set by I²C interface and more details are shown in Table 5.

Table 5. Current-Limit Protection Setting

Address	Bit	Name	Default Value	Description	Resolution	R/W
01h	[4]	Switching Current Limitation Selection	2.5A (B1)	B0 : 1.5A B1 : 2.5A	--	R/W

LED Current Setting

The LED current of each channel can be set by I²C interface and more details are shown in Table 6.

Set Maximum LED current as shown below. This maximum current is scaled as described in the 0x02h Register.

Address	Bit	Name	Default Value	Description	Resolution	R/W
02h	[7:0]	ILED Current Setting	20mA (0x82h)	Control the max current 0x00h : 0mA 0x01h to 0x2Fh : 10.04mA 0x82h : 20mA 0xFFh : 35mA	~0.12mA (0x2Fh to 0xFFh)	R/W

When the LED current setting command is below 0x82h, the LED current will be kept at 20mA. When the command is 0x00h, the LED current will be set to 0mA. The maximum LED current setting is 35mA. The one step of LED current is approximately 0.12mA.

Table 6. LED Current Setting

ILED (mA)	0x02h <7:0>	ILED (mA)	0x02h <7:0>	ILED (mA)	0x02h <7:0>	ILED (mA)	0x02h <7:0>	ILED (mA)	0x02h <7:0>
35.00	FF	29.24	CF	23.48	9F	17.72	6F	11.96	3F
34.88	FE	29.12	CE	23.36	9E	17.60	6E	11.84	3E
34.76	FD	29.00	CD	23.24	9D	17.48	6D	11.72	3D
34.64	FC	28.88	CC	23.12	9C	17.36	6C	11.60	3C
34.52	FB	28.76	CB	23.00	9B	17.24	6B	11.48	3B
34.40	FA	28.64	CA	22.88	9A	17.12	6A	11.36	3A
34.28	F9	28.52	C9	22.76	99	17.00	69	11.24	39
34.16	F8	28.40	C8	22.64	98	16.88	68	11.12	38
34.04	F7	28.28	C7	22.52	97	16.76	67	11.00	37
33.92	F6	28.16	C6	22.40	96	16.64	66	10.88	36
33.80	F5	28.04	C5	22.28	95	16.52	65	10.76	35
33.68	F4	27.92	C4	22.16	94	16.40	64	10.64	34
33.56	F3	27.80	C3	22.04	93	16.28	63	10.52	33
33.44	F2	27.68	C2	21.92	92	16.16	62	10.40	32
33.32	F1	27.56	C1	21.80	91	16.04	61	10.28	31
33.20	F0	27.44	C0	21.68	90	15.92	60	10.16	30
33.08	EF	27.32	BF	21.56	8F	15.80	5F	10.04	01~2F
32.96	EE	27.20	BE	21.44	8E	15.68	5E	10.04	
32.84	ED	27.08	BD	21.32	8D	15.56	5D	10.04	
32.72	EC	26.96	BC	21.20	8C	15.44	5C	10.04	
32.60	EB	26.84	BB	21.08	8B	15.32	5B	0.00	0
32.48	EA	26.72	BA	20.96	8A	15.20	5A		
32.36	E9	26.60	B9	20.84	89	15.08	59		
32.24	E8	26.48	B8	20.72	88	14.96	58		
32.12	E7	26.36	B7	20.60	87	14.84	57		
32.00	E6	26.24	B6	20.48	86	14.72	56		
31.88	E5	26.12	B5	20.36	85	14.60	55		
31.76	E4	26.00	B4	20.24	84	14.48	54		
31.64	E3	25.88	B3	20.12	83	14.36	53		
31.52	E2	25.76	B2	20.00	82	14.24	52		
31.40	E1	25.64	B1	19.88	81	14.12	51		

ILED (mA)	0x02h <7:0>	ILED (mA)	0x02h <7:0>	ILED (mA)	0x02h <7:0>	ILED (mA)	0x02h <7:0>	ILED (mA)	0x02h <7:0>
31.28	E0	25.52	B0	19.76	80	14.00	50		
31.16	DF	25.40	AF	19.64	7F	13.88	4F		
31.04	DE	25.28	AE	19.52	7E	13.76	4E		
30.92	DD	25.16	AD	19.40	7D	13.64	4D		
30.80	DC	25.04	AC	19.28	7C	13.52	4C		
30.68	DB	24.92	AB	19.16	7B	13.40	4B		
30.56	DA	24.80	AA	19.04	7A	13.28	4A		
30.44	D9	24.68	A9	18.92	79	13.16	49		
30.32	D8	24.56	A8	18.80	78	13.04	48		
30.20	D7	24.44	A7	18.68	77	12.92	47		
30.08	D6	24.32	A6	18.56	76	12.80	46		
29.96	D5	24.20	A5	18.44	75	12.68	45		
29.84	D4	24.08	A4	18.32	74	12.56	44		
29.72	D3	23.96	A3	18.20	73	12.44	43		
29.60	D2	23.84	A2	18.08	72	12.32	42		
29.48	D1	23.72	A1	17.96	71	12.20	41		
29.36	D0	23.60	A0	17.84	70	12.08	40		

LED Driver Headroom

The LED driver headroom can be set by the I²C interface and more setting details are shown in Table 7.

This adjusts the Minimum headroom selected comparator threshold with address 0x03h and contributes to the error amplifier, moreover regulates an optimized output voltage for high efficiency.

Table 7. LED Driver Headroom

Address	Bit	Name	Default Value	Description	Resolution	R/W
03h	[6:5]	LED driver headroom	400mV (B00)	LED driver headroom B00 : 400mV B01 : 450mV B10 : 500mV B11 : 600mV	--	R/W

The RT4539 detects all FBx voltage and selects a minimum voltage to EA (Error Amplifier). When the LED driver headroom command is below B00, the LED driver headroom will be kept at 400mV and V_{OUT} can be boosted to the highest forward voltage of LED strings. This function can guarantee that the highest of FB pin voltage is 600mV.

Brightness Control by Address 0x03h/0x04h/0x05h Register

The RT4539 equips various methods of brightness control, including Dimming resolution bit selection, ILED Mapping (Linear or exponential) mode selection and LED brightness setting. The brightness can be controlled using an external PWM signal or the brightness register accessible by users via an I²C interface or both. The 8-bits in address 0x05h register (LSB) along the 4-bits defined in address 0x04h register (MSB) allow LED brightness to be set in 12-bit fine steps. More setting details are shown in Table 8.

Table 8. Brightness Register

Address	Bit	Name	Default Value	Description	R/W
03h	[2:0]	Bit Selection	12bit (B100)	Brightness Control by I ² C Register B000: 8bit (both linear and exponential) B001: 9bit (both linear and exponential) B010: 10bit (both linear and exponential) B011: 11bit (both linear and exponential) B100: 12bit (Linear only)	R/W
	[7]	ILED Mapping Mode	Linear (B0)	B0: Linear B1: Exponential (DC Mode only)	R/W
04h	[3:0]	ILED Brightness MSB Register	0% (0x00h)	If 03h[2:0] bit selection is 9bit~12bit, 04h & 05h series write is needed and then ILED brightness changes	R/W
05h	[7:0]	ILED Brightness LSB Register	0% (0x00h)	0x00h: 0% 0xFFh: 100%	R/W

ILED Brightness Exponential Mapping

The RT4539 embeds an advanced exponential transition function during brightness change to make it more pleasing to a human eye. The exponential calculation follows the equation below and the resolution is up to 11 bits.

$$I_{LED} = I_{LED_{min}} \times K^{BRT\ Code}$$

(for codes > 0 & Code 0 disables the backlight)

Where K = 1.00304

The exponential function uses different input signal types to calculate target ILED and can be programmed with advanced brightness control register. More setting details are shown in Table 12.

The exponential function is valid for DC mode only and an example is described in the following Figure.

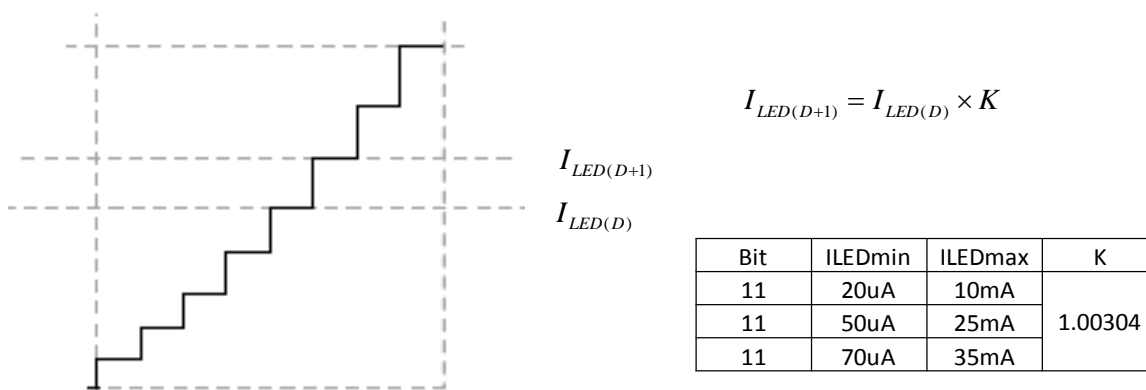

Figure 5

Advanced Brightness Control

Dimming control is received either from PWM input pin or from I²C interface. Through I²C interface, both of 0x04h and 0x05h are used to control brightness. Moreover, the 8-bits in address 0x05h register (LSB) along the 4-bits defined in address 0x04h register (MSB) allow LED brightness to be set in 12-bit fine steps.

More setting details are shown in following Table 9.

Table 9. Advanced Brightness Control

Address	Bit	Name	Default Value	Description	R/W
07h	[1:0]	Advanced Brightness Control	External PWM signal (B00)	B00 : External PWM signal B01 : I ² C brightness register (04h, 05h) B10 : External PWM signal multiplied with I ² C brightness register (04h, 05h)	R/W

The dimming mode can be programmed by address 0x00h register but the exponential function is valid for DC mode only. If users select PWM mode, the PWM and/or I²C interface will directly control the LED current. In the following section, we will describe how to set address 0x07h by DC mode only.

LED Current with Advanced Brightness Control Selection “00”

LED brightness mapping can be selected to be either linear or exponential (DC mode only) by address 0x03h [7].

When address 0x07h is set to B00 and exponential mode is selected by address 0x03h, the PWM duty will transfer cycle-to-current response with 11-bit resolution and target I_{LED} is approximated by the following equation:

$$I_{LED} = 50\mu A \times 1.00304^{2047 \times PWM \text{ duty}} \text{ (for PWM duty} \neq 0 \text{) @ } I_{LED_{max}} = 25mA$$

It is valid for PWM duty cycles within 0~100%. If duty cycle is 0, the brightness will be disabled.

When address 0x07h is set to B00 and linear mode is selected by address 0x03h, the PWM duty will transfer cycle-to-current response with 12-bit resolution and target I_{LED} is approximated by the following equation :

$$I_{LED} = 6.105\mu A \times 4095 \times PWM \text{ duty (for PWM duty} \geq 0 \text{) @ } I_{LED_{max}} = 25mA$$

It is valid for PWM duty cycles within 0~100%. If duty cycle is 0, the brightness will be disabled.

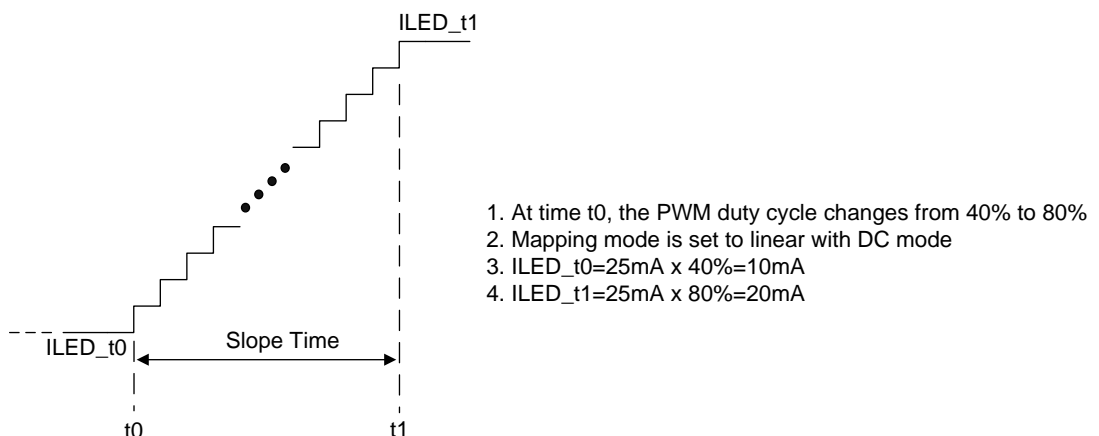

Figure 6.

LED Current with Advanced Brightness Control Selection “01”

LED brightness mapping can be selected to be either linear or exponential (DC mode only) by address 0x03h [7].

When address 0x07h is set to B01 and exponential mode is selected by address 0x03h, the I²C interface will transfer code-to-current response with 11-bit resolution and target I_{LED} is approximated by the following equation :

$$I_{LED} = 50\mu A \times 1.00304^{I^2C \text{ code}} \text{ (for codes} > 0 \text{) @ } I_{LED_{max}} = 25mA$$

This equation is valid for I²C brightness codes between 1 and 2047. If Code is 0, the brightness will be disabled. When address 0x07h is set B01 and linear mode is selected by address 0x03h, the I²C interface will transfer code-to-current response with 12-bit resolution and target ILED is approximated by following equation:

$$I_{LED} = 6.105\mu A \times I^2C \text{ code (for codes} \geq 0) @ I_{LED_max} = 25mA$$

This equation is valid for I²C brightness codes between 0 and 4095. If Code is 0, the brightness will be disabled.

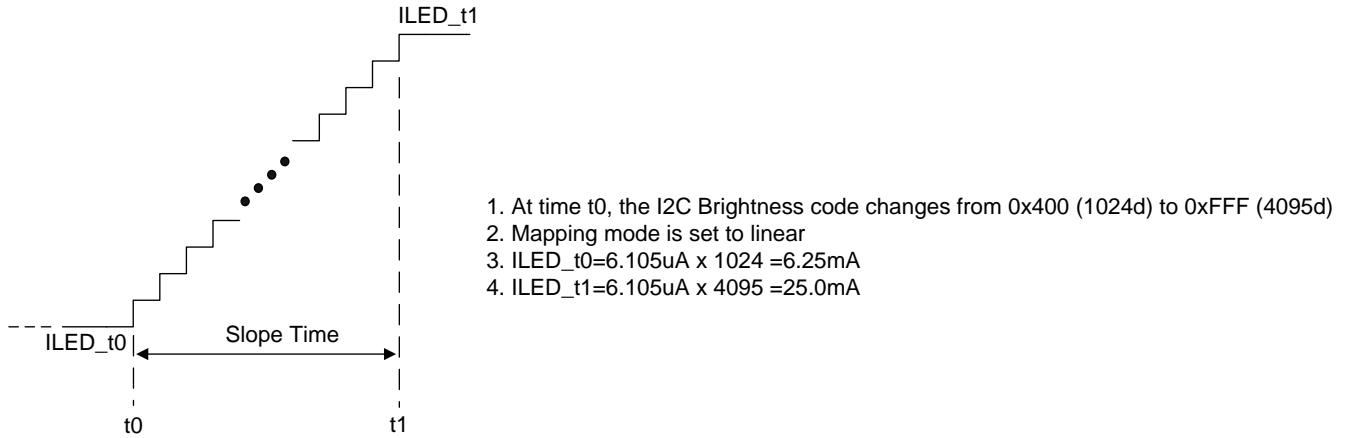

Figure 7.

LED Current with Advanced Brightness Control Selection “10”

When address 0x07h is set to B10, this mode is only for DC mode and linear mapping.

The target brightness code will be multiplied with the PWM duty cycle and I²C code. Moreover, resolution can support up to 12 bits.

The target ILED is approximated by the following equation :

$$I_{LED} = 6.105\mu A \times I^2C \text{ code} \times 4095 \times \text{PWM duty (for codes} \geq 0 \ \& \ \text{PWM duty} \neq 0\% \ \& \ 100\%) @ I_{LED_max} = 25mA$$

(Note 7)

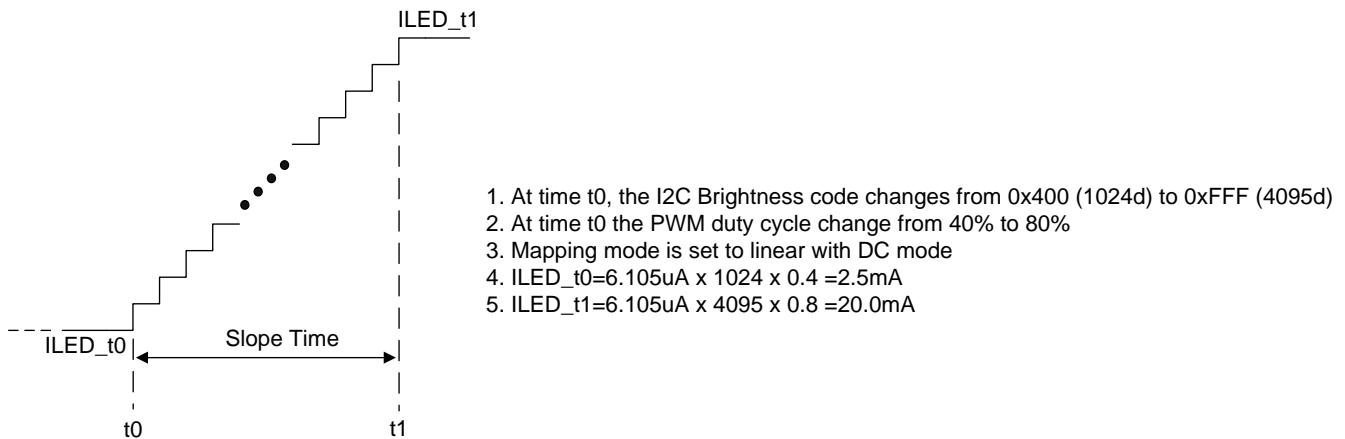

Figure 8

The following table is the critical condition for PWM Cycle setting. When PWM Duty = 0% or PWM Duty = 100%, ILED will not consider I²C Code.

Table 10

I ² C Code	PWMI Duty (%)	I _{LED} current
Don't care	0	0%
I ² C code	1	6.105uA x I ² C code x 4095 x PWM duty
I ² C code	50	
I ² C code	99	
Don't care	100	100%

Fade IN / OUT Time Control

The fade in / out time control can be set by the I²C interface. More setting details are shown in Table 11.

Table 11. Fade In / Out Time Control

Address	Bit	Name	Default Value	Description	R/W
06h	[2:0]	Fade IN / OUT Time Control	0.5μs (B000)	DC mode fade time control B000: 0.5μs B001: 1μs B010: 2μs B011: 4μs B100: 8μs B101: 16μs B110: 32μs B111: 64μs	R/W

Fade in / out time can be controlled by address 06h [2:0]. There are eight brightness times that adjust range from 0.5μs to 64μs. When the fade in/out command is B000, the brightness time of per step will be at 0.5μs. This function can guarantee the highest of fade in/out time is 64μs. Figure 9 shows the fade in time at 10-bit resolution. Figure 10 shows the fade out time at 10-bit resolution.

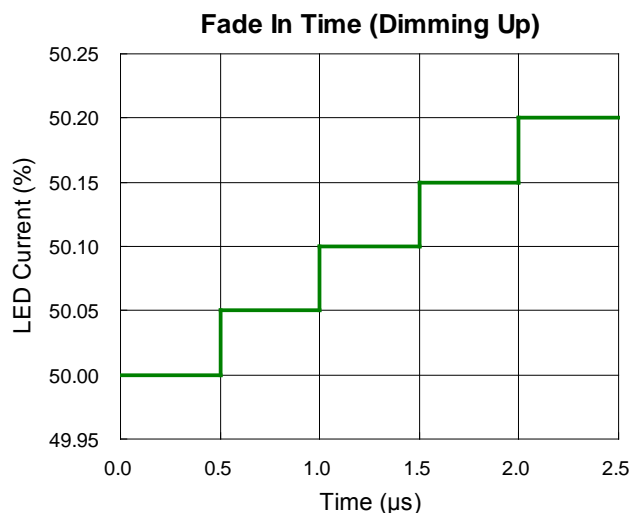

Figure 9. LED Current (Dimming Up) vs. Fade In Time

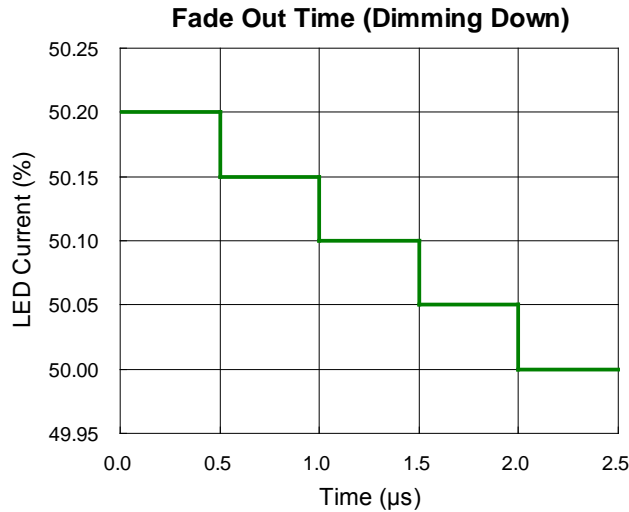

Figure 10. LED Current (Dimming Down) vs. Fade Out Time

Normal Slope and Advanced Slope

Transition time between two brightness value can be controlled linearly by address 06h[5:3] from 0 to 1024ms. Same slope time is used for sloping up and down. With advanced slope, the brightness changes can be made more smoothing to a human eye.

Table 12. Slope Time Control

Address	Bit	Name	Default Value	Description	R/W
06h	[5:3]	Slope Time Control	512ms (B101)	B000: 0ms B001: 1ms B010: 8ms B011: 128ms B100: 256ms B101: 512ms B110: 768ms B111: 1024ms	R/W
	[7:6]	Filter	medium smoothing (B10)	B00: No Filter (exponential) B01: light smoothing B10: medium smoothing B11: heavy smoothing	R/W

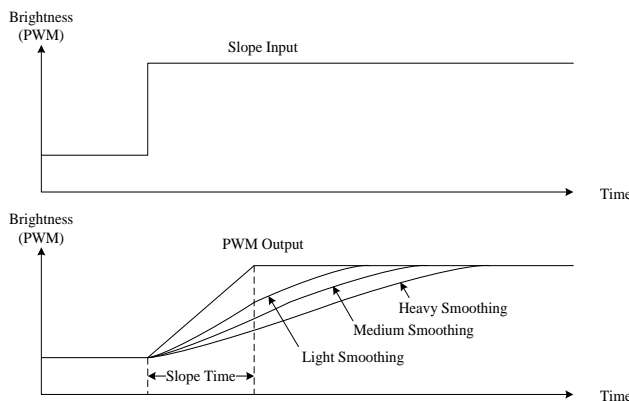

PWM Sample Rate

In DC/Mixed/Mixed-26kHz, the digital modulator need sample rate to calculate average current based on PWM input frequency. The user must set 0x07h [7:5] to coordinate sample rate for different PWM input frequencies. More setting details are shown in Table 13.

Table 13. PWM Sample Rate

Address	Bit	Name	Default Value	Description	R/W
07h	[7:5]	PWM sample rate	auto detection (B000)	B000: auto detection B001: 0.5MHz B010: 1MHz B011: 2MHz B100: 4MHz B101: 8MHz B110: 16MHz B111: 16MHz	R/W

Note :

PWM Input Frequency Range	PWM sample rate 07h[7:5]
PWM frequency fixed	B000 (auto detection)
$PWM \leq 61\text{Hz}$	B001 (0.5MHz)
$61\text{Hz} < PWM \leq 122\text{Hz}$	B010 (1MHz)
$122\text{Hz} < PWM \leq 244\text{Hz}$	B011 (2MHz)
$244\text{Hz} < PWM \leq 488\text{Hz}$	B100 (4MHz)
$488\text{Hz} < PWM \leq 977\text{Hz}$	B101 (8MHz)
$977\text{Hz} < PWM$	B110 (16MHz)
	B111 (16MHz)

Soft-Start Time Control

The RT4539 intergrades a soft-start time control to prevent brightness change suddenly during power-on. The soft-start time control can be set by the I²C interface. More setting details are shown in Table 14.

Table 14. Soft Start Time Control

Address	Bit	Name	Default Value	Description	Resolution	R/W
08h	[1:0]	Soft-Start Time Control	1 μ s (B00)	Soft start time control B00 : 1 μ s B01 : 16 μ s B10 : 128 μ s B11 : 512 μ s	--	R/W

Soft-start time can be controlled by address 0x08h [1:0]. There are four times to adjust range from 1 μ s to 512 μ s.

The soft-start time function is only enabled during power-on. When the Soft-start command is below B00, the brightness time of per step will be kept at 1 μ s. This function can guarantee the highest of Soft-start time is 512 μ s.

26KHz Mode Division Frequency

The 26KHz mode division frequency can be set by the I²C interface, as shown in Table 15.

Table 15. 26KHz Mode Division Frequency

Address	Bit	Name	Default Value	Description	Resolution	R/W
08h	[7:5]	26KHz mode division frequency	26KHz (B000)	PWMO frequency B000 : 26KHz B001 : 26KHz/2 B010 : 26KHz/4 B011 : 26KHz/8 B1xx : 26KHz/16	--	R/W

The 26kHz mode division frequency can be controlled by address 08h[7:5], there are five division frequencies including 26KHz, 26KHz/2, 26KHz/4, 26KHz/8 and 26KHz/16. Moreover, this function can only be used at PWM input control, if input control interface is I²C mode, the address 08h[7:5] must write B000.

Control CLK PFM Function Enable and Lowest Switching Frequency for PFM

The Boost converter integrates a PFM function for high efficiency at light load. This function can be enabled or disabled by address 0x09h [0:0]. Moreover, PFM frequency can be set to different values by the desirable applications. More setting details are shown in Table 16.

Table 16. Control CLK PFM Function Enable

Address	Bit	Name	Default Value	Description	R/W
09h	[0:0]	Control CLK PFM function enable	off (B0)	Control CLK PFM function enable B0 : Off B1 : On	R/W
	[6:1]	Lowest Switching Frequency for PFM	31.15KHz (0x3Ch)	Lowest switching frequency setting Formula: 16000/((16000/Fsw)+(8*Code)+7}	R/W

The CLK PFM function enable can be controlled by address 09h[0:0]. If the bit equals to 0, it means the boost switching frequency just depends on the switching frequency setting. Otherwise, if the bit equals to 1, the boost switching frequency will be decreased, when the boost on time is lower than the minimum on-time.

Protection

RT4539 embeds LED protection for LED OVP level, and Boost OVP. The LED protection can be set by the I²C, as shown in Table 17.

Table 17. Protection

Address	Bit	Name	Default Value	Description	R/W
0Ah	[4:0]	Boost Over-Voltage Protection selection	36V (0x1Ah)	Boost output over-voltage protection 0x00h to 0x1Eh : 10V~40V	R/W
	[6:5]	LED OVP Level	2.1V (B00)	LED OVP level B00: 2.1V B01: 2.52V B10: 2.8V B11: 3.5V	R/W
	[7:7]	LED Short Protection	Disable (B0)	LED Short Protection B0: Disable B1: Enable	R/W

When the Boost output voltage rises above the V_{OVP}, the internal switch will be turned off. Once the Boost output voltage drops below the V_{OVP}, the internal switch will be turned on again. The Boost output voltage can be clamped at the V_{OVP}.

Boost Over-voltage Protection selection [4:0]	Boost OVP (V)
0x00h	10
0x01h	11
0x02h	12
0x03h	13
0x04h	14
0x05h	15
0x06h	16
0x07h	17
0x08h	18
0x09h	19
0x0Ah	20
0x0Bh	21
0x0Ch	22
0x0Dh	23
0x0Eh	24
0x0Fh	25

Boost Over-voltage Protection selection [4:0]	Boost OVP (V)
0x10h	26
0x11h	27
0x12h	28
0x13h	29
0x14h	30
0x15h	31
0x16h	32
0x17h	33
0x18h	34
0x19h	35
0x1Ah	36
0x1Bh	37
0x1Ch	38
0x1Dh	39
0x1Eh	40
0x1Fh	40

Backlight Control

The backlight and/or FB channel can be enabled or disabled independently via address 0x0Bh register. If users desires to configure any functions, the BL_EN is recommended to write 0 by I²C interface. More setting details are shown in the following table.

Table 18

Address	Bit	Name	Default Value	Description	R/W
0Bh	[7]	BL_EN	Backlight enable (B1)	Enable backlight. B0: Backlight disabled (This selection is recommended for systems with an I ² C master. With an I ² C master, the backlight can be controlled by writing to the register 0Bh.) B1: Backlight enabled (This selection is recommended for systems with PWM-only control.)	R/W
	[6]	FB6_EN	ON (B1)	FB6 Enable B0: OFF B1: ON	R/W
	[5]	FB5_EN	ON (B1)	FB5 Enable B0: OFF B1: ON	R/W
	[4]	FB4_EN	ON (B1)	FB4 Enable B0: OFF B1: ON	R/W
	[3]	FB3_EN	ON (B1)	FB3 Enable B0: OFF B1: ON	R/W
	[2]	FB2_EN	ON (B1)	FB2 Enable B0: OFF B1: ON	R/W
	[1]	FB1_EN	ON (B1)	FB1 Enable B0: OFF B1: ON	R/W

MTP Function

The RT4539 integrates Multiple-Time Programmable (MTP) non-volatile memory. During power-on, the contents of the MTP are transferred to the DAC register. Users can write and read MTP or DAC via I2C interface. If users want to change data of MTP, it is needed to write all desired data to DAC first. Finally, write address 0xFFh [7:7] = 1, and it will write all data of DAC into MTP. Users also can read data from DAC or MTP via address 0xFFh [0:0]. When 0xFFh = 0, I2C interface reads data from DAC. Otherwise, 0xFFh = 1, I2C interface reads data from MTP. The detailed description is shown in Table 19.

Table 19. MTP Function

Address	Bit	Name	Default Value	Description	R/W
FFh	[0:0]	MTP Read	I ² C read data from DAC (B0)	MTP Read B0: I ² C reads data from DAC B1: I ² C reads data from MTP	R/W
FFh	[7:7]	MTP Programming	Normal operation (B0)	MTP Programming B0: Normal operation B1: Start MTP programming sequence	R/W

LED OVP level

The LED OVP level can be controlled by address 0x0Ah [6:5] and LED OVP level range is from 2.1V to 3.5V. When the minimum FBx voltage rises above the LED OVP level setting, the internal switch will be turned off. Once the minimum FBx voltage drops below the LED OVP level setting, the internal switch will be turned on again. The minimum FBx voltage can be clamped at the LED OVP level setting.

LED Connection

The LED strings are connected from the output of the boost converter to pin FBx (x = 1 to 6) respectively. If one of the current sink channels is not used, the FBx pin should be connected to GND. If the un-used channel is not connected to GND, it will be considered as a LED string open. Once the channel is accounted as string open, the un-used channel can be turned on again when the LED string is reconnected.

LED String Open Protection

If the voltage at FBx pin is lower than 100mV, this channel is defined as open channel. The Minimum LED Selection function will discard this channel and regulate other used channels in proper voltage. Once the channel is accounted as string open, the FBx pin voltage will not be regulated and not latched, until the FBx pin is reconnected, the FBx pin will work normally again. If all FBx pins are open (floating), the output voltage will be clamped to the setting voltage of OVP ($V_{OUT(OVP)}$).

LED String Short Protection

If CHx pin voltages exceeds the threshold of approximately 5.6V during normal operation, the channels will be turned off and it can be reset by EN or VIN UVLO.

Ove-Temperature Protection

The RT4539 has over-temperature protection function to prevent the IC from overheating due to excessive power dissipation. The OTP function will shut down the IC when junction temperature exceeds 150°C (typ.). When junction temperature cools down to 130°C ($T_{OTP_hys} = 20^\circ\text{C}$), the LED driver will return to normal operation.

Input Capacitor Selection

Low ESR ceramic capacitors are recommended for input capacitor applications. Low ESR will effectively reduce the input ripple voltage caused by the switching operation. Two 2.2μF low ESR ceramic capacitors are sufficient for most applications. Nevertheless, this value can be decreased for applications with lower output current requirement.

Another consideration is the voltage rating of the input capacitor, which must be greater than the maximum input voltage.

Boost Inductor Selection

The value of the inductance, L, can be approximated by the following equation, where the transition is from Discontinuous Conduction Mode (DCM) to Continuous Conduction Mode (CCM) :

$$L = \frac{D \times (1-D)^2 \times V_{OUT}}{2 \times f_{OSC} \times I_{OUT}}$$

The duty cycle, D, can be calculated by the following equation :

$$D = \frac{V_{OUT} - V_{IN}}{V_{OUT}}$$

Where V_{OUT} is the maximum output voltage, V_{IN} is the minimum input voltage, f_{osc} is the operating frequency, and I_{OUT} is the sum of current from all LED strings. The boost converter operates in DCM over the entire input voltage range when the inductor value is less than this value, L. With an inductance greater than L, the converter operates in CCM at the minimum input voltage and may be discontinuous at higher voltages. The inductor must be selected with a saturated current rating that is greater than the peak current as provided by the following equation :

$$I_{PEAK} = \frac{V_{OUT} \times I_{OUT}}{\eta \times V_{IN}} + \frac{V_{IN} \times D \times T_{OSC}}{2 \times L}$$

where η is the efficiency of the power converter.

Boost Diode Selection

The Schottky diode is a good choice for any asynchronous boost converter with its small forward voltage. However, when selecting a Schottky diode, important parameters such as power dissipation,

reverse voltage rating, and pulsating peak current must all be taken into consideration. A suitable Schottky diode's reverse voltage rating must be greater than the maximum output voltage, and its average current rating must exceed the average output current.

Boost Output Capacitor Selection

Output ripple voltage is an important index for estimating the performance. This portion consists of two parts, one is the product of IIN and ESR of output capacitor, the other part is formed by charging and discharging process of output capacitor. As shown in Figure 11, ΔVOUT1 can be evaluated based on the ideal energy equalization. According to the definition of Q, the Q value can be calculated by the following equation :

$$Q = \frac{1}{2} \times \left[\left(I_{IN} - \frac{1}{2} \Delta I_L - I_{OUT} \right) + \left(I_{IN} - \frac{1}{2} \Delta I_L - I_{OUT} \right) \right] \times \frac{V_{IN}}{V_{OUT}} \times \frac{1}{f_{OSC}} = C_{OUT} \times \Delta V_{OUT1}$$

where fOSC is the switching frequency and ΔIL is the inductor ripple current. Move COUT to the left side to estimate the value of ΔVOUT1 by the following equation :

$$\Delta V_{OUT1} = \frac{D \times I_{OUT}}{\eta \times C_{OUT} \times f_{OSC}}$$

Where D is the duty cycle and η is the boost converter efficiency. Finally, taking ESR into account, the overall output ripple voltage can be determined by the following equation :

$$\Delta V_{OUT} = \Delta V_{ESR} = \frac{D \times I_{OUT}}{\eta \times C_{OUT} \times f_{OSC}}$$

Where ΔVESR = ΔIC x RESR = IPEAK x RESR

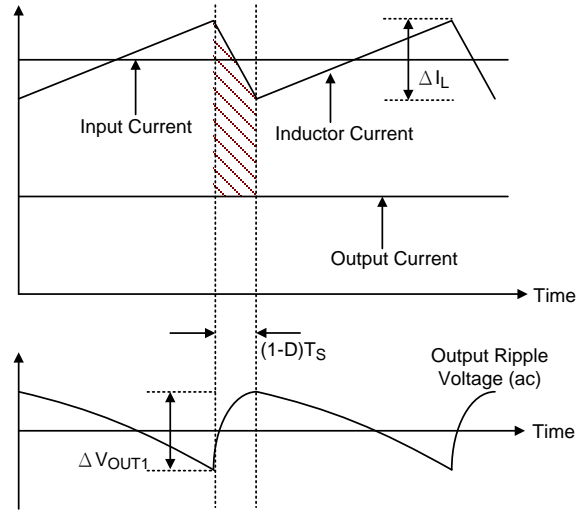

Figure 11. The output ripple voltage without the contribution of ESR

Peak Current Calculation in DCM

In general backlight applications the loading is not much at low dimming duty, therefore the boost converter usually operates in DCM. The peak current of through inductor (IL_peak) can be calculated by the following equation in DCM :

$$I_{L_peak} = \frac{V_{IN}}{L} D_{DCM} T_s$$

$$D_{DCM} = \sqrt{\frac{2L I_{OUT} (V_{OUT} - V_{IN}) \times f_s}{V_{IN}^2}}$$

Where DDCM is the duty cycle of the switch turn-on in DCM

Thermal Considerations

The junction temperature should never exceed the absolute maximum junction temperature TJ(MAX), listed under Absolute Maximum Ratings, to avoid permanent damage to the device. The maximum allowable power dissipation depends on the thermal resistance of the IC package, the PCB layout, the rate of surrounding airflow, and the difference between the junction and ambient temperatures. The maximum power dissipation can be calculated using the following formula :

$$P_{D(MAX)} = (T_{J(MAX)} - T_A) / \theta_{JA}$$

where TJ(MAX) is the maximum junction temperature,

T_A is the ambient temperature, and θ_{JA} is the junction-to-ambient thermal resistance.

For continuous operation, the maximum operating junction temperature indicated under Recommended Operating Conditions is 125°C. The junction-to-ambient thermal resistance, θ_{JA} , is highly package dependent. For a WL-CSP-20B 1.71x2.371 (BSC) package, the thermal resistance, θ_{JA} , is 33.1°C/W on a standard JEDEC 51-7 high effective-thermal-conductivity four-layer test board. The maximum power dissipation at $T_A = 25^\circ\text{C}$ can be calculated as below :

$$P_{D(\text{MAX})} = (125^\circ\text{C} - 25^\circ\text{C}) / (33.1^\circ\text{C}/\text{W}) = 3.02\text{W for a WL-CSP-20B 1.71x2.371 (BSC) package.}$$

The maximum power dissipation depends on the operating ambient temperature for the fixed $T_{J(\text{MAX})}$ and the thermal resistance, θ_{JA} . The derating curves in Figure 12 allows the designer to see the effect of rising ambient temperature on the maximum power dissipation.

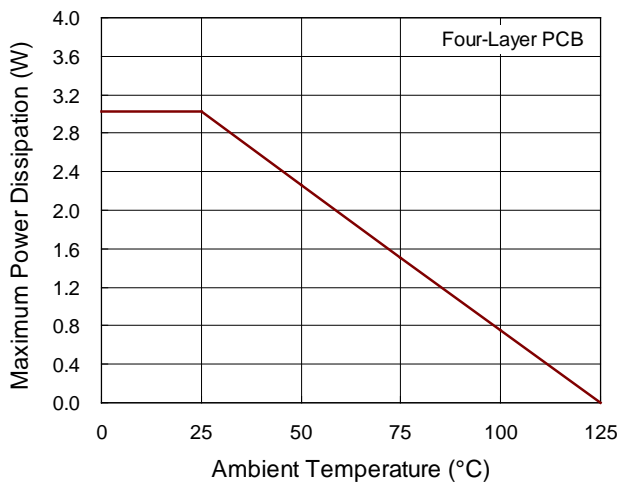

Figure 12. Derating Curve of Maximum Power Dissipation

Layout Consideration

- ▶ For good regulation, place the power components as close to the IC as possible. The traces should be wide and short, especially for the high current output loop.
- ▶ The input and output bypass capacitor should be placed as close to the IC as possible and connected to the ground plane of the PCB.
- ▶ Minimize the size of the L nodes and keep traces wide and short. Care should be taken to avoid running traces that carry any noise-sensitive signals near LX or high-current traces.
- ▶ Separate power ground (PGND) and ground (GND). Connect the GND and the PGND islands at a single end. Make sure that there are no other connections between these separate ground planes.
- ▶ Connect the exposed pad to a strong ground plane for maximum thermal dissipation.

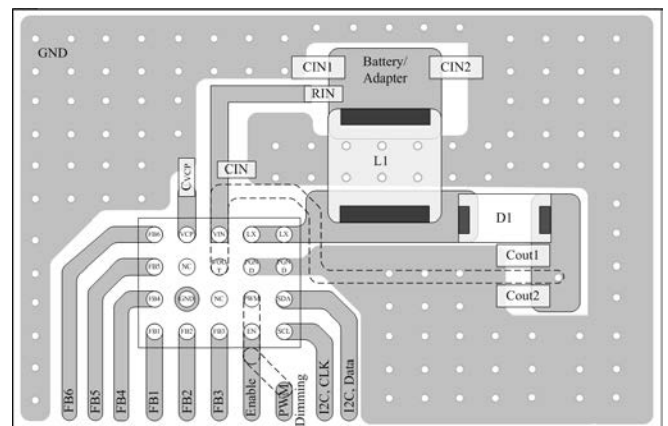
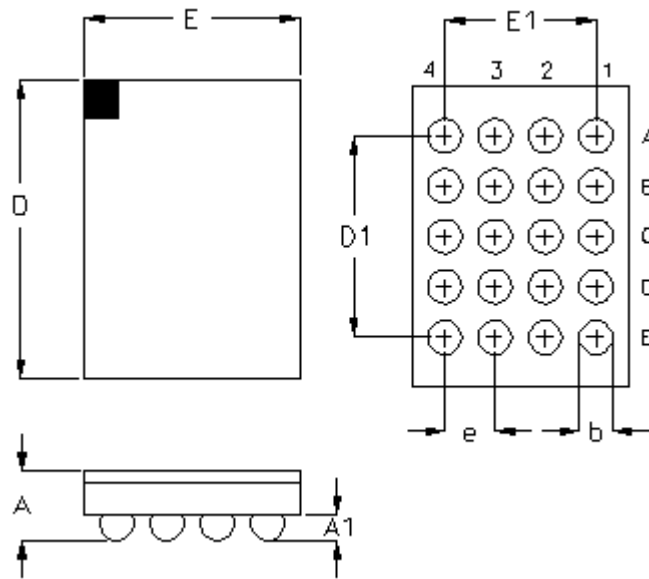

Figure 13. PCB Layout Guide

Outline Dimension



Symbol	Dimensions In Millimeters		Dimensions In Inches	
	Min	Max	Min	Max
A	0.500	0.600	0.020	0.024
A1	0.170	0.230	0.007	0.009
b	0.240	0.300	0.009	0.012
D	2.341	2.401	0.092	0.095
D1	1.600		0.063	
E	1.680	1.740	0.066	0.069
E1	1.200		0.047	
e	0.400		0.016	

20B WL-CSP 1.71x2.371 Package (BSC)

Footprint Information

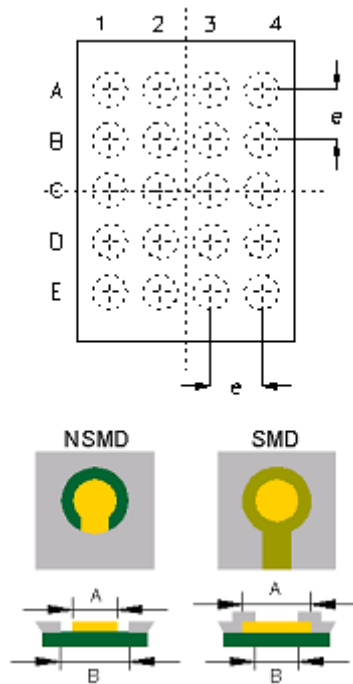

Package	Number of Pin	Type	Footprint Dimension (mm)			Tolerance
			e	A	B	
WL-CSP1.71x2.371-20(BSC)	20	NSMD	0.400	0.240	0.340	±0.025
		SMD		0.270	0.240	

Richtek Technology Corporation

14F, No. 8, Tai Yuen 1st Street, Chupei City
 Hsinchu, Taiwan, R.O.C.
 Tel: (8863)5526789

Richtek products are sold by description only. Richtek reserves the right to change the circuitry and/or specifications without notice at any time. Customers should obtain the latest relevant information and data sheets before placing orders and should verify that such information is current and complete. Richtek cannot assume responsibility for use of any circuitry other than circuitry entirely embodied in a Richtek product. Information furnished by Richtek is believed to be accurate and reliable. However, no responsibility is assumed by Richtek or its subsidiaries for its use; nor for any infringements of patents or other rights of third parties which may result from its use. No license is granted by implication or otherwise under any patent or patent rights of Richtek or its subsidiaries.

Mouser Electronics

Authorized Distributor

Click to View Pricing, Inventory, Delivery & Lifecycle Information:

[Richtek:](#)

[RT4539WSC](#)