

SMD ▪ PLCC EAPL3020WA1



Features

- PLCC-2 package
- Top view white LED
- High luminous intensity output
- Wide viewing angle
- Pb-free
- RoHS compliant
- ANSI Binning

Description

The Everlight EAPL3020WA1 package has high efficacy, high CRI, low power consumption, wide viewing angle and a compact form factor. These features make this package an ideal LED for all lighting applications.

Applications

- General lighting
- Decorative and Entertainment Lighting
- Indicators
- Illumination
- Switch lights

Mass Production List

Product	CRI Min. (1)	CCT(K)	Φ (lm) Min. (2)	Φ (lm) Max. (2)
EAPL3020WA1	80	3000K	17	24

Notes:

1. Tolerance of Color Rendering Index: ± 2
2. Tolerance of Luminous flux: $\pm 11\%$.

Device Selection Guide

Chip Materials	Emitted Color	Resin Color
InGaN	Cool White Neutral White Warm White	Water Clear

Absolute Maximum Ratings ($T_{\text{Soldering}}=25^{\circ}\text{C}$)

Parameter	Symbol	Rating	Unit
Forward Current	I_F	75	mA
Peak Forward Current (Duty 1/10 @10ms)	I_{FP}	100	mA
Power Dissipation	P_d	270	mW
Operating Temperature	T_{opr}	-40 ~ +85	$^{\circ}\text{C}$
Storage Temperature	T_{stg}	-40 ~ +100	$^{\circ}\text{C}$
Thermal Resistance (Junction / Soldering point)	$R_{th J-S}$	50	$^{\circ}\text{C/W}$
Junction Temperature	T_j	125	$^{\circ}\text{C}$
Soldering Temperature	T_{sol}	Reflow Soldering : 260 $^{\circ}\text{C}$ for 10 sec. Hand Soldering : 350 $^{\circ}\text{C}$ for 3 sec.	

Note:

The products are sensitive to static electricity and must be carefully taken when handling products

Electro-Optical Characteristics ($T_{\text{Soldering}}=25^{\circ}\text{C}$)

Parameter	Symbol	Min.	Typ.	Max.	Unit	Condition
Luminous Flux ₍₁₎	Φ	17	-----	24	lm	$I_F=60\text{mA}$
Forward Voltage ₍₂₎	V_F	2.9	-----	3.6	V	$I_F=60\text{mA}$
Color Rendering Index ₍₃₎	Ra	80	-----	-----		$I_F=60\text{mA}$
Viewing Angle	$2\theta_{1/2}$	-----	120	-----	deg	$I_F=60\text{mA}$
Reverse Current	I_R	-----	-----	50	μA	$V_R=5\text{V}$

Notes:

1. Tolerance of Luminous flux: $\pm 11\%$.
2. Tolerance of Forward Voltage: $\pm 0.1\text{V}$.
3. Tolerance of Color Rendering Index: ± 2

Bin Range of Luminous Flux

Bin Code	Min.	Max.	Unit	Condition
L8	17	18	lm	I _F =60mA
L9	18	19		
M3	19	21		
M4	21	24		

Note:
Tolerance of Luminous flux: ±11%.

Bin Range of Forward Voltage

Bin Code	Min.	Max.	Unit	Condition
36	2.9	3.0	V	I _F =60mA
37	3.0	3.1		
38	3.1	3.2		
39	3.2	3.3		
40	3.3	3.4		
41	3.4	3.5		
42	3.5	3.6		

Note:
Tolerance of Forward Voltage: ±0.1V.

The C.I.E. 1931 Chromaticity Diagram

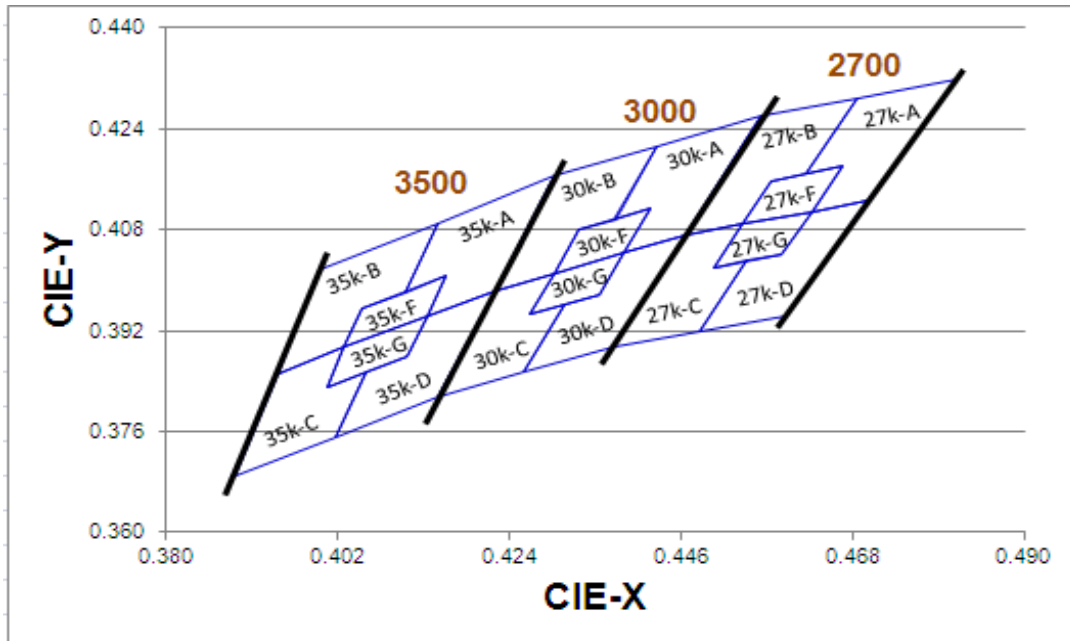

Bin Range of Chromaticity Coordinates

CCT	Bin Code	CIE_x	CIE_y	Bin Code	CIE_x	CIE_y	
2700K	27K-A	0.4813	0.4319	27K-D	0.4700	0.4126	
		0.4687	0.4289		0.4627	0.4109	
		0.4621	0.4169		0.4588	0.4041	
		0.4667	0.4180		0.4544	0.4030	
		0.4627	0.4109		0.4483	0.3919	
		0.4700	0.4126		0.4593	0.3944	
	Reference Range:2580K~2700K						
	27K-B	0.4687	0.4289	27K-C	0.4465	0.4071	
		0.4562	0.4260		0.4373	0.3893	
		0.4465	0.4071		0.4483	0.3919	
		0.4539	0.4088		0.4544	0.4030	
		0.4576	0.4158		0.4502	0.4020	
		0.4621	0.4169		0.4539	0.4088	
	Reference Range:2700K~2870K						
	27K-F	0.4667	0.4180	27K-G	0.4627	0.4109	
		0.4576	0.4158		0.4539	0.4088	
		0.4539	0.4088		0.4502	0.4020	
		0.4627	0.4109		0.4588	0.4041	
Reference Range: 2665K~2770K							

CCT	Bin Code	CIE_x	CIE_y	Bin Code	CIE_x	CIE_y	
3000K	30K-A	0.4562	0.4260	30K-D	0.4465	0.4071	
		0.4430	0.4212		0.4388	0.4043	
		0.4375	0.4096		0.4355	0.3977	
		0.4422	0.4113		0.4311	0.3962	
		0.4388	0.4043		0.4259	0.3853	
		0.4465	0.4071		0.4373	0.3893	
	Reference Range:2870K~3000K						
	30K-B	0.4430	0.4212	30K-C	0.4221	0.3984	
		0.4299	0.4165		0.4147	0.3814	
		0.4221	0.3984		0.4259	0.3853	
		0.4297	0.4011		0.4311	0.3962	
		0.4328	0.4079		0.4267	0.3946	
		0.4375	0.4096		0.4297	0.4011	
	Reference Range:3000K~3220K						
	30K-F	0.4422	0.4113	30K-G	0.4388	0.4043	
		0.4328	0.4079		0.4297	0.4011	
		0.4297	0.4011		0.4267	0.3946	
		0.4388	0.4043		0.4355	0.3977	
	Reference Range:2960K~3080K						

CCT	Bin Code	CIE_x	CIE_y	Bin Code	CIE_x	CIE_y	
3500K	35K-A	0.4299	0.4165	35K-D	0.4221	0.3984	
		0.4148	0.4090		0.4134	0.3943	
		0.4106	0.3981		0.4108	0.3878	
		0.4159	0.4007		0.4057	0.3853	
		0.4134	0.3943		0.4018	0.3752	
		0.4221	0.3984		0.4147	0.3814	
	Reference Range:3220K~3500K						
	35K-B	0.4148	0.4090	35K-C	0.3943	0.3853	
		0.3996	0.4015		0.3889	0.3690	
		0.3943	0.3853		0.4018	0.3752	
		0.4029	0.3893		0.4057	0.3853	
		0.4051	0.3954		0.4006	0.3829	
		0.4106	0.3981		0.4029	0.3893	
	Reference Range:3500K~3710K						
	35K-F	0.4159	0.4007	35K-G	0.4134	0.3943	
		0.4051	0.3954		0.4029	0.3893	
		0.4029	0.3893		0.4006	0.3829	
		0.4134	0.3943		0.4108	0.3878	
	Reference Range:3360K~3540K						

The C.I.E. 1931 Chromaticity Diagram

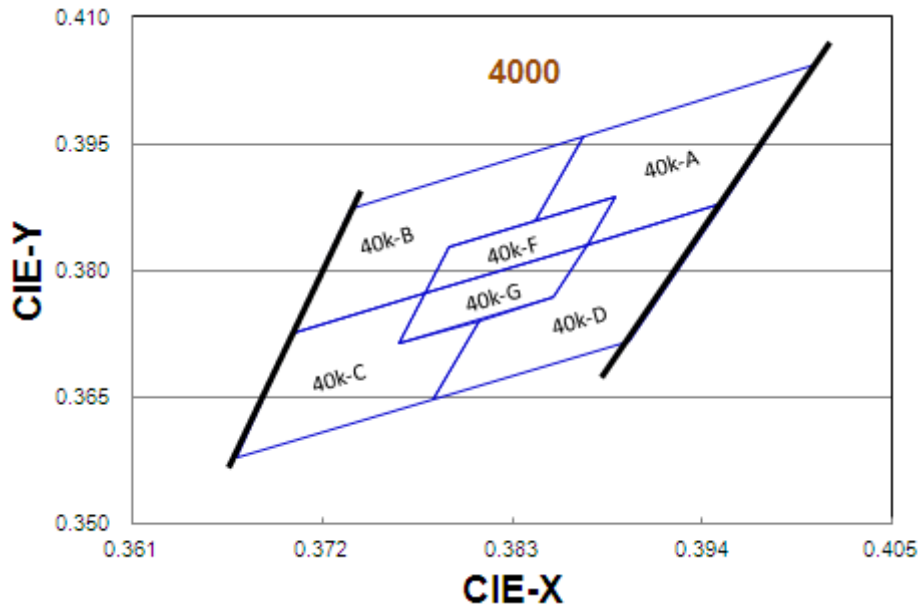

Bin Range of Chromaticity Coordinates

CCT	Bin Code	CIE_x	CIE_y	Bin Code	CIE_x	CIE_y	
4000K	40K-A	0.4006	0.4044	40K-D	0.3952	0.3880	
		0.3871	0.3959		0.3873	0.3831	
		0.3843	0.3858		0.3854	0.3768	
		0.3890	0.3887		0.3810	0.3741	
		0.3873	0.3831		0.3784	0.3647	
		0.3952	0.3880		0.3898	0.3716	
	Reference Range:3700K~3970K						
	40K-B	0.3871	0.3959	40K-C	0.3703	0.3726	
		0.3736	0.3874		0.3670	0.3578	
		0.3703	0.3726		0.3784	0.3647	
		0.3779	0.3773		0.3810	0.3741	
		0.3793	0.3828		0.3764	0.3713	
		0.3843	0.3858		0.3779	0.3773	
	Reference Range:3970K~4270K						
	40K-F	0.3890	0.3887	40K-G	0.3873	0.3831	
		0.3793	0.3828		0.3779	0.3773	
		0.3779	0.3773		0.3764	0.3713	
		0.3873	0.3831		0.3854	0.3768	
	Reference Range:3870K~4080K						

The C.I.E. 1931 Chromaticity Diagram

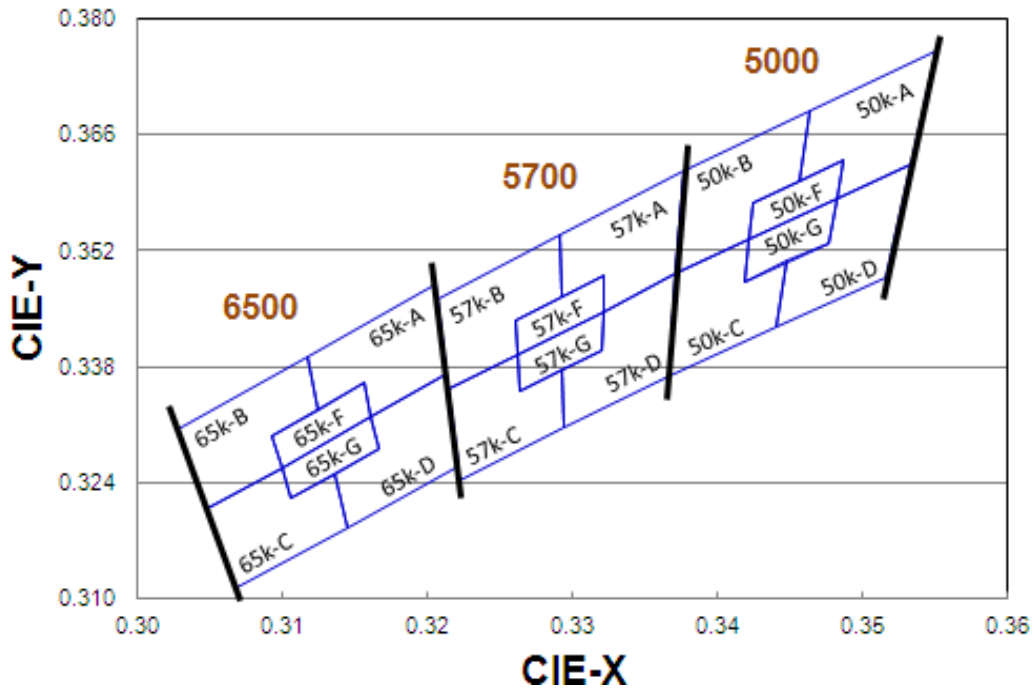

Bin Range of Chromaticity Coordinates

CCT	Bin Code	CIE_x	CIE_y	Bin Code	CIE_x	CIE_y	
5000K	50K-A	0.3551	0.3760	50K-D	0.3533	0.3624	
		0.3464	0.3688		0.3482	0.3583	
		0.3456	0.3604		0.3477	0.3530	
		0.3487	0.3629		0.3448	0.3507	
		0.3482	0.3583		0.3441	0.3428	
		0.3533	0.3624		0.3515	0.3487	
	Reference Range:4745K~5000K						
	50K-B	0.3464	0.3688	50K-C	0.3371	0.3493	
		0.3376	0.3616		0.3366	0.3369	
		0.3371	0.3493		0.3441	0.3428	
		0.3422	0.3533		0.3448	0.3507	
		0.3425	0.3579		0.3418	0.3483	
		0.3456	0.3604		0.3422	0.3533	
	Reference Range:5000K~5310K						
	50K-F	0.3487	0.3629	50K-G	0.3482	0.3583	
		0.3425	0.3579		0.3422	0.3533	
		0.3422	0.3533		0.3418	0.3483	
		0.3482	0.3583		0.3477	0.3530	
Reference Range:4910K~5120K							

CCT	Bin Code	CIE_x	CIE_y	Bin Code	CIE_x	CIE_y	
5700K	57K-A	0.3376	0.3616	57K-D	0.3371	0.3493	
		0.3292	0.3539		0.3321	0.3447	
		0.3292	0.3464		0.3320	0.3401	
		0.3321	0.3490		0.3293	0.3377	
		0.3321	0.3447		0.3294	0.3306	
		0.3371	0.3493		0.3366	0.3369	
	Reference Range:5310K~5700K						
	57K-B	0.3292	0.3539	57K-C	0.3215	0.3353	
		0.3207	0.3462		0.3222	0.3243	
		0.3215	0.3353		0.3294	0.3306	
		0.3262	0.3395		0.3293	0.3377	
		0.3261	0.3436		0.3263	0.335	
		0.3292	0.3464		0.3262	0.3395	
	Reference Range:5700K~6020K						
	57K-F	0.3321	0.3490	57K-G	0.3321	0.3447	
		0.3261	0.3436		0.3262	0.3395	
		0.3262	0.3395		0.3263	0.3350	
		0.3321	0.3447		0.3320	0.3401	
	Reference Range:5520K~5780K						

CCT	Bin Code	CIE_x	CIE_y	Bin Code	CIE_x	CIE_y	
6500K	65K-A	0.3205	0.3481	65K-D	0.3213	0.3371	
		0.3117	0.3393		0.3161	0.3320	
		0.3125	0.3328		0.3166	0.3281	
		0.3157	0.3360		0.3136	0.3251	
		0.3161	0.3320		0.3145	0.3187	
		0.3213	0.3371		0.3221	0.3261	
	Reference Range:6020K~6500K						
	65K-B	0.3117	0.3393	65K-C	0.3048	0.3209	
		0.3028	0.3304		0.3068	0.3113	
		0.3048	0.3209		0.3145	0.3187	
		0.3100	0.3259		0.3136	0.3251	
		0.3093	0.3297		0.3106	0.3222	
		0.3125	0.3328		0.31	0.3259	
	Reference Range:6500K~7050K						
	65K-F	0.3157	0.3360	65K-G	0.3161	0.3320	
		0.3093	0.3297		0.3100	0.3259	
		0.3100	0.3259		0.3106	0.3222	
		0.3161	0.3320		0.3166	0.3281	
	Reference Range:6300K~6690K						

Notes:

1. The value is based on driving current by 60mA.
2. Tolerance of Chromaticity Coordinates: ± 0.01 .

Spectrum Distribution

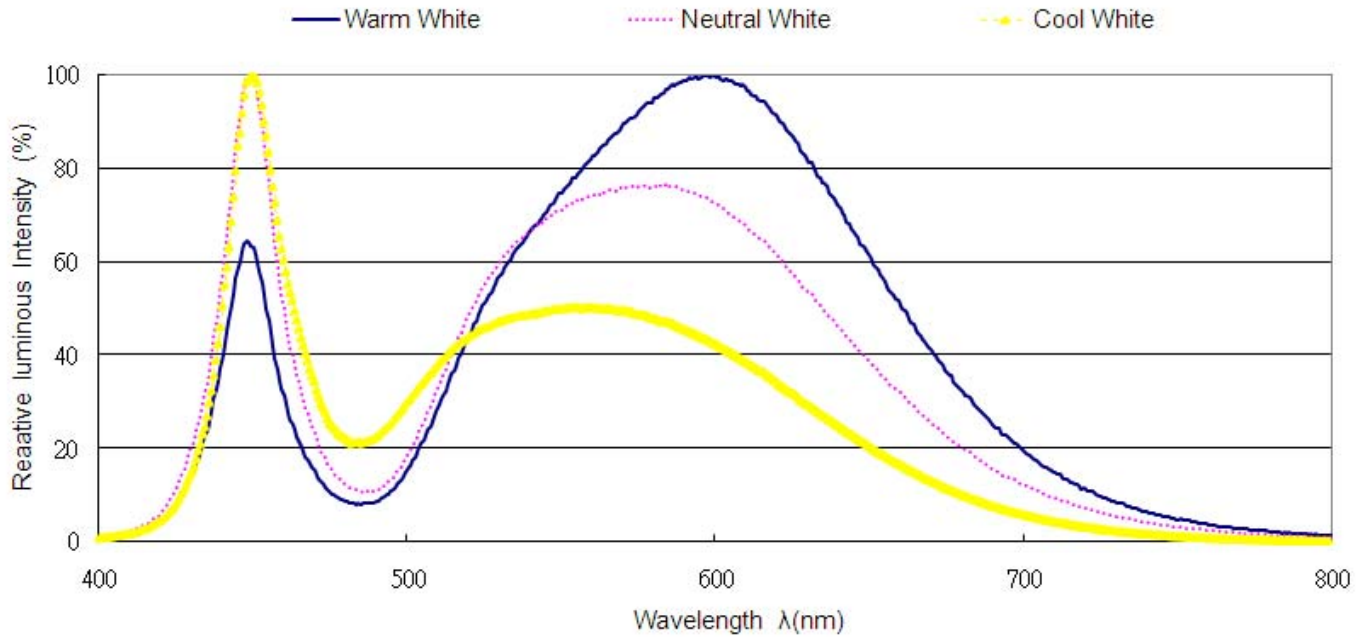

Typical Electro-Optical Characteristics Curves

Fig.1 – Forward Voltage Shift vs. Junction Temperature

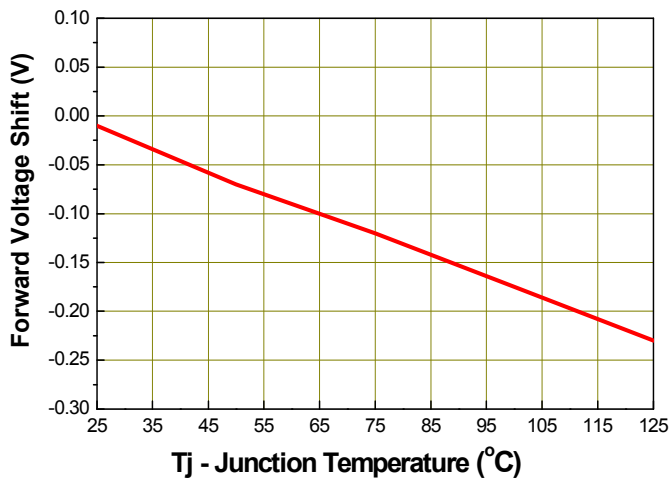
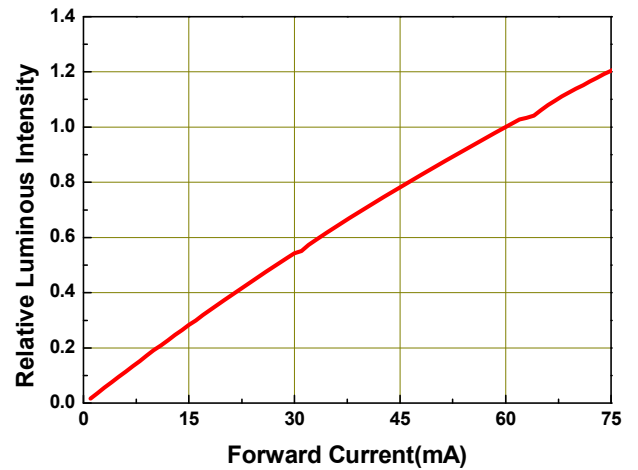

Fig.2 - Relative Luminous Intensity vs. Forward Current



Typical Electro-Optical Characteristics Curves

Fig.3 - Relative Luminous Intensity vs. Junction Temperature

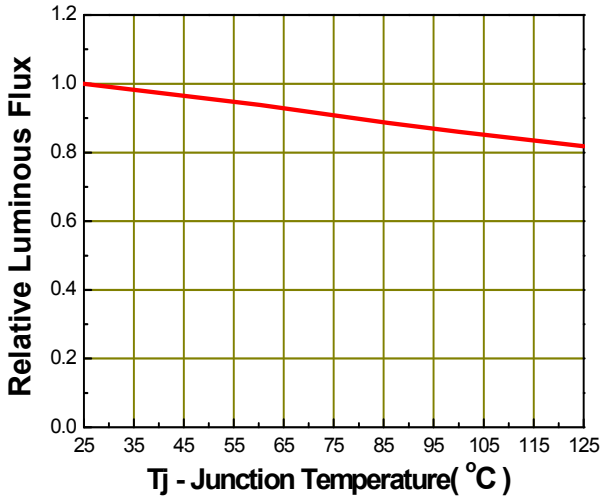

Fig.4 - Forward Current vs. Forward Voltage

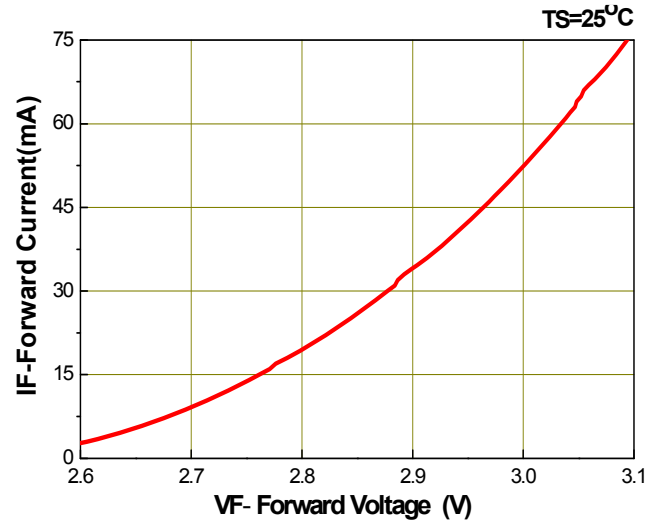

Fig.5 – Max. Driving Forward Current vs. Soldering Temperature

R_{th j-s}=50 ° C/W

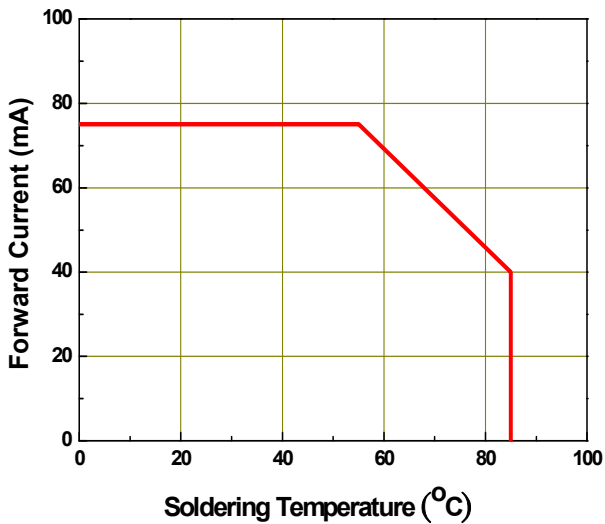
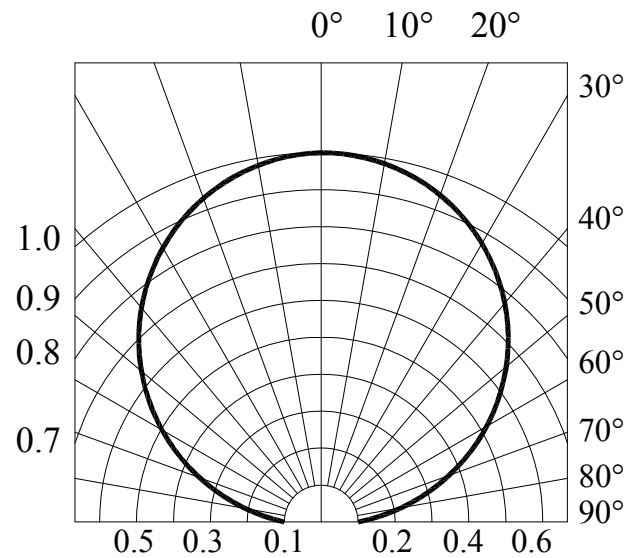
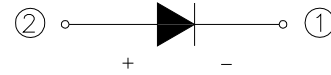
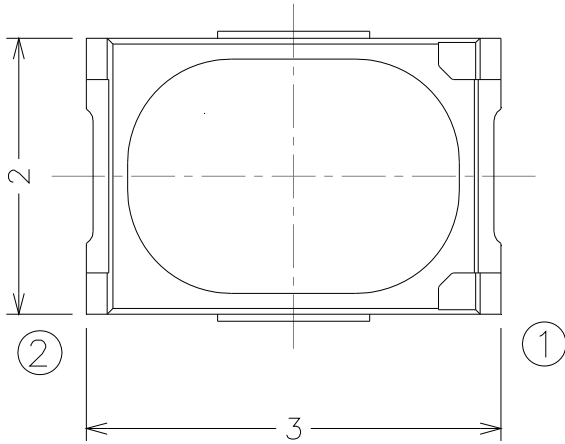

Fig.6 – Radiation Diagram



Package Dimension



Polarity

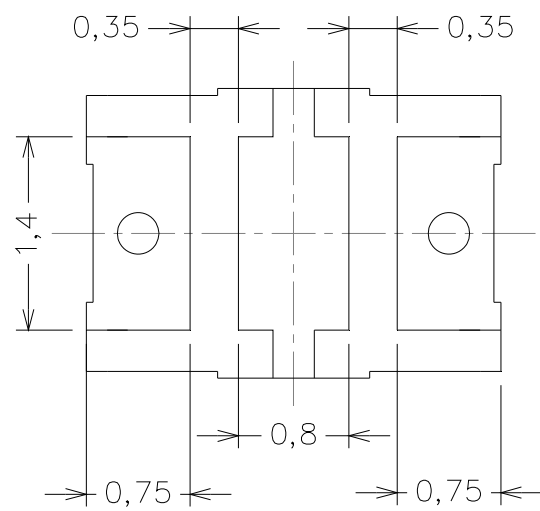
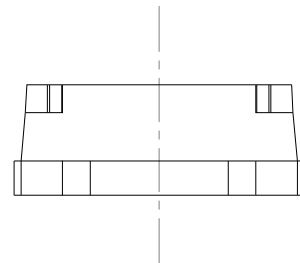
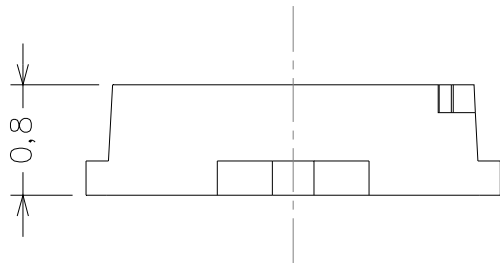

Bot. view

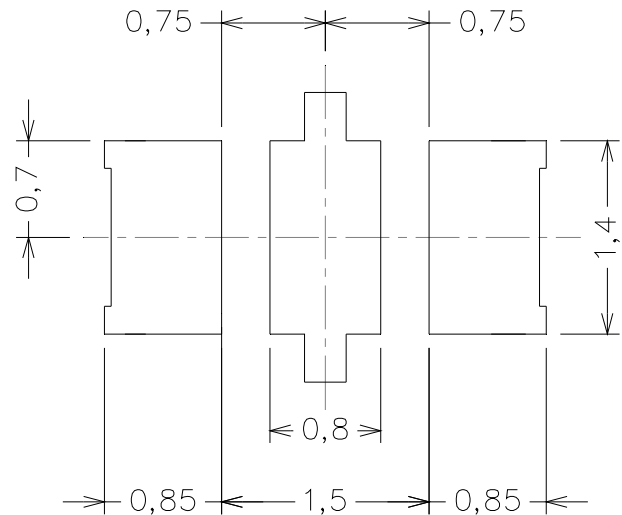

Soldering patterns

Note:
Tolerance unless mentioned is ± 0.15 mm; Unit = mm

Moisture Resistant Packing Materials

Label Explanation



- CPN: Customer's Product Number
- P/N: Product Number
- QTY: Packing Quantity
- CAT: Luminous Intensity Rank
- HUE: Dom. Wavelength Rank
- REF: Forward Voltage Rank
- LOT No: Lot Number

Reel Dimensions

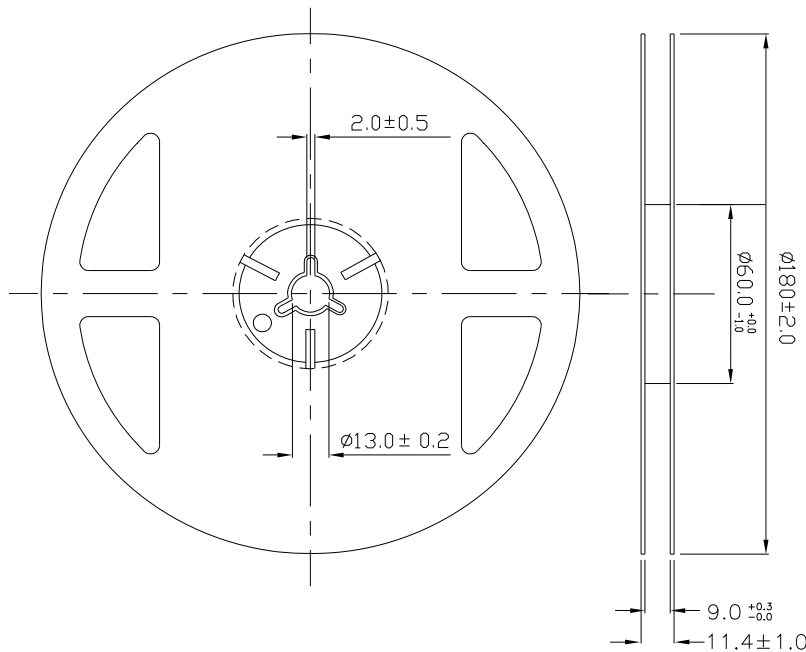

Note:
Tolerances unless mentioned ± 0.1 mm. Unit = mm

Carrier Tape Dimensions: Loaded Quantity 2000 pcs Per Reel

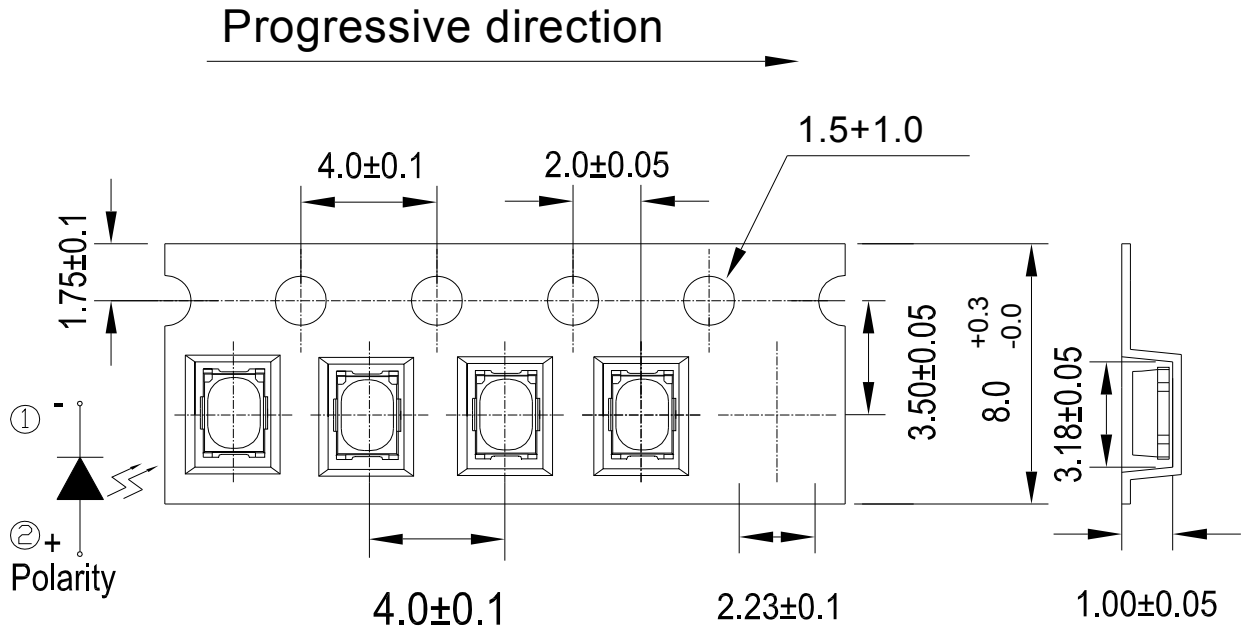

Note:
1. Tolerance unless mentioned is ± 0.1 mm; Unit = mm

Moisture Resistant Packing Process

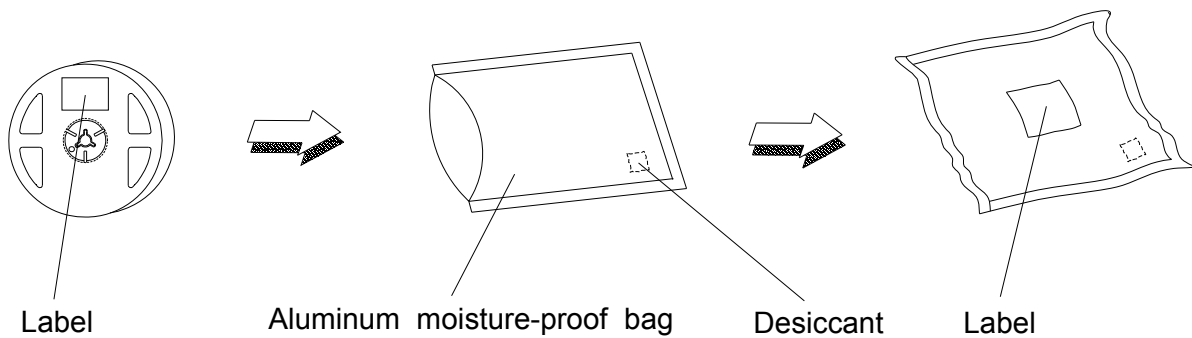

Reliability Test Items and Conditions

The reliability of products shall be satisfied with items listed below.
Confidence level : 90%
LTPD : 10%

No.	Items	Test Condition	Test Hours/Cycles	Sample Size	Ac/Re
1	Reflow Soldering	Temp. : 260°C/10sec.	6 Min.	22 PCS.	0/1
2	Thermal Shock	H : +100°C 20min ∫ 10 sec L : -10°C 20min	200 Cycles	22 PCS.	0/1
3	Temperature Cycle	H : +100°C 30min ∫ 5 min L : -40°C 30min	200 Cycles	22 PCS.	0/1
4	High Temperature/Humidity Reverse Bias	Ta=85°C,85%RH	1000 Hrs.	22 PCS.	0/1
5	High Temperature/Humidity Operation	Ta=85°C,85%RH, I _F = 40 mA	1000 Hrs.	22 PCS.	0/1
6	Low Temperature Storage	Ta=-40°C	1000 Hrs.	22 PCS.	0/1
7	High Temperature Storage	Ta=85°C	1000 Hrs.	22 PCS.	0/1
8	Low Temperature Operation Life	Ta=-40°C, I _F = 75 mA	1000 Hrs.	22 PCS.	0/1
9	High Temperature Operation/ Life#1	Ta=25°C, I _F = 75 mA	1000 Hrs.	22 PCS.	0/1
10	High Temperature Operation/ Life#2	Ta=55°C, I _F =75 mA	1000 Hrs.	22 PCS.	0/1
11	High Temperature Operation/ Life#3	Ta=85°C, I _F = 40 mA	1000 Hrs.	22 PCS.	0/1

Precautions for Use

1. Over-current-proof

Customer must apply resistors for protection; otherwise slight voltage shift will cause big current change (Burn out will happen).

2. Storage

2.1 Do not open moisture proof bag before the products are ready to use.

2.2 Before opening the package: The LEDs should be kept at 30°C or less and 90%RH or less.

2.3 After opening the package: The LED's floor life is 168 Hrs under 30°C or less and 60% RH or less. If unused LEDs remain, it should be stored in moisture proof packages.

2.4 If the moisture absorbent material (silica gel) has faded away or the LEDs have exceeded the storage time, baking treatment should be performed using the following conditions.

Baking treatment: 60±5°C for 24 hours.

3. Soldering Condition

3.1 Pb-free solder temperature profile

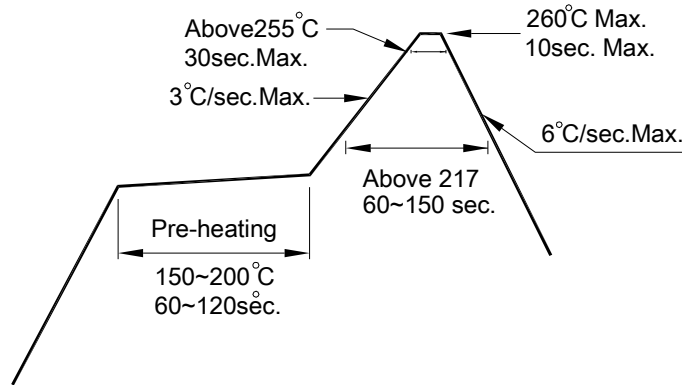

3.2 Reflow soldering should not be done more than two times.

3.3 When soldering, do not put stress on the LEDs during heating.

3.4 After soldering, do not warp the circuit board.

4. Soldering Iron

Each terminal is to go to the tip of soldering iron temperature less than 350°C for 3 seconds within once in less than the soldering iron capacity 25W. Leave two seconds and more intervals, and do soldering of each terminal. Be careful because the damage of the product is often started at the time of the hand solder.

5. Repairing

Repair should not be done after the LEDs have been soldered. When repairing is unavoidable, a double-head soldering iron should be used (as below figure). It should be confirmed beforehand whether the characteristics of the LEDs will or will not be damaged by repairing.

