

# EA DIP128-6

## LCD-GRAFIC MODULE 128x64 DOTS

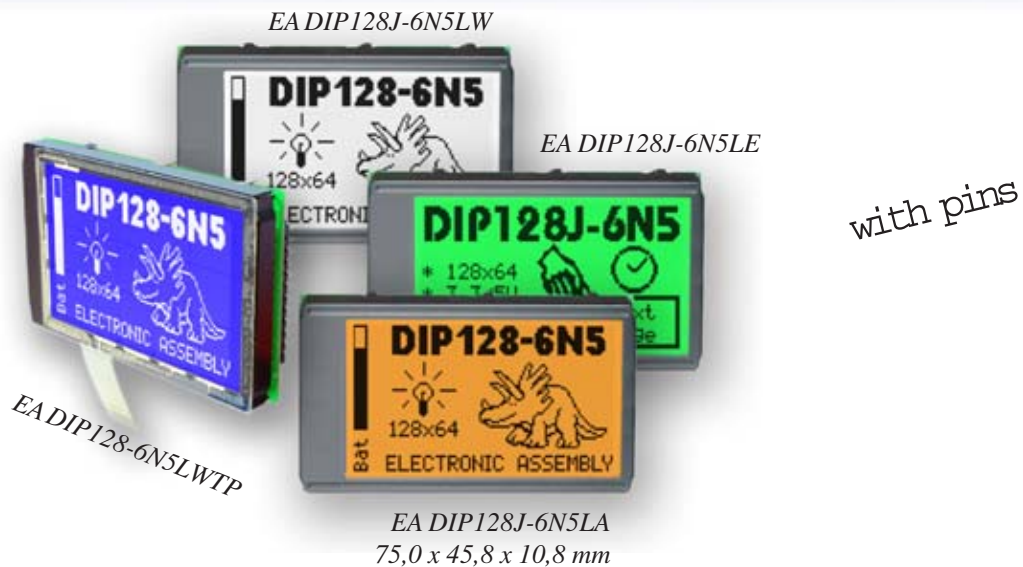

### FEATURES

- \* REAL BRIGHT AND CONTRASTY GRAPHIC DISPLAYS
- \* EA DIP128-6N5LW: WHITE DOTS, BLUE BACKGROUND
- \* EA DIP128J-6N5LW: BLACK DOTS, WHITE BACKGROUND
- \* WITH AMBER BACKLIGHT (LONGLIFE)
- \* GREEN VERSION FOR HIGHEST CONTRAST
- \* LOW-POWER LED BACKLIGHT min. 15mA, max. 90mA@+25°C
- \* INTEGRATED CONTROLLER KS0107/108 OR PT6607/08
- \* TEMPERATURE COMPENSATION BUILT-IN
- \* 8-BIT BUS INTERFACE
- \* NO MOUNTING REQUIRED: JUST SOLDER INTO PCB
- \* POWER SUPPLY +5V
- \* OPERATING TEMPERATURE RANGE -20°C..+70°C

### ACCESSORIES

- \* MATRIX TOUCH PANEL 5x3, ANTIGLARE AND SCRATCH-PROOF
- \* HIGH-LEVEL-GRAPHICS-CONTROLLER FOR RS-232: **EA IC202-PGH**

### ORDERING INFORMATION

LCD GRAPHIC MODULE 128x64 DOTS BLUE-WHITE  
 SAME BUT IN BLACK/WHITE OPTIC  
 WITH AMBER BACKLIGHT  
 WITH GREEN BACKLIGHT  
 ALL WITH TOUCH PANEL, 5x3 FIELDS  
 SOCKET 4.5mm HEIGHT, 12 PINS (1 pc.)  
 ZIFF CONNECTOR (SMD) FOR TOUCH PANEL

**EA DIP128-6N5LW**  
**EA DIP128J-6N5LW**  
**EA DIP128J-6N5LA**  
**EA DIP128J-6N5LE**  
**EA DIP128x-xxxxxTP**  
**EA B254-12**  
**EA WF100-10S**

**ELECTRONIC  
 ASSEMBLY**  
 making things easy

## PINOUT

Pin	Symbol	Function	Pin	Symbol	Function
1	VSS	Power Supply 0V (GND)	13	VNEG	neg. voltage output f. contrast
2	VDD	Power Supply +5V	14	NC	not connected
3	ADJ	Contrast adjustment	15	D0	Display Data, LSB
4	RES	L: Reset	16	D1	Display Data
5	D/I	H=Data; L=Command	17	D2	Display Data
6	R/W	H=Read, L=Write	18	D3	Display Data
7	E1	Enable left half of display	19	D4	Display Data
8	E2	Enable right half of display	20	D5	Display Data
9	CS1L	L: Chipselect left, low active	21	D6	Display Data
10	CS1H	H: Chipselect left, high active	22	D7	Display Data, MSB
11	CS2L	L: Chipselect right, low active	23	A	LED + (ext. series resistor !)
12	CS2H	H: Chipselect right, high active	24	C	LED -

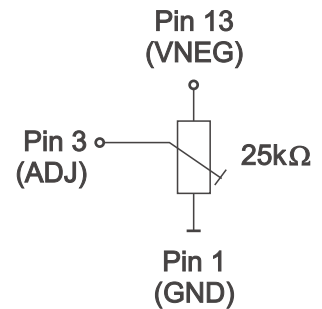

## CONTRAST

is already adjusted for 5V when shipped out. Once contrast is set to an optimum, internal temperature compensation circuit provides best contrast allover the whole temperature range of -20..+70°C. An external contrast adjustment is normally not necessary, but can be done via external potentiometer.

## BACKLIGHT

Graphic displays EA DIP128-6 are featured with a low-power LED-backlight. Brightness can be switched off and adjusted infinitely.

Driving the LED backlight requires a current source or an external series resistor for current limiting. Forward voltage is between 2.2..2.6V (amber), 3.9..3.6V (white), 3.7..4.1V (green). Maximum supply current is 90mA@+25°C. Operating with 5V we recommend a limiting resistor for amber of 12 Ohm, for the white one of 24 Ohm and for the green one of 15 Ohm. Please take care of derating when used at  $t_a > +25^\circ\text{C}$ .

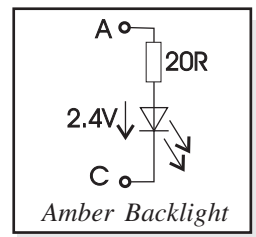

**Attention:** Do never drive backlight direct to 5V; this may cause immediately defect !

**Note:** Blue-white version provide no contrast when backlight is switched off. Reading the display requires a minimum of backlight with about 15mA.

## BLACK&WHITE, BLUE, AMBER, GREEN

The blue-white display EA DIP128-6N5LW is best for indoor use with and without ambient light. Reading the display requires a minimum of backlight with about 15mA.

Black and white version EA DIP128J-6N5LW and green version are especially designed for outdoor applications. These displays do provide best contrast for all ambient illuminations, even with direct sunlight. No need to say that display can be read in darkness when LED backlight is switched on.

This is same for the amber backlighted version EA DIP128J-6N5LA. The greatest advantage here is the long life backlight.

## APPLICATION EXAMPLES

Besides you can see some application examples.

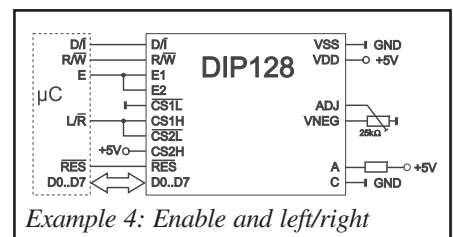
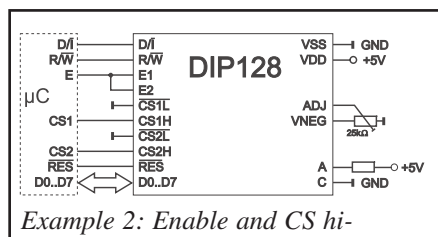
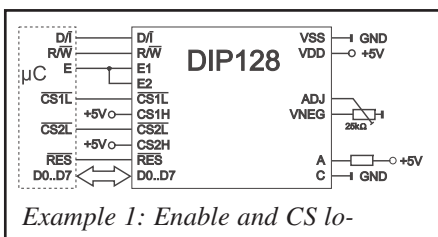
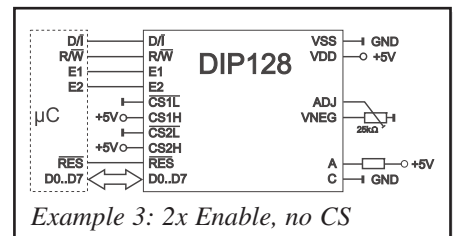

**BLOCK DIAGRAM**



**ABSOLUTE MAXIMUM RATING**

Parameter	Symbol	Min	Max	Unit
Power supply for logic	VDD-VSS	0	7,0	V
Input voltage	VI	VSS	VDD	V
Operating temperature	Ta	-20	+70	°C
Storage temperature	Tstg	-30	+80	°C

**TIMING CHARACTERISTICS** (T<sub>a</sub> = -20..+70°C)

Parameter	Symbol	Min	Typ	Max	Unit
Enable cycle time	tcyc	1000	-	-	ns
Enable Puls width	tWEH	450	-	-	ns
	tWEL	450	-	-	ns
Enable raise time	tEr	-	-	25	ns
Enable fall time	tEf	-	-	25	ns
Set-up time	tAS	140	-	-	ns
Data set-up time	tDSW	200	-	-	ns
Data delay time	tDDR	-	-	320	ns
Address hold time	tAH	10	-	-	ns
Data hold time (Write)	tDHW	10	-	-	ns
Data hold time (Read)	tDHR	20	-	-	ns



**INSTRUCTION SET KS0108/PT6608**

Instructions	Code									Function		
	R/W	D/I	D7	D6	D5	D4	D3	D2	D1		D0	
Display ON/OFF	0	0	0	0	1	1	1	1	1	1/0	Controls the ON/OFF of display. RAM data and internal status are not affected. 1:ON, 0:OFF	
Display start line	0	0	1	1	display start line (0 - 63)						Specifies a RAM line displayed at the top of screen	
Set page(X address)	0	0	1	0	1	1	1	Page (0 - 7)			Sets the page (x address) of RAM at the page of (x address) register.	
Set address	0	0	0	1	Y address (0 - 63)						Sets the Y address at the Y address counter	
Status Read	1	0	B U S Y	0	ON	R	0	0	0	0	Read the status.	
					/	E				RESET	1:reset 1:display OFF	0:normal 2:display ON
					OF	S				BUSY	1:on the internal operation	0:Ready
Write display data	0	1	Write data									Writes data D0 to D7 on the data bus into display RAM.
Read display data	1	1	Read data									Reads data D0 to D7 from the display RAM to the data bus. After access, Y address is increased by 1.

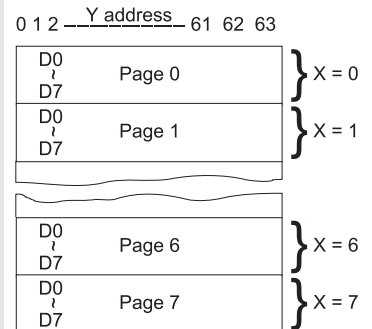

Address Configuration of Display Data RAM

A complete user manual for these on-board controller you'll find at our web site at "user manual" or direct accessed via: <http://www.lcd-module.de/eng/pdf/zubehoer/ks0108b.pdf> and [./pt6608.pdf](http://www.lcd-module.de/eng/pdf/zubehoer/pt6608.pdf)

# EA DIP128-6

Seite 4

## DIMENSIONS



## TOUCH PANEL

Surface of touch panel is anti-glare and scratch-proof.

Technology: resistive Matrix Touch with 5x3 fixed fields. Readout will be done like for membrane key-switches: scan for columns and rows.

Electrical Characteristics				
Specification	min	typ	max	Unit
On-Resistance	300		10,000	Ω
Voltage	0.5		5	V
Current	10u		10m	A
Contact Force	150		200	g
Contact Bounce		10		ms
Temperature range	-30		+75	°C
Lifetime	1,000,000			cycles

Touch Panel	
Pin	Function
1	Column 1
2	Row 1
3	Row 2
4	Row 3
5	N.C.
6	N.C.
7	Column 2
8	Column 3
9	Column 4
10	Column 5

## EA WF100-10S

ZIF connector for the touch panel as an accessory.

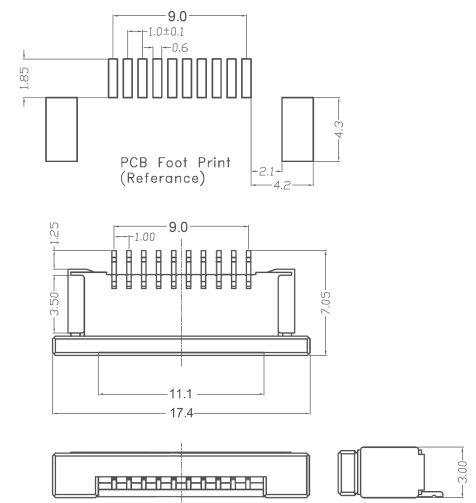

**ELECTRONIC ASSEMBLY**  
making things easy

# Mouser Electronics

Authorized Distributor

Click to View Pricing, Inventory, Delivery & Lifecycle Information:

## Display Visions:

[EA DIP128J-6N5LE](#) [EA B254-12](#) [EA DIP128J-6N5LW](#) [EA DIP128J6N5LWTP](#) [EA DIP128J6N5LATP](#) [EA DIP128-6N5LW](#) [EA DIP128-6N5LWTP](#) [EA WF100-10S](#) [EA DIP128-6N5LWT](#)