

Part Number: KP-2012P3C

Features

- 2.0mmx1.25mm SMD LED, 1.1mm thickness.
- Mechanically and spectrally matched to the infrared emitting LED lamp.
- Package : 2000pcs / reel.
- Moisture sensitivity level : level 3.
- RoHS compliant.

Description

Made with NPN silicon phototransistor chips.

Package Dimensions

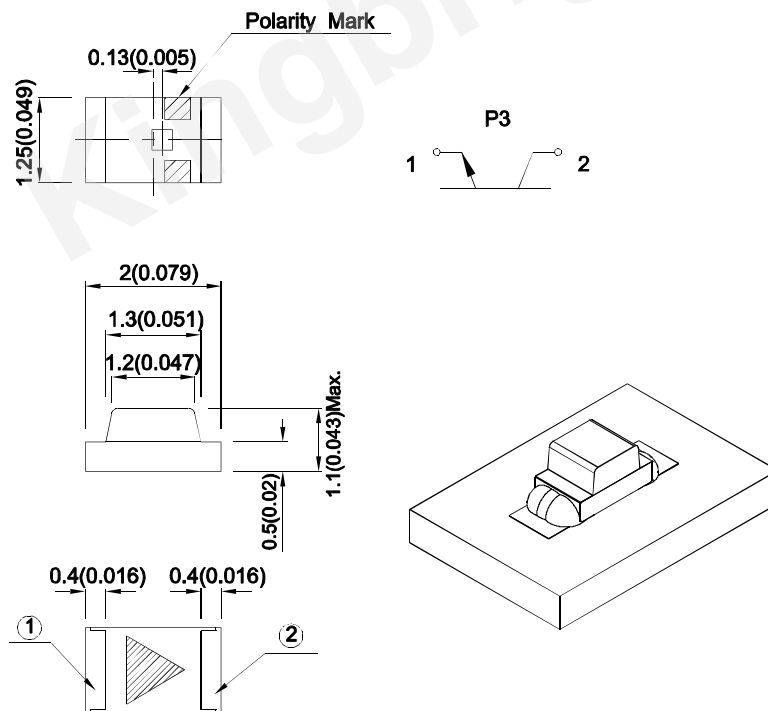

Notes:

1. All dimensions are in millimeters (inches).
2. Tolerance is $\pm 0.1(0.004)$ " unless otherwise noted.
3. The specifications, characteristics and technical data described in the datasheet are subject to change without prior notice.
4. The device has a single mounting surface. The device must be mounted according to the specifications.



Electrical / Optical Characteristics at TA=25°C

Symbol	Parameter	Min.	Typ.	Max.	Units	Test Conditions
V _{BR CEO}	Collector-to-Emitter Breakdown Voltage	30			V	I _C =100uA E _e =0mW/c m ²
V _{BR ECO}	Emitter-to-Collector Breakdown Voltage	5			V	I _E =100uA E _e =0mW/c m ²
V _{CE (SAT)}	Collector-to-Emitter Saturation Voltage			0.8	V	I _C =2mA E _e =20mW/c m ²
I _{CEO}	Collector Dark Current			100	nA	V _{CE} =10V E _e =0mW/c m ²
T _R	Rise Time (10% to 90%)		15		us	V _{CE} = 5V I _C =1mA R _L =1000Ω
T _F	Fall Time (90% to 10%)		15		us	
I _(ON)	On State Collector Current	0.2	0.4		mA	V _{CE} = 5V E _e =1mW/c m ² λ=940nm

Absolute Maximum Ratings at TA=25°C

Parameter	Max.Ratings
Collector-to-Emitter Voltage	30V
Emitter-to-Collector Voltage	5V
Power Dissipation at (or below) 25°C Free Air Temperature	100mW
Operating Temperature	-40°C To +85°C
Storage Temperature	-40°C To +85°C

Note:

- Relative humidity levels maintained between 40% and 60% in production area are recommended to avoid the build-up of static electricity – Ref JEDEC/JESD625-A and JEDEC/J-STD-033.

Typical Electro-Optical Characteristics Curves

Fig.1 Collector Power Dissipation vs. Ambient Temperature

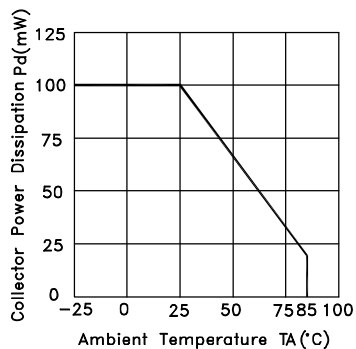
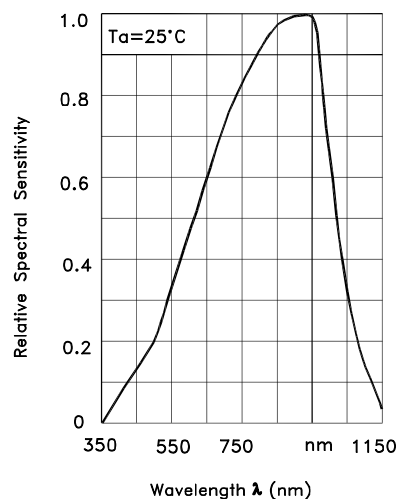
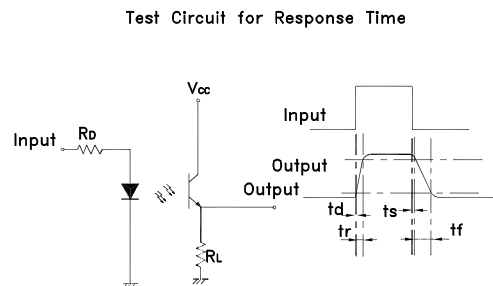
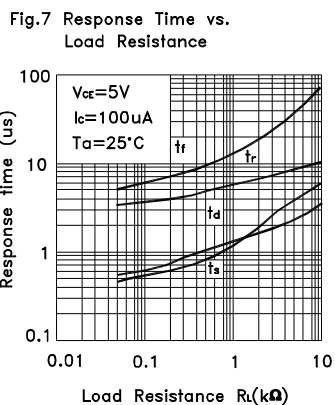
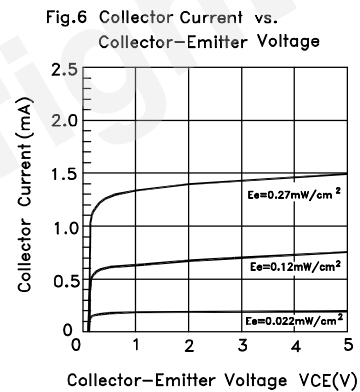
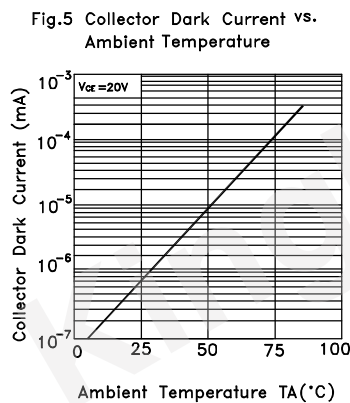
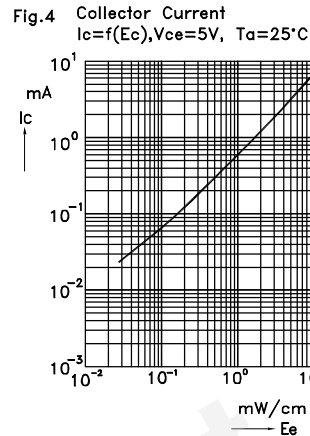
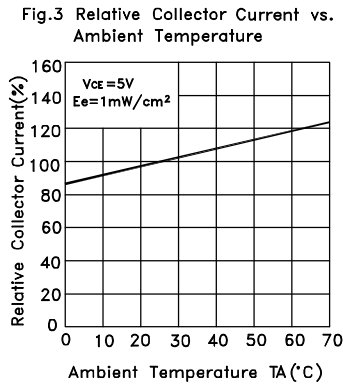

Fig.2 Spectral Sensitivity





KP-2012P3C

Reflow soldering is recommended and the soldering profile is shown below.
Other soldering methods are not recommended as they might cause damage to the product.

Reflow Soldering Profile For Lead-free SMT Process.

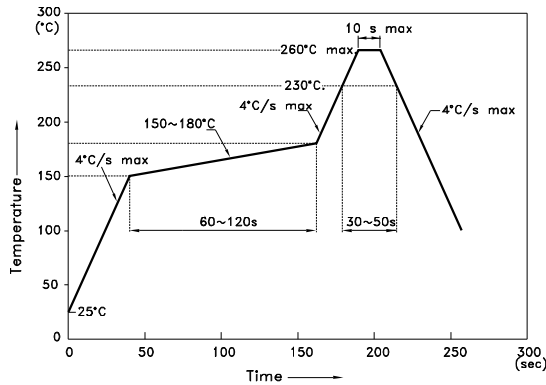

NOTES:

1. We recommend the reflow temperature 245°C(+/-5°C). The maximum soldering temperature should be limited to 260°C.
2. Don't cause stress to the epoxy resin while it is exposed to high temperature.
3. Number of reflow process shall be 2 times or less.

Recommended Soldering Pattern (Units : mm; Tolerance: ± 0.1)

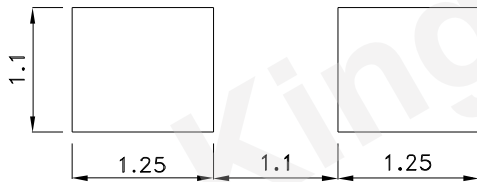

Reel Dimension

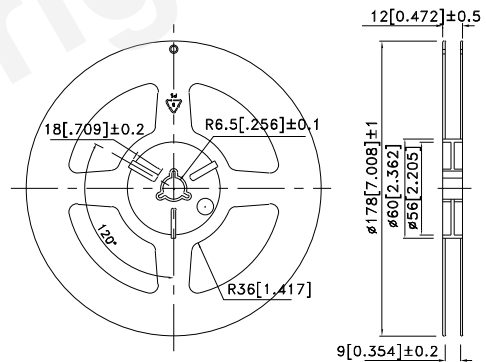

Tape Specifications (Units : mm)

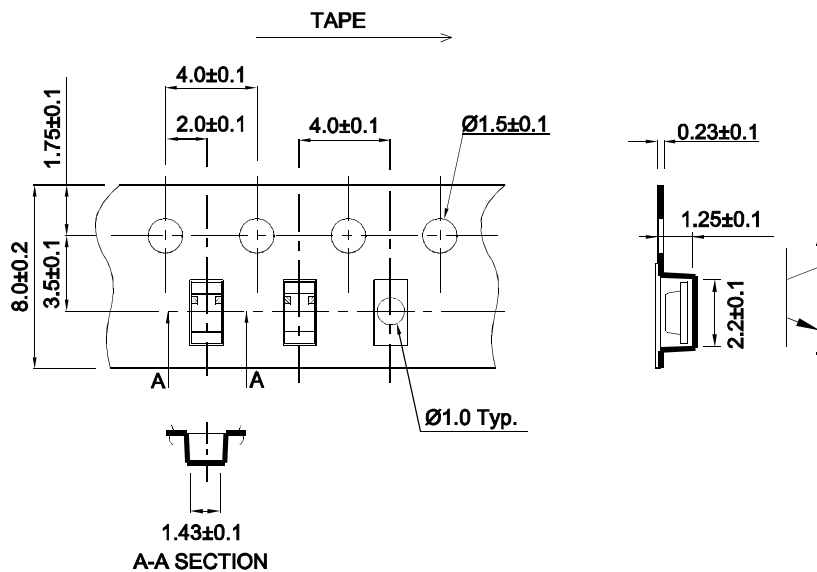

PACKING & LABEL SPECIFICATIONS

KP-2012P3C

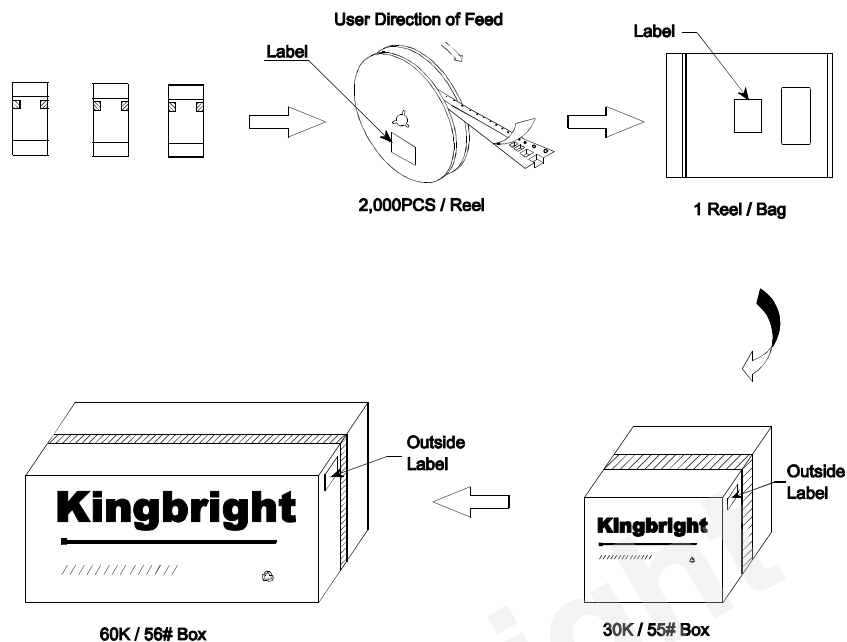

Kingbright					
P/NO: KP-2012xxx					
QTY: 2,000 PCS	Q.C.	<table border="1"> <tr> <td style="text-align: center;">Q C</td> </tr> <tr> <td style="text-align: center;">XX XX XXXX</td> </tr> <tr> <td style="text-align: center;">PASSED</td> </tr> </table>	Q C	XX XX XXXX	PASSED
Q C					
XX XX XXXX					
PASSED					
S/N: XXXX					
CODE: XXX					
LOT NO:					
RoHS Compliant					

Terms and conditions for the usage of this document

1. The information included in this document reflects representative usage scenarios and is intended for technical reference only.
2. The part number, type, and specifications mentioned in this document are subject to future change and improvement without notice. Before production usage customer should refer to the latest datasheet for the updated specifications.
3. When using the products referenced in this document, please make sure the product is being operated within the environmental and electrical limits specified in the datasheet. If customer usage exceeds the specified limits, Kingbright will not be responsible for any subsequent issues.
4. The information in this document applies to typical usage in consumer electronics applications. If customer's application has special reliability requirements or have life-threatening liabilities, such as automotive or medical usage, please consult with Kingbright representative for further assistance.
5. The contents and information of this document may not be reproduced or re-transmitted without permission by Kingbright.
6. All design applications should refer to Kingbright application notes available at http://www.kingbright.com/application_notes