

APPROVAL SHEET

**WW25P, WW20P, WW12P, WW10P,
WW08P, WW06P, WW04P**

±1%, ±5% 0.100Ω~0.976Ω

Thick Film High Power Low Ohm Chip Resistors

Size 2512 2W, 2010 1W, 1206 1/2W, 1210 1/2W,
0805 1/3W ; 0603 1/4W, 0402 1/8W

RoHS 2 Compliant with exemption 7C-I
Halogen free

*Contents in this sheet are subject to change without prior notice.

FEATURE

1. High power rating and compact size.
2. High reliability and stability.
3. Reduced size of final equipment.
4. RoHS 2 Compliant with exemption 7C-I and Halogen free.

APPLICATION

- Power supply
- PDA
- Digital meter
- Computer
- Automotives
- Battery charger
- DC-DC power converter

DESCRIPTION

The resistors are constructed in a high grade ceramic body (aluminum oxide). Internal metal electrodes are added at each end and connected by a resistive paste that is applied to the top surface of the substrate. The composition of the paste is adjusted to give the approximate resistance required and the value is trimmed to nominated value within tolerance which controlled by laser trimming of this resistive layer.

The resistive layer is covered with a protective coat. Finally, the two external end terminations are added. For ease of soldering the outer layer of these end terminations is Tin (lead free) alloy.

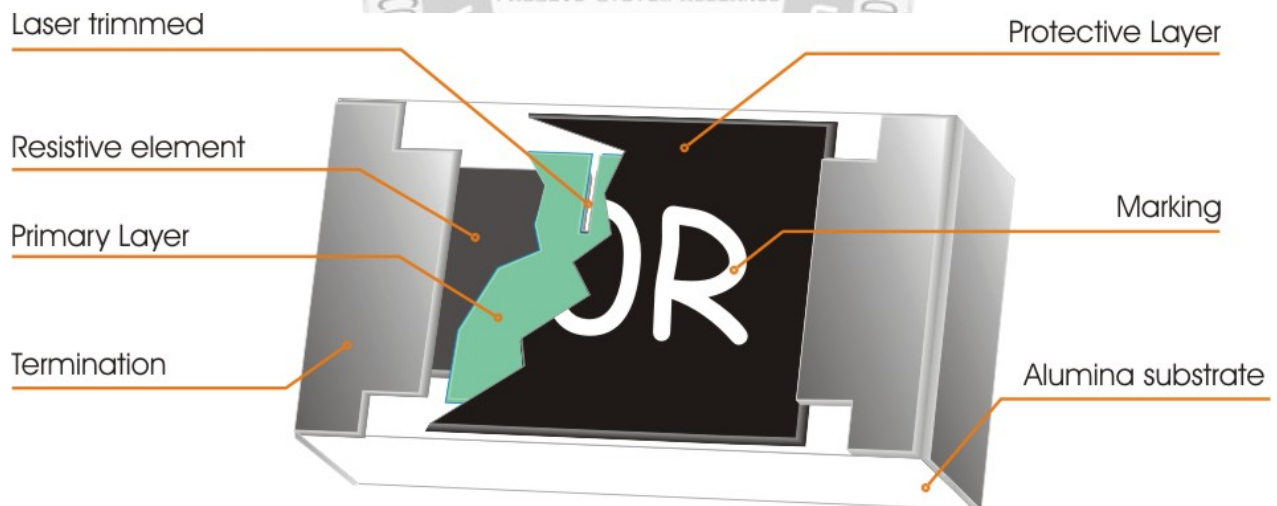

Fig 1. Construction of Chip-R

QUICK REFERENCE DATA

Item	General Specification						
Series No.	WW25P	WW20P	WW12P	WW10P	WW08P	WW06P	WW04P
Size code	2512 (6432)	2010 (5025)	1206 (3216)	1210 (3225)	0805 (2012)	0603 (1608)	0402 (1005)
Resistance Tolerance	±1% (E24+E96), ±5%						
Resistance Range	0.100Ω ~ 0.976Ω						
TCR (ppm/°C) 0.100Ω ~ 0.976Ω	±100ppm			±200ppm	±150ppm	±200ppm	±300ppm
Max. dissipation at T _{amb} =70°C	2 W	1W	1/2W	1/2W	1/3 W	1/4 W	1/8 W
Operation temperature	-55 ~ +155°C						

Note :

- 2W loading with total solder-pad and trace size of 300 mm²
- Resistance value will be changed by soldering condition and design of soldering pad, please design products in consideration of this change of resistance value
- Max. Operation Voltage : So called RCWV (Rated Continuous Working Voltage) is determined by

$$RCWV = \sqrt{\text{Rated Power} \times \text{Resistance Value}} \text{ or Max. RCWV listed above, whichever is lower.}$$

MECHANICAL DATA (Unit: mm)

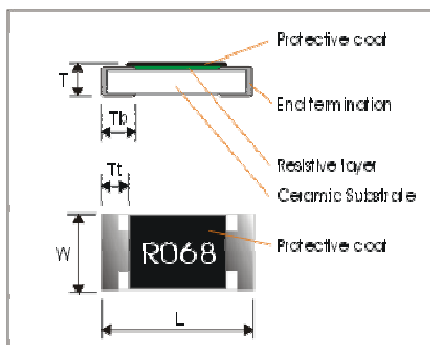

Symbol	WW25P	WW20P	WW10P	WW12P	WW08P	WW06P	WW04P
L	6.30 ± 0.20	5.00 ± 0.20	3.10 ± 0.10	3.10 ± 0.15	2.00 ± 0.10	1.60 ± 0.10	1.00 ± 0.05
W	3.10 ± 0.20	2.50 ± 0.20	2.50 ± 0.10	1.60 ± 0.15	1.25 ± 0.10	0.80 ± 0.10	0.50 ± 0.05
T	0.60 ± 0.15	0.60 ± 0.10	0.55 ± 0.10	0.55 ± 0.10	0.50 ± 0.15	0.45 ± 0.15	0.35 ± 0.05
Tt	0.60 ± 0.25	0.60 ± 0.25	0.50 ± 0.25	0.50 ± 0.25	0.40 ± 0.20	0.30 ± 0.10	0.20 ± 0.10
Tb	1.80 ± 0.25	0.60 ± 0.25	0.50 ± 0.25	0.50 ± 0.25	0.40 ± 0.20	0.30 ± 0.15	0.25 ± 0.10

Recommended Solder Pad Dimensions

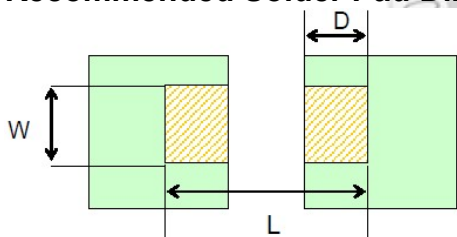

Type	W	D	L
WW25P	3.7mm	2.45mm	7.6mm

MARKING

For 0603 above size, each resistor is marked with a four-digit for 1% tolerance and three-digit for 5% tolerance on the protective coating to designate the nominal resistance value.

For 0402, no marking!

For Jumper, 2512/2010 defines 0000, 1206/0805/0603 defines 000.

Example:

102 = 1kΩ



16R0 = 16Ω



FUNCTIONAL DESCRIPTION

Product characterization

Standard values of nominal resistance are taken from the E96 & E24 series for resistors with a tolerance of $\pm 5\%$ & $\pm 1\%$. The values of the E24/E96 series are in accordance with "IEC publication 60063".

Derating curve

The power that the resistor can dissipate depends on the operating temperature; see Fig.2

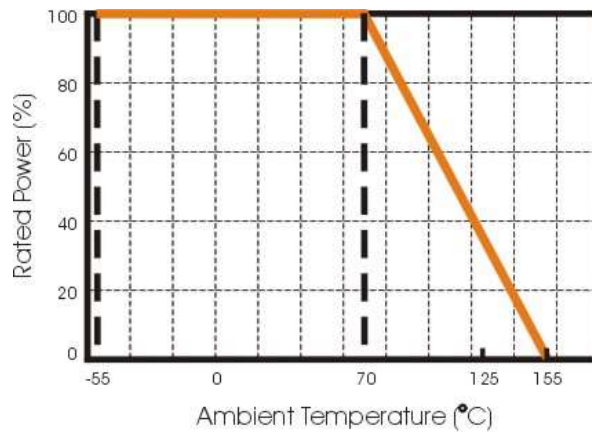

Figure 2 Maximum dissipation in percentage of rated power as a function of the ambient temperature

MOUNTING

Due to their rectangular shapes and small tolerances, Surface Mountable Resistors are suitable for handling by automatic placement systems.

Chip placement can be on ceramic substrates and printed-circuit boards (PCBs).

Electrical connection to the circuit is by individual soldering condition.

The end terminations guarantee a reliable contact.

SOLDERING CONDITION

The robust construction of chip resistors allows them to be completely immersed in a solder bath of 260°C for 10 seconds. Therefore, it is possible to mount Surface Mount Resistors on one side of a PCB and other discrete components on the reverse (mixed PCBs).

Surface Mount Resistors are tested for solderability at 235°C during 2 seconds. The test condition for no leaching is 260°C for 30 seconds. Typical examples of soldering processes that provide reliable joints without any damage are given in Fig 3.

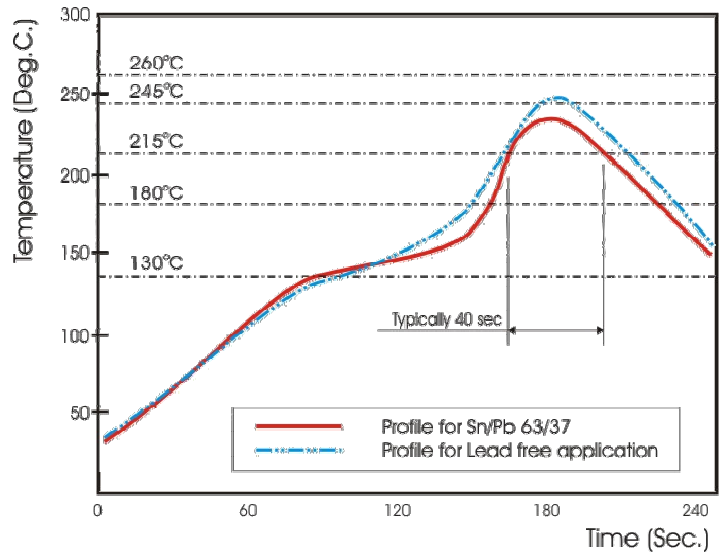

Fig 3. Infrared soldering profile for Chip Resistors

CATALOGUE NUMBERS

The resistors have a catalogue number starting with.

WW25	P	R100	J	T	L
Size code	Type code	Resistance code	Tolerance	Packaging code	Termination code
WW25 : 2512 WW20 : 2010 WW10 : 1210 WW12 : 1206 WW08 : 0805 WW06 : 0603 WW04 : 0402	P:Power	E96 +E24: "R" is first digit followed by 3 significant digits. e.g.: 0.1ohm = R100 0.56ohm = R560	J : ±5% F : ±1%	T : 7" Reel taping G : 13" Reel taping	L = Sn base (lead free)

Tape packaging WW12, WW10, WW08, WW06 : 8mm width paper taping 5,000pcs per reel.
WW04: 8mm width paper taping 10,000pcs per reel.
WW25, WW20: 12mm width plastic taping 4,000pcs per reel.

TEST AND REQUIREMENTS

Basic specification : JIS C 5201-1 : 1998

TEST	PROCEDURE	REQUIREMENT
Clause 4.8 Temperature Coefficient of Resistance (TCR)	Natural resistance change per change in degree centigrade. $\frac{R_2 - R_1}{R_1(t_2 - t_1)} \times 10^6 \text{ (ppm/}^\circ\text{C)}$ R ₁ : Resistance at reference temperature R ₂ : Resistance at test temperature t ₁ : 20°C+5°C-1°C	Refer to quick reference data for T.C.R specification
Clause 4.13 Short time overload	Permanent resistance change after 5 second application of a power 5.0 times of rated power or the maximum overload voltage specified in the above list, whichever is less.	ΔR/R max. J: ≤ ±(2%+0.5mΩ) F: ≤ ±(1%+0.5mΩ)
Clause 4.18 Resistance to soldering heat(R.S.H)	Un-mounted chips completely immersed for 10±1second in a SAC solder bath at 260°C±5°C	No visible damage ΔR/R max. J: ≤ ±(1%+0.5mΩ) F: ≤ ±(0.5%+0.5mΩ)
Clause 4.17 Solderability	Un-mounted chips completely immersed for 2±0.5second in a SAC solder bath at 235°C±5°C	Good tinning (>95% covered) No visible damage
Clause 4.19 Temperature cycling	30 minutes at -55°C±3°C, 2~3 minutes at 20°C+5°C-1°C, 30 minutes at +155°C±3°C, 2~3 minutes at 20°C+5°C-1°C, total 5 continuous cycles	No visible damage ΔR/R max. J: ≤ ±(1%+1mΩ) F: ≤ ±(0.5%+1mΩ)
Clause 4.25 Load life (endurance)	1000 +48/-0 hours, loaded with RCWV or Vmax in chamber controller 70±2°C, 1.5 hours on and 0.5 hours off	No visible damage ΔR/R max. J: ≤ ±(3%+0.5mΩ) F: ≤ ±(1%+0.5mΩ)
Clause 4.24 Load life in Humidity	1000 +48/-0 hours, loaded with RCWV or Vmax in humidity chamber controller at 40°C±2°C and 90~95% relative humidity, 1.5hours on and 0.5 hours off	No visible damage ΔR/R max. J: ≤ ±(3%+0.5mΩ) F: ≤ ±(1%+0.5mΩ)
Clause 4.33 Bending strength	Resistors mounted on a 90mm glass epoxy resin PCB(FR4); bending : 2 mm(2512;2010) 3mm(1206), once for 10 seconds	No visible damage ΔR/R max. J: ≤ ±(1%+1mΩ) F: ≤ ±(0.5%+1mΩ)
Clause 4.32 Adhesion	Pressurizing force: 5N, Test time: 10±1sec	No remarkable damage or removal of the terminations
Insulation Resistance	Apply the maximum overload voltage (DC) for 1minutes	R ≥ 10GΩ
Clause 4.6 Dielectric Withstand Voltage	Apply the maximum overload voltage (AC) for 1 minutes	No breakdown or flashover
Clause 4.7		

PACKAGING

Paper Tape(WW12P, WW10P, WW08P, WW06P, WW04P) & Plastic Tape(WW25P;WW20P)

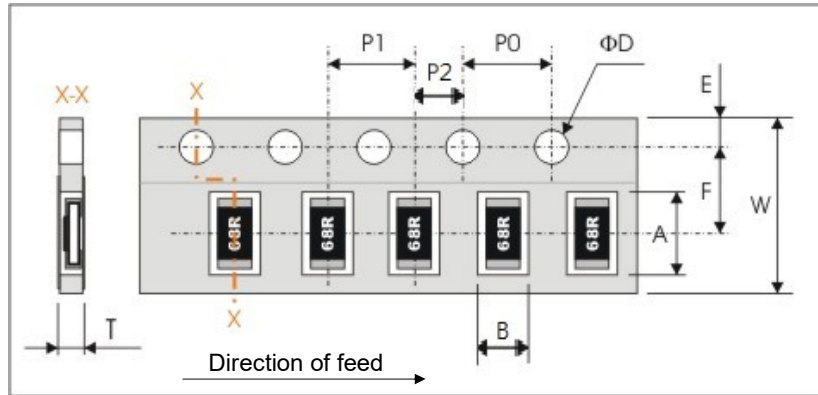

Series No.	A	B	W	F	E
WW25P	6.90±0.20	3.60±0.20	12.00±0.30	5.50±0.10	1.75±0.10
WW20P	5.50±0.20	2.80±0.20			
WW10P	3.60±0.20	3.00±0.20	8.00±0.30	3.50±0.20	
WW12P	3.60±0.20	2.00±0.20	8.00±0.30	3.50±0.20	
WW08P	2.40±0.20	1.65±0.20	8.00±0.30	3.50±0.20	
WW06P	1.90±0.20	1.10±0.20	8.00±0.30	3.50±0.20	
WW04P	1.20±0.10	0.70±0.10	8.00±0.30	3.50±0.20	

Series No.	P1	P0	P2	ΦD	T
WW25P	4.00±0.10	4.00±0.10	2.00±0.10	Φ1.50 ^{+0.1} _{-0.0}	Max.1.2
WW20P					
WW10P	4.00±0.10	4.00±0.10	2.00±0.10	Φ1.50 ^{+0.1} _{-0.0}	Max.1.0
WW12P					
WW08P					
WW06P	4.00±0.10	4.00±0.10	2.00±0.10	Φ1.50 ^{+0.1} _{-0.0}	0.65±0.05
WW04P	2.00±0.05	4.00±0.10	2.00±0.10		0.40±0.05

Reel dimensions

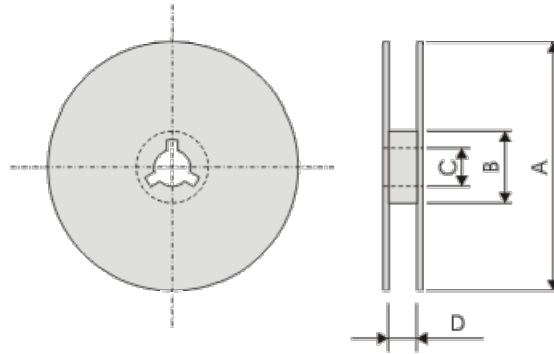

(unit : mm)

Reel / Tape	A	B	C	D
7" reel for 8mm tape	Φ178.0±2.0	Φ60.0±1.0	13.0±0.2	9.00±0.50
7" reel for 12mm tape				12.4±1.00
13" reel for 8mm tape	Φ330.0±2.00	Φ100.0±1.00	13.0±0.2	9.00±0.50

