

OSRAM V205Q121A-940

Datasheet

Published by **ams-OSRAM AG**

Tobelbader Strasse 30, 8141 Premstaetten, Austria

Phone +43 3136 500-0

ams-osram.com

© All rights reserved



BIDOS® P2433 Q

V205Q121A-940

940 nm Multi-Mode VCSEL Power Array
Designed for Sensor Field of Interest : 60° x 45°

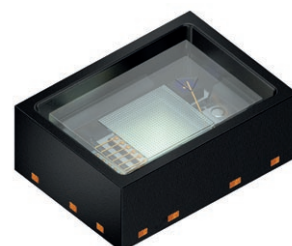

Applications

- 3D Sensing
- Access Control & Security
- Eye, face and hand tracking

Features

- Package: QFN Package
- ESD: 2 kV acc. to ANSI/ESDA/JEDEC JS-001 (HBM, Class 2)
- Very small SMT package
- VCSEL power array
- High optical power
- IR Laser with photodiode

Ordering Information

$I_F = 4 \text{ A}$; $t_p = 300 \text{ }\mu\text{s}$; $D = 0.05$; $T_A = 25 \text{ }^\circ\text{C}$

Type	Optical output power typ. P_{opt}	Ordering Code
V205Q121A-940	6.5 W	Q65113A2192

Depending on the mode of operation, these devices emit highly concentrated visible and non-visible light which can be hazardous to the human eye. Products which incorporate these devices must follow the safety precautions given in the "Notes" section.

Maximum Ratings

 $T_A = 25\text{ °C}$

Parameter	Symbol		Values
Operating temperature (refers to T_A ; $T_A = 85\text{ °C}$ with reduced efficiency)	T_{op}	min.	-20 °C
		max.	85 °C
Storage temperature	T_{stg}	min.	-40 °C
		max.	100 °C
Soldering temperature $t_{max} = 10\text{ s}$	T_S	max.	260 °C
ESD withstand voltage acc. to ANSI/ESDA/JEDEC JS-001 (HBM, Class 2)	V_{ESD}	max.	2 kV
IR Laser			
Junction temperature	T_j	max.	125 °C
Forward current pulsed $t_p \leq 600\text{ }\mu\text{s}$; $D = 0.01$	$I_{F\text{ pulse}}$	max.	4 A
Reverse voltage ⁵⁾	V_R	max.	Not designed for reverse operation
Photodiode			
Reverse voltage ⁵⁾	V_R	max.	20 V

Stresses beyond those listed under Absolute Maximum Ratings may cause permanent damage to the device.

Characteristics

$t_p = 300 \mu\text{s}$; $D = 0.05$; $T_A = 25 \text{ }^\circ\text{C}$

Parameter	Symbol		Values
IR Laser			
Peak wavelength ⁶⁾	λ_{peak}	min. typ. max.	931 nm 940 nm 949 nm
Optical output power ⁷⁾ $I_F = 4 \text{ A}$	P_{opt}	min. typ.	5.0 W 6.5 W
Field of view (HFOV) Angle at $E_e, 50\%$ level, normalized to the centroid	Θ_{\parallel}	typ.	66 °
Field of view (VFOV) Angle at $E_e, 50\%$ level, normalized to the centroid	Θ_{\perp}	typ.	53 °
Dimensions of chip area	$L \times W$	typ.	0.9 x 1.0 mm x mm
Slope efficiency $I_F = 1 \text{ A} \dots 2 \text{ A}$	η	min. typ.	1.50 W/ A 1.75 W/ A
Power conversion efficiency $I_F = 4 \text{ A}$	η_{tot}	typ.	45 %
Threshold current	I_{th}	typ. max.	0.5 A 0.9 A
Forward voltage ⁸⁾ $I_F = 4 \text{ A}$	V_F	min. typ. max.	3.0 V 3.7 V 4.5 V
Rise time 10% and 90% of $I_{e \text{ max}}$	t_r	typ.	1 ns
Fall time 10% and 90% of $I_{e \text{ max}}$	t_f	typ.	1 ns
Temperature coefficient of wavelength	TC_{λ}	typ.	0.07 nm/ K
Thermal resistance junction solder point real $t_p = 0.01 \text{ s}$	$R_{\text{thJS real}}$	max.	11 K/ W

Characteristics

$T_A = 25\text{ °C}$

Parameter	Symbol		Values
Photodiode			
Wavelength of max sensitivity	$\lambda_{S\text{ max}}$	typ.	840 nm
Spectral range of sensitivity	$\lambda_{10\%}$	typ.	400 ... 1100 nm
Photocurrent $\lambda = 940\text{ nm}$, $E_e = 0.5\text{ mW/cm}^2$, $V_R = 3.3\text{ V}$	I_P	typ.	0.188 μA
Photocurrent with VCSEL @ $I_F = 4\text{ A}$, $V_R = 3.3\text{ V}$	I_P	typ.	850 μA
Dimensions of chip area	$L \times W$	typ.	0.38 x 0.38 mm x mm
Forward voltage $I_F = 10\text{ mA}$, $E = 0$	V_F	typ. max.	0.85 V 1.00 V
Capacitance $E_e = 0\text{ mW/cm}^2$, $f = 1\text{ MHz}$, $V_R = 0\text{ V}$	C_0	typ.	1.3 pF
Dark current $V_R = 3.3\text{ V}$	I_R	typ. max.	0.1 nA 30 nA
Open-circuit voltage $\lambda = 940\text{ nm}$, $E_e = 0.5\text{ mW/cm}^2$	V_O	typ.	260 mV
Short-circuit current $\lambda = 940\text{ nm}$, $E_e = 0.5\text{ mW/cm}^2$, $V_R = 0\text{ V}$	I_{SC}	typ.	188 nA
Rise time $\lambda = 940\text{ nm}$, $V_R = 0.7\text{ V}$, $R_L = 50\ \Omega$	t_r	typ.	205 ns
Fall time $\lambda = 940\text{ nm}$, $V_R = 0.7\text{ V}$, $R_L = 50\ \Omega$	t_f	typ.	215 ns
Temperature coefficient of sensitivity $\lambda = 940\text{ nm}$, $E_e = 0.5\text{ mW/cm}^2$, $V_R = 3.3\text{ V}$	TC_I	typ.	0.23 %/ K

Relative Spectral Emission ^{1), 2)}

- infrared (940 nm): $I_{e,rel} = f(\lambda)$; $I_F = 4000 \text{ mA}$; $t_p = 300 \mu\text{s}$

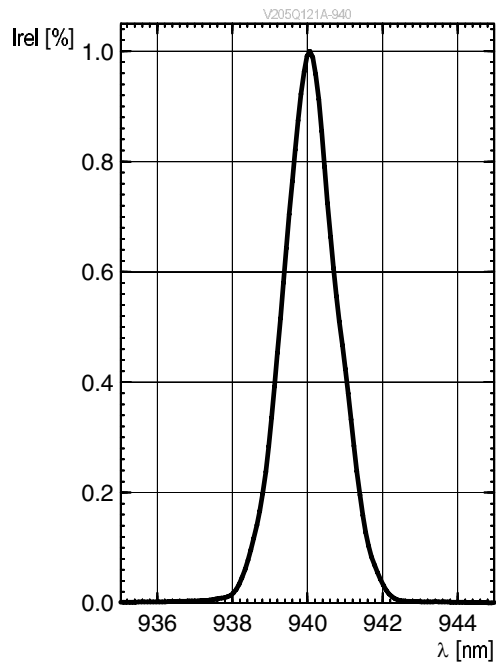

Radiation Characteristics ^{1), 2)}

- infrared (940 nm): $E_{e,rel} = f(\phi)$; $I_F = 4 \text{ A}$; $t_p = 300 \mu\text{s}$; $D = 0.05$

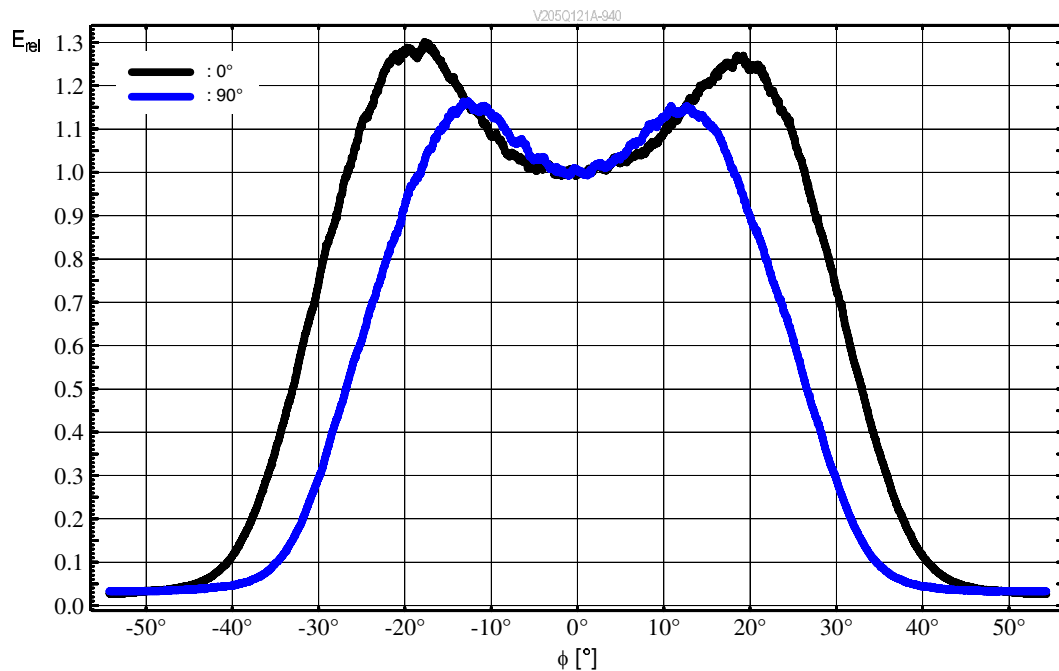

Far-Field Illumination Pattern ²⁾

- infrared (940 nm): $I_{rel} = f(\phi)$; $I_F = 4 \text{ A}$; $t_p = 300 \mu\text{s}$; $D = 0.05$

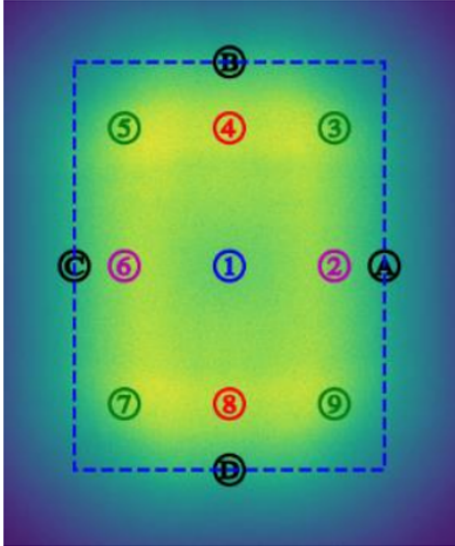

Sensor FOI 60°(H) x 45°(V) (dotted line)

	Min	Typ	Max
1	100%	100%	100%
2	90%	110%	130%
3	90%	110%	130%
4	100%	123%	145%
5	90%	110%	130%
6	90%	110%	130%
7	90%	110%	130%
8	100%	123%	145%
9	90%	110%	130%
A	65%	85%	105%
B	65%	85%	105%
C	65%	85%	105%
D	65%	85%	105%

Relative Spectral Sensitivity ^{1), 2)}

- photodiode: $S_{rel} = f(\lambda)$; $V_R = 3.3\text{ V}$

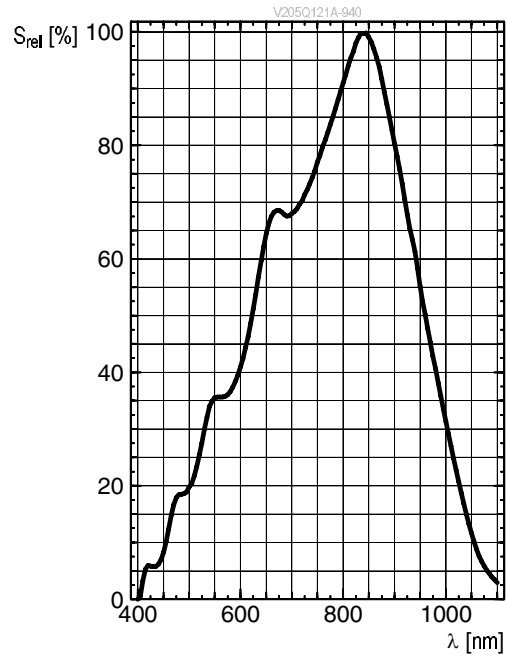

Optical Output Power ^{1), 2)}

- infrared (940 nm): $P_{opt} = f(I_F)$; $t_p = 300\ \mu\text{s}$; $D = 0.05$

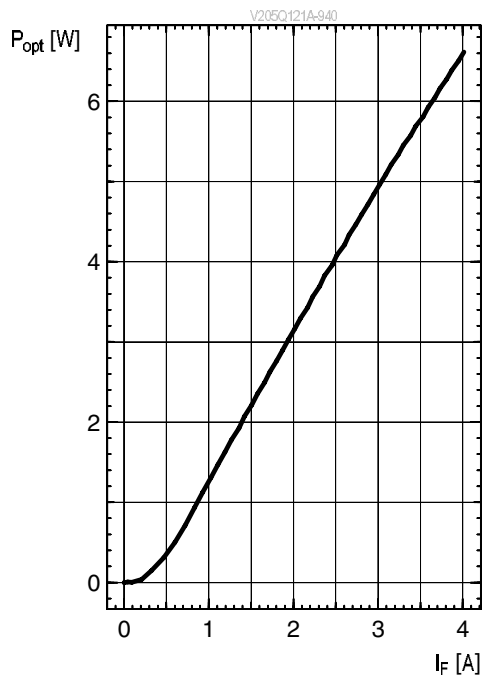

Forward Voltage ^{1), 2)}

- infrared (940 nm): $V_F = f(I_F)$; $t_p = 300\ \mu\text{s}$; $D = 0.05$

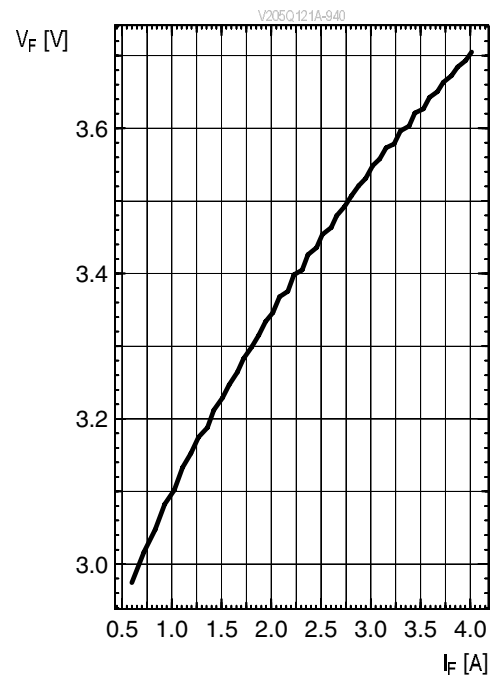

Photocurrent 1), 2)

■ photodiode: $I_p = f(P_{opt})$

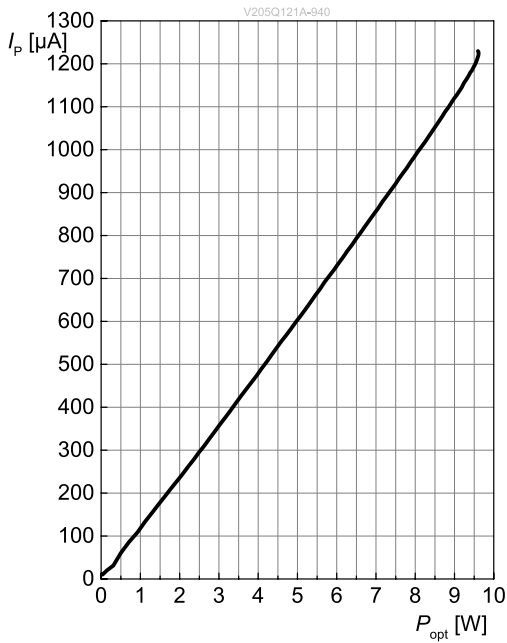

Dark Current 1), 2)

■ photodiode: $I_R = f(V_R)$

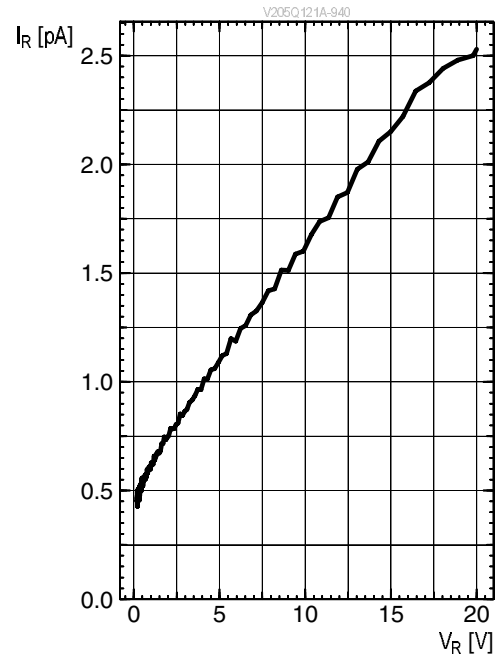

Capacitance 1), 2)

■ photodiode: $C = f(V_R); E = 0$

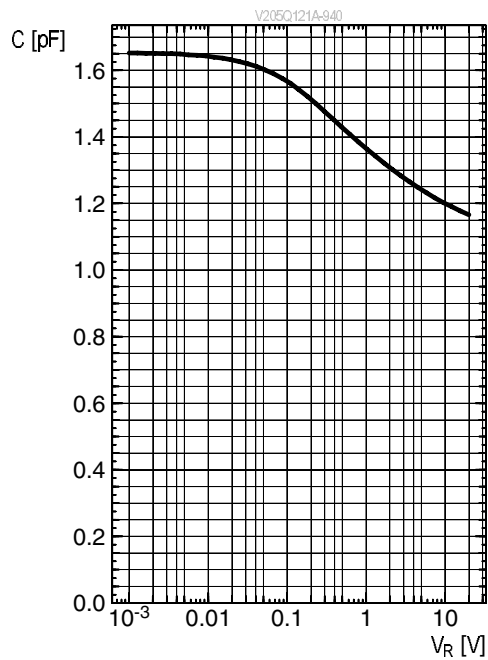

Dark Current ¹⁾

- photodiode: $I_R = f(T_A)$; $E = 0$; $V_R = 3.3\text{ V}$

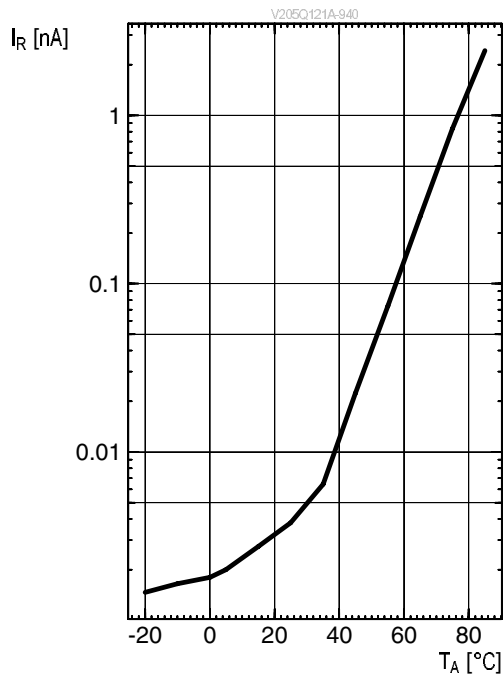

Permissible Pulse Handling Capability

- infrared (940 nm): $I_F = f(t_p)$; $D = \text{param.}$; $T_S = 85^\circ\text{C}$;
(not characterized for DC condition)

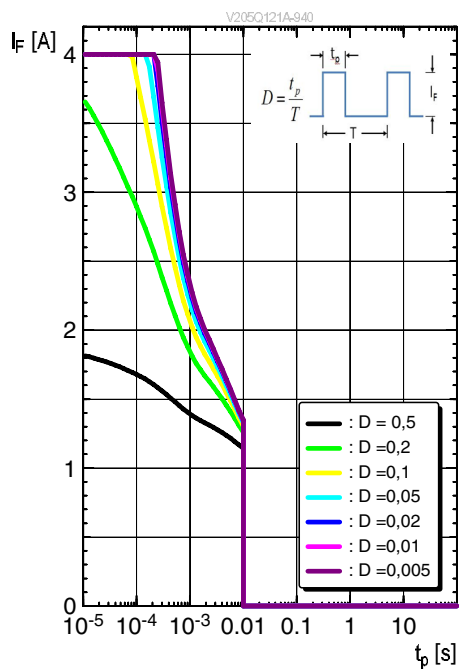

Dimensional Drawing ³⁾

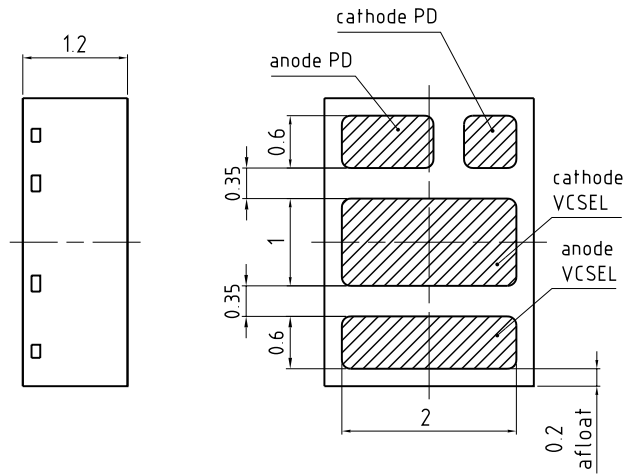
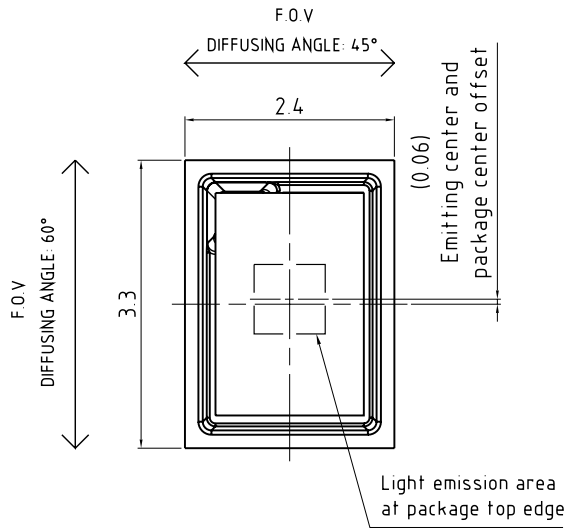

general tolerance ± 0.1

lead finish Au 

C67062-A0363-A1-06

Further Information:

Approximate Weight: 20.0 mg

Recommended Solder Pad ³⁾

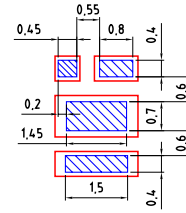
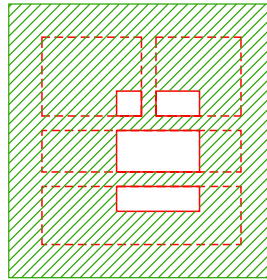
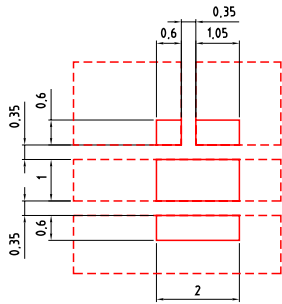

Component Location on Pad

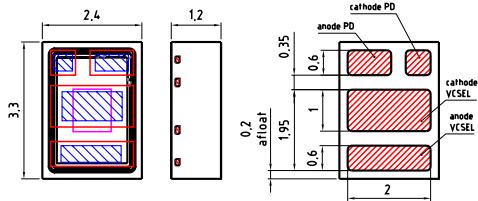

E062.3010.294-03

Reflow Soldering Profile

Product complies to MSL Level 3 acc. to JEDEC J-STD-020E

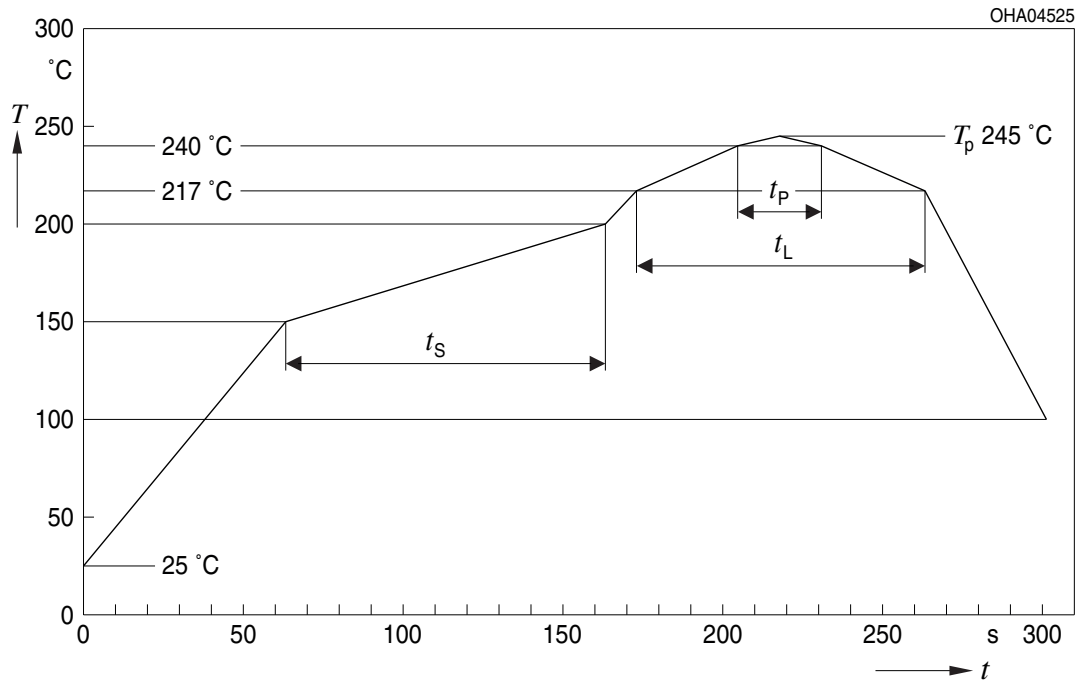

Profile Feature	Symbol	Pb-Free (SnAgCu) Assembly			Unit
		Minimum	Recommendation	Maximum	
Ramp-up rate to preheat ^{*)} 25 °C to 150 °C			2	3	K/s
Time t_s T_{Smin} to T_{Smax}	t_s	60	100	120	s
Ramp-up rate to peak ^{*)} T_{Smax} to T_p			2	3	K/s
Liquidus temperature	T_L		217		°C
Time above liquidus temperature	t_L		80	100	s
Peak temperature	T_p		245	260	°C
Time within 5 °C of the specified peak temperature $T_p - 5$ K	t_p	10	20	30	s
Ramp-down rate* T_p to 100 °C			3	6	K/s
Time 25 °C to T_p				480	s

All temperatures refer to the center of the package, measured on the top of the component

* slope calculation DT/Dt : Dt max. 5 s; fulfillment for the whole T-range

Taping ³⁾

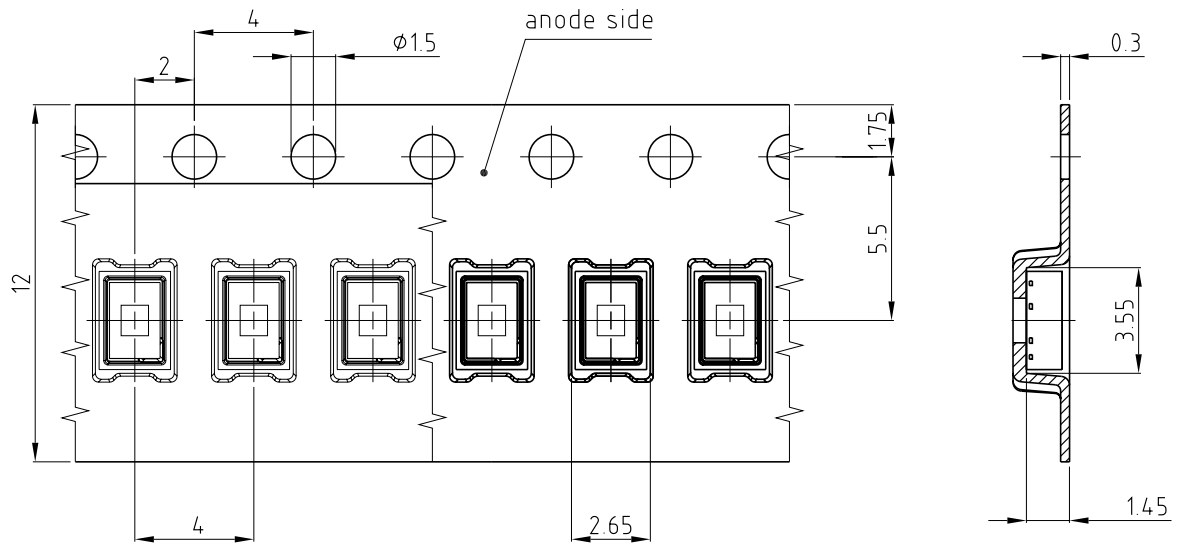

C67062-A0363-B6-04

Tape and Reel ⁴⁾

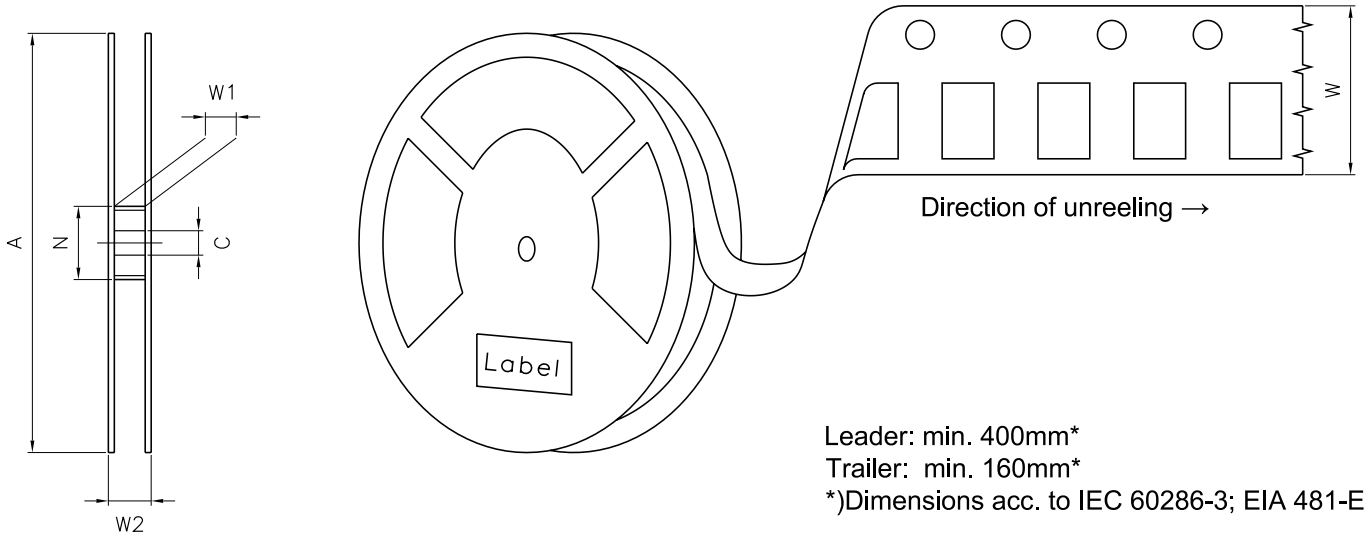

Reel Dimensions

A	W	N _{min}	W ₁	W _{2max}	Pieces per PU
180 mm	12 + 0.3 / - 0.1 mm	60 mm	12.4 + 2 mm	18.4 mm	2000

Barcode-Product-Label (BPL)

OSRAM LX XXXX BIN1: XX-XX-X-XXX-X

RoHS Compliant

(6P) BATCH NO: 1234567890

(1T) LOT NO: 1234567890 (9D) D/C: 1234

(X) PROD NO: 123456789 (Q) QTY: 9999 (G) GROUP: XX-XX-X-X

ML Temp ST
X XXX °C X

Pack: RXX
DEMY XXX
X_X123_1234.1234 X

OHA04563

Dry Packing Process and Materials

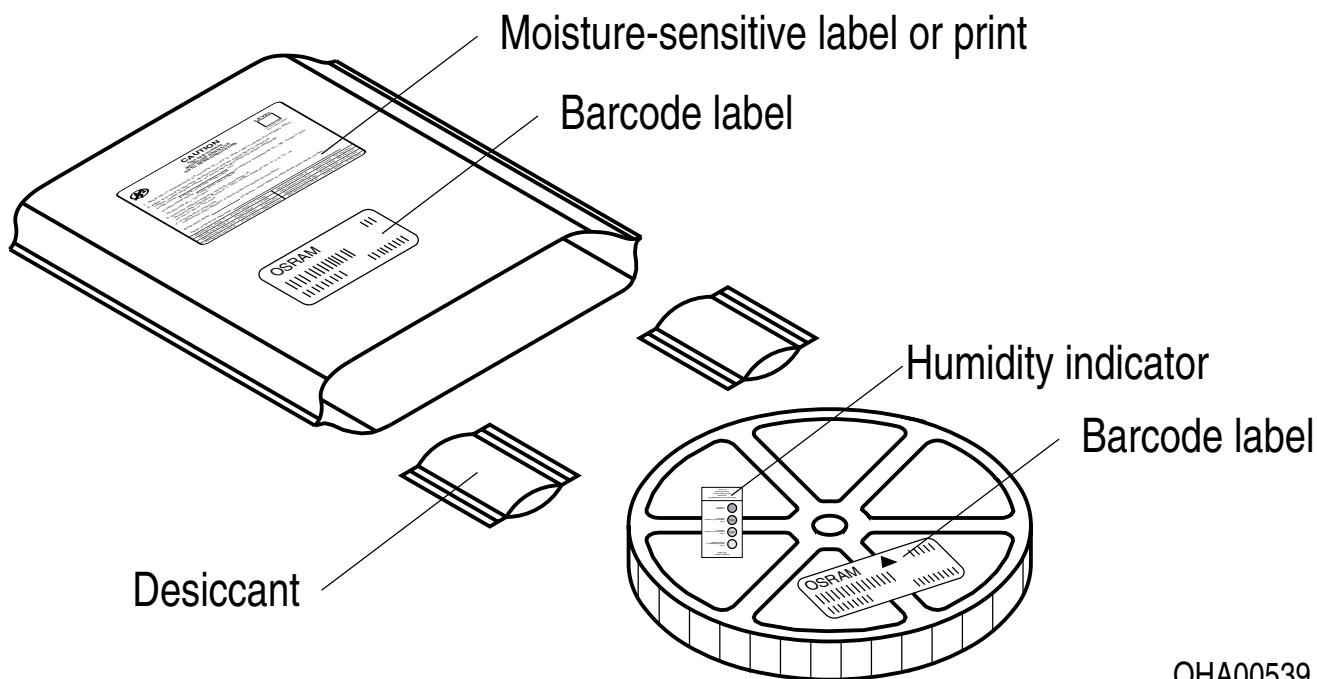

OHA00539

Notes

Depending on the mode of operation, these devices emit highly concentrated visible and non visible light which can be hazardous to the human eye. Products which incorporate these devices have to follow the safety precautions given in IEC 60825-1.

Subcomponents of this device contain, in addition to other substances, metal filled materials including silver. Metal filled materials can be affected by environments that contain traces of aggressive substances. Therefore, we recommend that customers minimize device exposure to aggressive substances during storage, production, and use. Devices that showed visible discoloration when tested using the described tests above did show no performance deviations within failure limits during the stated test duration. Respective failure limits are described in the IEC60810.

For further application related information please visit <https://ams-osram.com/support/application-notes>

Disclaimer

Attention please!

The information describes the type of component and shall not be considered as assured characteristics. Terms of delivery and rights to change design reserved. Due to technical requirements components may contain dangerous substances.

For information on the types in question please contact our Sales Organization.

If printed or downloaded, please find the latest version on our website.

Packing

Please use the recycling operators known to you. We can also help you – get in touch with your nearest sales office. By agreement we will take packing material back, if it is sorted. You must bear the costs of transport. For packing material that is returned to us unsorted or which we are not obliged to accept, we shall have to invoice you for any costs incurred.

Product and functional safety devices/applications or medical devices/applications

Our components are not developed, constructed or tested for the application as safety relevant component or for the application in medical devices.

Our products are not qualified at module and system level for such application.

In case buyer – or customer supplied by buyer – considers using our components in product safety devices/ applications or medical devices/applications, buyer and/or customer has to inform our local sales partner immediately and we and buyer and /or customer will analyze and coordinate the customer-specific request between us and buyer and/or customer.

Glossary

- 1) **Typical Values:** Due to the special conditions of the manufacturing processes of semiconductor devices, the typical data or calculated correlations of technical parameters can only reflect statistical figures. These do not necessarily correspond to the actual parameters of each single product, which could differ from the typical data and calculated correlations or the typical characteristic line. If requested, e.g. because of technical improvements, these typ. data will be changed without any further notice.
- 2) **Testing temperature:** $T_A = 25^\circ\text{C}$ (unless otherwise specified)
- 3) **Tolerance of Measure:** Unless otherwise noted in drawing, tolerances are specified with ± 0.1 and dimensions are specified in mm.
- 4) **Tape and Reel:** All dimensions and tolerances are specified acc. IEC 60286-3 and specified in mm.
- 5) **Reverse Operation:** This product is intended to be operated applying a forward current within the specified range. Applying any continuous reverse bias or forward bias below the voltage range of light emission shall be avoided because it may cause migration which can change the electro-optical characteristics or damage the LED.
- 6) **Wavelength:** The wavelengths are measured with a tolerance of ± 1 nm.
- 7) **Brightness:** The brightness values are measured with a tolerance of $\pm 11\%$.
- 8) **Forward Voltage:** The forward voltages are measured with a tolerance of ± 0.1 V.

Revision History

Version	Date	Change
1.0	2021-10-01	Initial Version
1.1	2023-05-04	Applications Maximum Ratings New Layout Characteristics
1.2	2024-06-26	Recommended Solder Pad Taping



EU RoHS and China RoHS compliant product

此产品符合欧盟 RoHS 指令的要求；
按照中国的相关法规和标准，
不含有毒有害物质或元素。

Published by ams-OSRAM AG

Tobelbader Strasse 30, 8141 Premstaetten, Austria

Phone +43 3136 500-0

ams-osram.com

© All rights reserved

am 

OSRAM

Mouser Electronics

Authorized Distributor

Click to View Pricing, Inventory, Delivery & Lifecycle Information:

[ams OSRAM:](#)

[V205Q121A-940](#)