



|   |          |                    |          |
|---|----------|--------------------|----------|
| SIGN  | DATE     | DESCRIPTION        | APPROVER |
| △   | 07/09'13 | update the drawing | Guoxue   |
| <i>THIS IS CAD DRAWING, DO NOT REVISE MANUALLY!!!</i> |          |                    |          |

**Materials**

- Item a Terminal housing : Thermoplastic (UL94V-0)
- Item b Terminal screw : Steel Zinc plating "--" slot type
- Item c Wire guard solder pin 1 : Brass ,Tin plated
- Item d Wire guard solder pin 2 : Brass ,Tin plated
- Item e Wire guard solder pin 3 : Brass ,Tin plated
- Item f Clamp : Brass, Ni Plated

**Electrical cULus**

- Voltage rating: 300VAC
- Current rating: 10A
- Wire range:
- Solid wire(AWG): 12-30
- Stranded wire(AWG): 12-30
- Torque(Lb-In): 5.0
- Screw: M3
- Wire strip length: 7-8mm
- Withstanding Voltage: 1.6KV
- Operating temperature: -40°C to +115°C
- Soldering temperature: 260°C±5°C/5 Sec
- Safety Approval:  us
- Critical dimension: 

**E6 03 0 1 x 1 xxxx G**

- COLOR
- 0 Black (RAL9005)
  - 2 Red (RAL3001/D)
  - 3 Orange(RAL2011/P)
  - 4 Yellow(RAL1018/A)
  - 5 Green(RAL6018/T)
  - 6 Blue (RAL5015/A)
  - 8 Grey(RAL7035/D)
  - 9 White(RAL1102)
  - C Green(RAL6018/U)

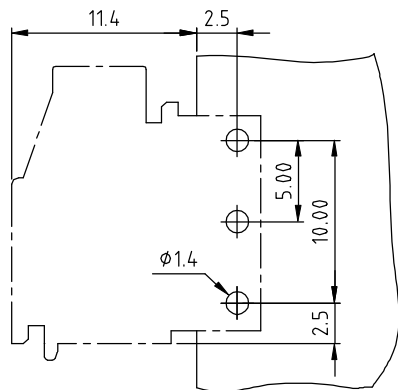
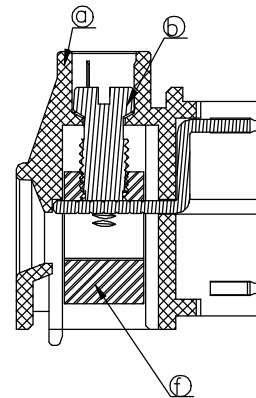
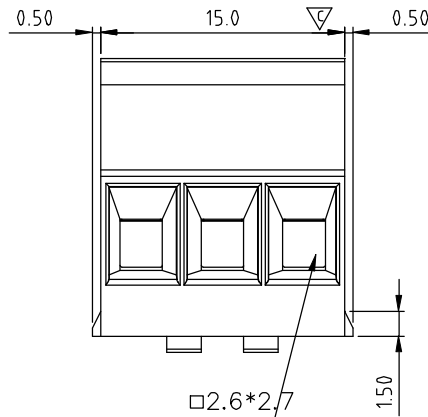
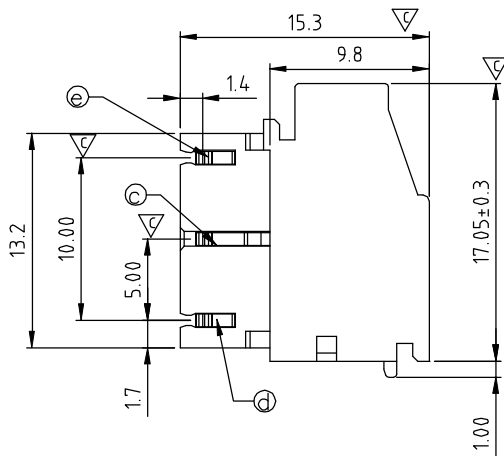
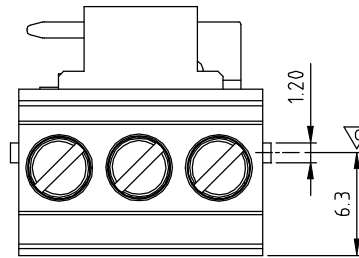

G RoHS compliant  
(lead<4%)  
In copper Alloy

0000: "@" Logo (Standard)  
000A: "ANYTEK" Mark  
Any special item by  
customer request.  
please contact sales  
department.

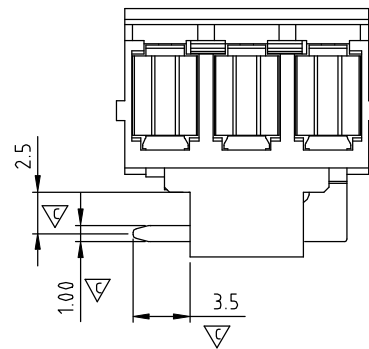

P.C.B Layout



|   |         |                                |                      |   |  |             |  |         |
|---|---------|--------------------------------|----------------------|---|--|-------------|--|---------|
| <b>ANYTEK</b>   |         |                                |                      | <b>CUSTOMER COPY</b>  |  |             |  |         |
| ALL RIGHTS RESERVED. REPRODUCTION OR ISSUE TO THIRD PARTIES IN ANY FORM WHATSOEVER IS NOT PERMITTED WITHOUT WRITTEN AUTHORITY FROM THE PROPRIETOR. PROPERTY OF ANYTEK TECHNOLOGY CO., LTD |         |                                |                      |   |  |             |  |         |
| TITLE   |         | E6 5.0 SERIES 3P (Left)--Brass |                      |   |  | DWG NO.     |  | 8E60016 |
| PART NO.  |         | E60301x1xxxxG                  |                      |   |  | CUST NO.    |  |         |
| APPROVED  | CHECKED | DESIGNED                       | DRAWN                | Tolerance   |  |             |  |         |
|   |         | Guoxue<br>2013.07.19           | Guoxue<br>2013.07.19 |   |  |             |  |         |
|   |         |                                |                      |  |  | UNIT: mm    |  |         |
|   |         |                                |                      |  |  | SCALE: NONE |  |         |
|   |         |                                |                      | SHEET: 01/01  |  | REV.: C     |  |         |
|   |         |                                |                      | X. ±0.5   |  | X.X ±0.3    |  |         |
|   |         |                                |                      | X.XX ±0.1   |  | X° ±1°      |  |         |

# Mouser Electronics

Authorized Distributor

Click to View Pricing, Inventory, Delivery & Lifecycle Information:

[Amphenol:](#)

[E60301510000G](#)