

TOSHIBA CMOS Linear Integrated Circuit Silicon Monolithic

# TCR15AG series

1.5 A CMOS Ultra Low Dropout, Ultra High ripple rejection ratio Regulator

## 1. Description

The TCR15AG series are CMOS single output voltage regulators with an on/off control input, featuring Ultra low dropout voltage, low inrush current and fast load transient response.

These voltage regulators are available in fixed output voltage type from 0.65 V to 3.6 V and adjustable output voltage type from 0.60 V to 3.6 V and capable of driving up to 1.5 A.

Other features include Overcurrent protection, Thermal shutdown, Inrush current reduction, Under voltage lockout and Auto-discharge.

The TCR15AG series are offered in the ultra-small package WCSP6F (0.8 mm x 1.2 mm (typ.), t: 0.33 mm (max))

As small ceramic input and output capacitors can be used with the TCR15AG series, these device are ideal for portable applications that require high-density board assembly such as cellular phones.

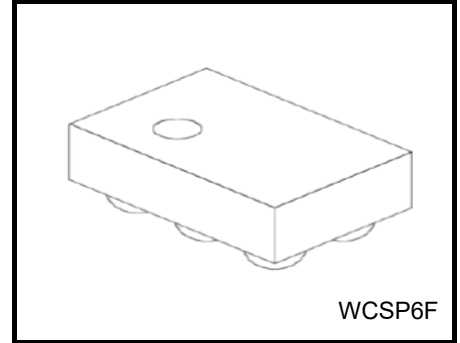

Weight: 0.61 mg (typ.)

## 2. Applications

Power IC developed for portable applications.

## 3. Features

- Low Drop-Out voltage
- Wide range Output Voltage (Fixed Output Voltage 0.65 V to 3.6 V, Adjustable Output Voltage 0.6 V to 3.6 V)
- Fast load transient response  $-100 / +115$  mV (typ.) @ 0.01 A  $\leftrightarrow$  1.5 A,  $C_{OUT} = 4.7 \mu\text{F}$
- High Ripple rejection ratio 95 dB (typ.) @ 1 kHz
- Overcurrent protection
- Thermal shutdown
- Auto-discharge
- Inrush current reduction
- Output voltage soft start
- Under voltage lockout
- Pull down connection between CONTROL and GND
- Ultra Small package WCSP6F (0.8 mm x 1.2 mm (typ.), t: 0.33 mm (max))
- Stable with over 4.7  $\mu\text{F}$  Input capacitor, 1.0  $\mu\text{F}$  Bias capacitor and 4.7  $\mu\text{F}$  output ceramic capacitor

Start of commercial production  
2017-11

### 4. Absolute Maximum Ratings (Ta = 25°C)

Characteristics	Symbol	Rating	Unit
Bias voltage	V <sub>BIAS</sub>	6.0	V
Input voltage	V <sub>IN</sub>	6.0	V
Control voltage	V <sub>CT</sub>	-0.3 ~ V <sub>BIAS</sub> + 0.3 ≤ 6.0	V
Adjustable voltage	V <sub>ADJ</sub>	-0.3 ~ 6.0	V
Sense voltage	V <sub>SENSE</sub>	-0.3 ~ 6.0	V
Output voltage	V <sub>OUT</sub>	-0.3 ~ V <sub>IN</sub> + 0.3 ≤ 6.0	V
Power dissipation	P <sub>D</sub>	1.35 (Note 1)	W
Junction temperature	T <sub>j</sub>	150	°C
Storage temperature range	T <sub>stg</sub>	-55 ~ 150	°C

Note: Using continuously under heavy loads (e.g. the application of high temperature/current/voltage and the significant change in temperature, etc.) may cause this product to decrease in the reliability significantly even if the operating conditions (i.e. operating temperature/current/voltage, etc.) are within the absolute maximum ratings and the operating ranges.

Please design the appropriate reliability upon reviewing the Toshiba Semiconductor Reliability Handbook (“Handling Precautions”/“Derating Concept and Methods”) and individual reliability data (i.e. reliability test report and estimated failure rate, etc).

Note1 : Rating at mounting on a board  
 Glass epoxy board dimension: 40mm x 40mm, 4 layer  
 Metal pattern ratio: approximately 70% each layer

### 5. Operating ranges

Characteristics	Symbol	Rating	Unit
Bias voltage	V <sub>BIAS</sub>	V <sub>OUT</sub> ≤ 1.1 V, I <sub>OUT</sub> = 1 mA	2.5 to 5.5
		V <sub>OUT</sub> > 1.1 V, I <sub>OUT</sub> = 1 mA	V <sub>OUT</sub> + 1.4 V to 5.5
Input voltage	V <sub>IN</sub>	V <sub>OUT</sub> + V <sub>DO</sub> to V <sub>BIAS</sub> (Note 2)	V
Control voltage	V <sub>CT</sub>	0 to V <sub>BIAS</sub>	V
Output voltage	V <sub>OUT</sub>	0.6 to 3.6 (Note 3)	V
Output current	I <sub>OUT</sub>	0 to 1.5 (Note 4)	A
Operation Temperature	T <sub>opr</sub>	-40 to 85	°C
Output Capacitance	C <sub>OUT</sub>	≥ 4.7μF	—
Input Capacitance	C <sub>IN</sub>	≥ 4.7μF	—
BIAS Capacitance	C <sub>BIAS</sub>	≥ 1.0μF	—

Note 2: I<sub>OUT</sub> = 1 mA.

Please refer to Dropout Voltage (Page 7) and use it within Absolute Maximum Ratings Junction temperature and Operation Temperature Ranges.

Note 3: For Output voltage adjustable type. Please refer to Application Note (Page 8).

Note 4: Do not operate at or near the maximum recommended current and temperature ratings listed for extended periods of time. Exposure to such conditions may adversely impact product reliability and results in failures not covered by warranty. Maximum recommended DC current specification defined as lifetime average junction temperature of +45°C where max rated DC current = lifetime average current to avoid electro migration.

### 6. Pin Assignment (top view)

Fixed Output Voltage

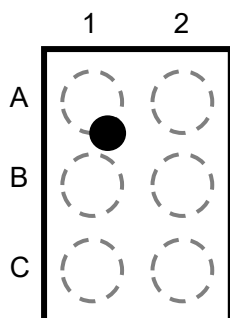

	1	2
A	V <sub>OUT</sub>	V <sub>IN</sub>
B	SENSE	CONTROL
C	GND	V <sub>BIAS</sub>

Adjustable Output Voltage

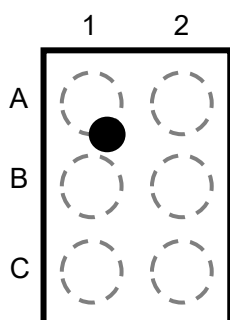

	1	2
A	V <sub>OUT</sub>	V <sub>IN</sub>
B	V <sub>ADJ</sub>	CONTROL
C	GND	V <sub>BIAS</sub>

### 7. List of Products Number, Output voltage and Marking

Product No.	V <sub>OUT</sub> (V) (typ.)	Marking	Product No.	V <sub>OUT</sub> (V) (typ.)	Marking
TCR15AG065*	0.65	0KA	TCR15AG21*	2.1	2K1
TCR15AG07*	0.7	0K7	TCR15AG22*	2.2	2K2
TCR15AG075*	0.75	0KB	TCR15AG23*	2.3	2K3
TCR15AG08*	0.8	0K8	TCR15AG24*	2.4	2K4
TCR15AG085*	0.85	0KC	TCR15AG25	2.5	2K5
TCR15AG09	0.9	0K9	TCR15AG26*	2.6	2K6
TCR15AG095*	0.95	0KF	TCR15AG27*	2.7	2K7
TCR15AG10	1.0	1K0	TCR15AG275	2.75	0KP
TCR15AG105	1.05	0KH	TCR15AG28	2.8	2K8
TCR15AG11	1.1	1K1	TCR15AG285*	2.85	0KR
TCR15AG115*	1.15	0KJ	TCR15AG29*	2.9	2K9
TCR15AG12	1.2	1K2	TCR15AG295*	2.95	0KT
TCR15AG125*	1.25	0KK	TCR15AG30	3.0	3K0
TCR15AG13*	1.3	1K3	TCR15AG305*	3.05	0KU
TCR15AG135*	1.35	0KL	TCR15AG31*	3.1	3K1
TCR15AG14*	1.4	1K4	TCR15AG32*	3.2	3K2
TCR15AG15*	1.5	1K5	TCR15AG325*	3.25	0KW
TCR15AG16*	1.6	1K6	TCR15AG33	3.3	3K3
TCR15AG17*	1.7	1K7	TCR15AG335*	3.35	0KX
TCR15AG175*	1.75	0KM	TCR15AG34*	3.4	3K4
TCR15AG18	1.8	1K8	TCR15AG35*	3.5	3K5
TCR15AG185	1.85	0KN	TCR15AG36*	3.6	3K6
TCR15AG19*	1.9	1K9	TCR15AGADJ	Adjustable	XKX
TCR15AG20*	2.0	2K0			

\* Please contact your local Toshiba representative if you are interested in products with \* sign

#### Top marking (top view)

Example: TCR15AGADJ (Adjustable output)

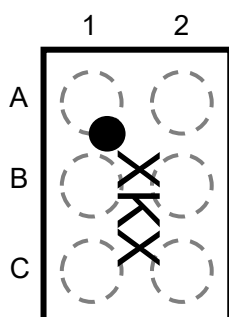

### 8. Block Diagram

Fixed Output voltage

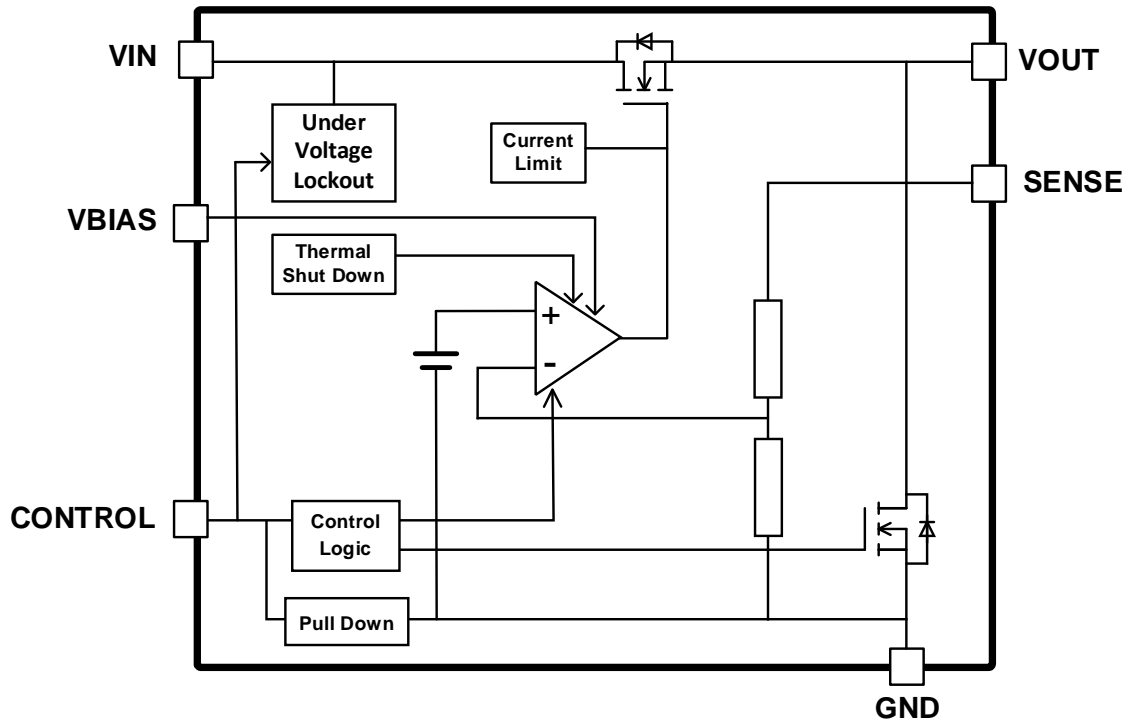

Adjustable Output voltage

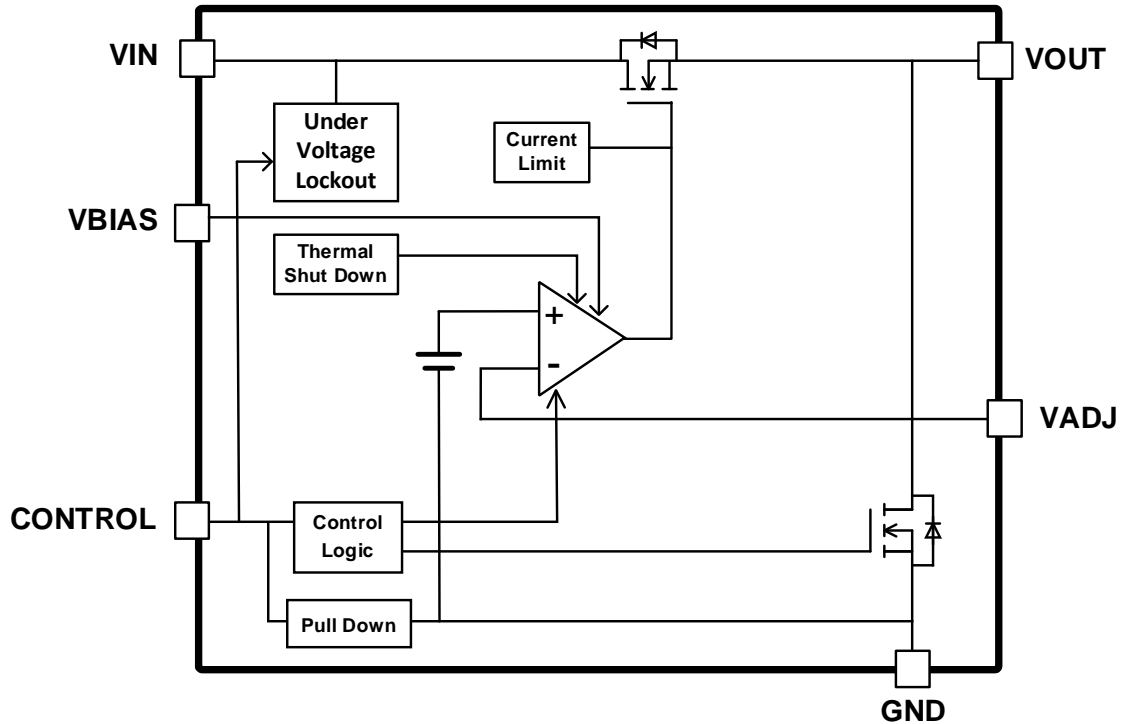

Operation Logic table

Control inputs	Output voltage(V)
High	$V_{OUT}$
Low	0 V (Output discharge)

### 9. Electrical Characteristics

(Unless otherwise specified,  $V_{IN} = V_{OUT} + 0.5\text{ V}$ ,  $I_{OUT} = 50\text{ mA}$ ,  $C_{IN} = 4.7\text{ }\mu\text{F}$ ,  $C_{BIAS} = 1.0\text{ }\mu\text{F}$ ,  $C_{OUT} = 4.7\text{ }\mu\text{F}$ )

Characteristics	Symbol	Test Condition	$T_j = 25^\circ\text{C}$			$T_j = -40\text{ to }85^\circ\text{C}$ (Note 9)		Unit Max	
			Min	Typ.	Max	Min	Typ.		
Output voltage accuracy (Fixed Output voltage)	$V_{OUT}$	$I_{OUT} = 50\text{ mA}$ (Note 5)	$V_{OUT} < 1.8\text{ V}$	-18	—	+18	—	—	mV
			$1.8\text{ V} \leq V_{OUT}$	-1.0	—	+1.0	—	—	%
Adjustable voltage (Adjustable Output voltage)	$V_{ADJ}$	TCR15AGADJ	0.588	0.60	0.612	—	—	V	
Bias voltage	$V_{BIAS}$	$V_{OUT} \leq 1.1\text{ V}$ , $I_{OUT} = 1\text{ mA}$	2.5	—	5.5	2.5	5.5	V	
		$V_{OUT} > 1.1\text{ V}$ , $I_{OUT} = 1\text{ mA}$	$V_{OUT} + 1.4\text{ V}$	—	5.5	$V_{OUT} + 1.4\text{ V}$	5.5	V	
Input voltage	$V_{IN}$	$I_{OUT} = 0\text{ mA}$ (Note 6)	$V_{OUT} + V_{DO}$	—	$V_{BIAS}$	$V_{OUT} + V_{DO}$	$V_{BIAS}$	V	
Line regulation	Reg·line	$V_{OUT} + 0.5\text{ V} \leq V_{IN} \leq 5.5\text{ V}$ $I_{OUT} = 1\text{ mA}$	—	0	15	—	—	mV	
Load regulation	Reg·load	$0.01\text{ A} \leq I_{OUT} \leq 1.5\text{ A}$	—	3	—	—	—	mV	
Quiescent current	$I_{B(ON)}$	$I_{OUT} = 0\text{ mA}$ (Note 7)	—	25	—	—	40	$\mu\text{A}$	
ADJ pin current (Adjustable Output voltage)	$I_{ADJ}$	$V_{ADJ} = 0.6\text{ V}$	—	0	0.1	—	—	$\mu\text{A}$	
Stand-by current	$I_{BIAS(OFF)}$	$V_{CT} = 0\text{ V}$ ,	—	0.04	—	—	1	$\mu\text{A}$	
	$I_{IN(OFF)}$	$V_{CT} = 0\text{ V}$	—	0	0.1	—	—	$\mu\text{A}$	
Control pull down current	$I_{CT}$	—	—	0.03	—	—	—	$\mu\text{A}$	
Dropout voltage	$V_{DO}$	$I_{OUT} = 1.5\text{ A}$ , $V_{BIAS} = 3.3\text{ V}$ (Note 8)	—	120	—	—	216	mV	
Under voltage lockout	$V_{UVLO}$	$V_{IN}$ voltage	—	0.5	—	—	0.65	V	
Temperature coefficient	$T_{CVO}$	$-40^\circ\text{C} \leq T_{opr} \leq 85^\circ\text{C}$	—	60	—	—	—	ppm/ $^\circ\text{C}$	
Output noise voltage	$V_{NO}$	$V_{BIAS} = 3.3\text{ V}$ , $V_{IN} = V_{OUT} + 1\text{ V}$ $I_{OUT} = 10\text{ mA}$ , $V_{OUT} = 0.9\text{ V}$ $10\text{ Hz} \leq f \leq 100\text{ kHz}$ , $T_a = 25^\circ\text{C}$	—	52	—	—	—	$\mu\text{V}_{rms}$	
Ripple rejection ratio	R.R.( $V_{IN}$ )	$V_{BIAS} = 3.3\text{ V}$ , $V_{IN} = V_{OUT} + 1\text{ V}$ $I_{OUT} = 10\text{ mA}$ , $V_{OUT} = 0.9\text{ V}$ $f = 1\text{ kHz}$ , $V_{IN\text{ Ripple}} = 200\text{ mV}_{p-p}$ $T_a = 25^\circ\text{C}$ , $C_{OUT} = 4.7\text{ }\mu\text{F}$	—	95	—	—	—	dB	
	R.R.( $V_{BIAS}$ )	$V_{BIAS} = 3.3\text{ V}$ , $V_{IN} = V_{OUT} + 1\text{ V}$ $I_{OUT} = 10\text{ mA}$ , $V_{OUT} = 0.9\text{ V}$ $f = 1\text{ kHz}$ , $V_{BIAS\text{ Ripple}} = 200\text{ mV}_{p-p}$ $T_a = 25^\circ\text{C}$ , $C_{OUT} = 4.7\text{ }\mu\text{F}$	—	60	—	—	—	dB	
Load transient response	$\Delta V_{OUT}$	$I_{OUT} = 0.01\text{ A} \rightarrow 1.5\text{ A}$	—	-100	—	—	—	mV	
		$I_{OUT} = 1.5\text{ A} \rightarrow 0.01\text{ A}$	—	+115	—	—	—	mV	
Control voltage (ON)	$V_{CT(ON)}$	—	1.0	—	5.5	1.0	5.5	V	
Control voltage (OFF)	$V_{CT(OFF)}$	—	0	—	0.4	0	0.4	V	
Output discharge on resistance	$R_{SD}$	—	—	10	—	—	—	$\Omega$	

Note 5: Stable state with fixed  $I_{OUT}$  condition.

Note 6: Please refer to Dropout Voltage (Page 7) and use it within Absolute Maximum Ratings Junction temperature and Operation Temperature Ranges.

Note 7: Control pull down current and external resistors current not included in this parameter.

Note 8: This parameter is tested at  $V_{OUT} = 0.9\text{ V}$  for Adjustable output.  
For other voltage, please refer to Dropout Voltage (Page 7).

Dropout voltage  $V_{DO} = V_{IN1} - (V_{OUT1} - 100\text{ mV})$ .

$V_{OUT1}$  is the output voltage when  $V_{IN} = V_{OUT} + 0.5\text{ V}$ .  $V_{IN1}$  is the input voltage at which the output voltage becomes 100 mV drop of  $V_{OUT1}$  after gradually decreasing the input voltage

Note 9:  $T_j = -40$  to  $85\text{ }^\circ\text{C}$ . This parameter is warranted by design.

## 10. Dropout voltage table

( $C_{IN} = 4.7\text{ }\mu\text{F}$ ,  $C_{BIAS} = 1.0\text{ }\mu\text{F}$ ,  $C_{OUT} = 4.7\text{ }\mu\text{F}$ ,  $T_j = 25^\circ\text{C}$ )

Output voltages	$V_{BIAS}$ input voltage	$I_{OUT} = 1000\text{ mA}$			$I_{OUT} = 1500\text{ mA}$			Unit
		Min	Typ.	Max (Note 10)	Min	Typ.	Max (Note 10)	
$0.6\text{ V} \leq V_{OUT} < 0.7\text{ V}$	3.3 V	—	73	133	—	110	199	mV
$0.7\text{ V} \leq V_{OUT} < 0.8\text{ V}$	3.3 V	—	75	135	—	112	203	mV
$0.8\text{ V} \leq V_{OUT} < 0.9\text{ V}$	3.3 V	—	77	139	—	115	208	mV
$0.9\text{ V} \leq V_{OUT} < 1.0\text{ V}$	3.3 V	—	80	144	—	120	216	mV
$1.0\text{ V} \leq V_{OUT} < 1.1\text{ V}$	3.3 V	—	83	152	—	125	228	mV
$1.1\text{ V} \leq V_{OUT} < 1.2\text{ V}$	3.3 V	—	89	160	—	134	240	mV
$1.2\text{ V} \leq V_{OUT} < 1.3\text{ V}$	3.3 V	—	94	171	—	141	257	mV
1.3 V	3.3 V	—	99	183	—	149	274	mV
1.4 V	3.3 V	—	107	197	—	161	295	mV
1.5 V	3.3 V	—	116	217	—	174	325	mV
$1.6\text{ V} \leq V_{OUT} \leq 3.6\text{ V}$	$V_{OUT} + 1.7\text{ V}$	—	118	320	—	193	480	mV

Note 10:  $T_j = -40$  to  $85\text{ }^\circ\text{C}$ . This parameter is warranted by design.

### 11. Application Note

#### 11.1. Recommended Application Circuit

Fixed Output Voltage

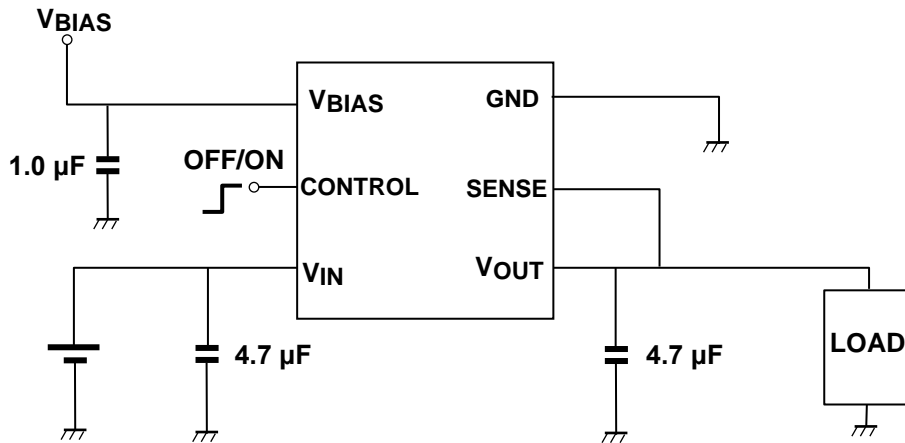

Adjustable Output Voltage

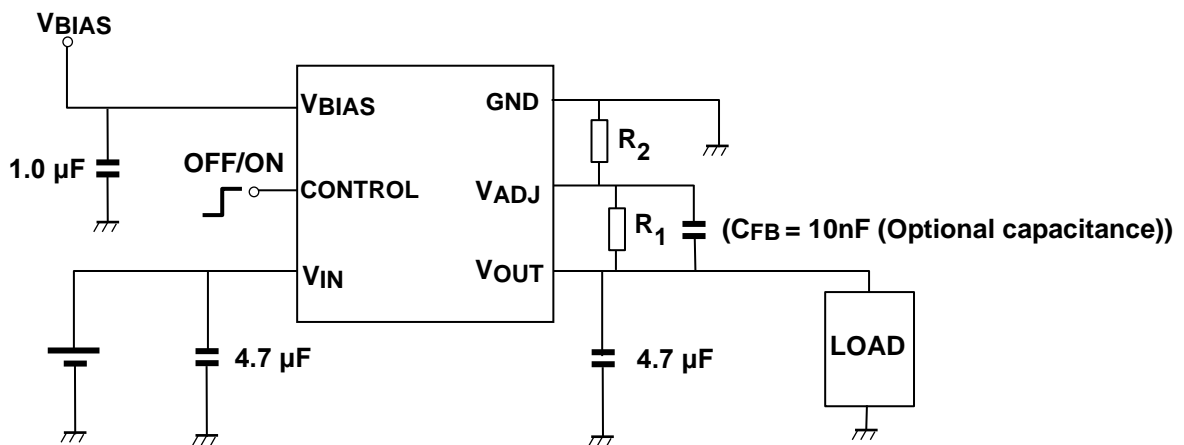

Adjustable Output Voltage ( $V_{OUT} = 0.6\text{ V} : R_1 = 0\ \Omega, R_2 < 4\ \text{M}\Omega$ )

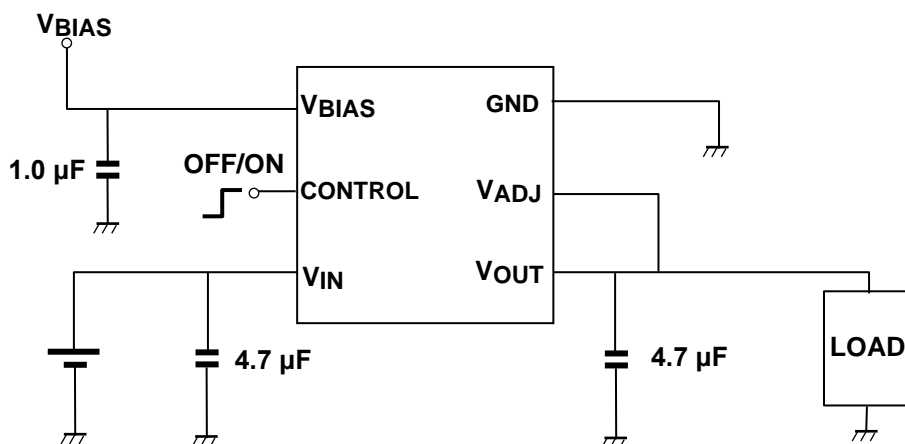



The figure previous page shows the recommended configuration for using a Low-Dropout regulator. Insert a capacitor at VIN, VOUT and VBIAS pins for stable input/output operation. (Ceramic capacitors can be used).

Connect a capacitor with a capacitance value as much as 4.7µF or more between VIN and GND pin and 1.0 µF or more between VBIAS and GND, and as close as possible to the pins. But simple usage of large input capacitance is known to form unwanted LC resonance in combination with input wire inductance. So please check parameter with the actual device and circuit.

C<sub>FB</sub> is optional capacitance that improve Transient response, Output noise, Oscillation resistance, PSRR and Overshoot. However, it does not necessarily need.

VADJ is the output voltage control pin. Typical VADJ value is 0.6 V. For best performance R1 and R2 should have similar temperature coefficients, otherwise output voltage accuracy will be compromised.

$$V_{OUT} = V_{ADJ} \times \left(1 + \frac{R1}{R2}\right)$$

### 11.2. Reference resistance table

This is reference data. Please check parameter with the actual device and circuit.

TCR15AGAD: VADJ = 0.6 V (typ.).

Output voltage (typ.)	R1	R2
0.6 V	0 Ω	< 4 MΩ
0.65 V	2 kΩ	24 kΩ
0.7 V	4 kΩ	24 kΩ
0.8 V	8 kΩ	24 kΩ
0.9 V	12 kΩ	24 kΩ
1.0 V	16 kΩ	24 kΩ
1.1 V	20 kΩ	24 kΩ
1.2 V	24 kΩ	24 kΩ
1.3 V	28 kΩ	24 kΩ
1.8 V	48 kΩ	24 kΩ
2.5 V	76 kΩ	24 kΩ
3.0 V	96 kΩ	24 kΩ
3.3 V	108 kΩ	24 kΩ
3.6 V	120 kΩ	24 kΩ

### 11.3. Power Dissipation

Board-mounted power dissipation ratings for TCR15AG series are available in the Absolute Maximum Ratings table.

Power dissipation is measured on the board condition shown below.

[The Board Condition]

Board material: Glass epoxy (FR4)

Board dimension: 40 mm x 40 mm (4layer), t=1.8 mm

Metal pattern ratio: approximately 70% each layer

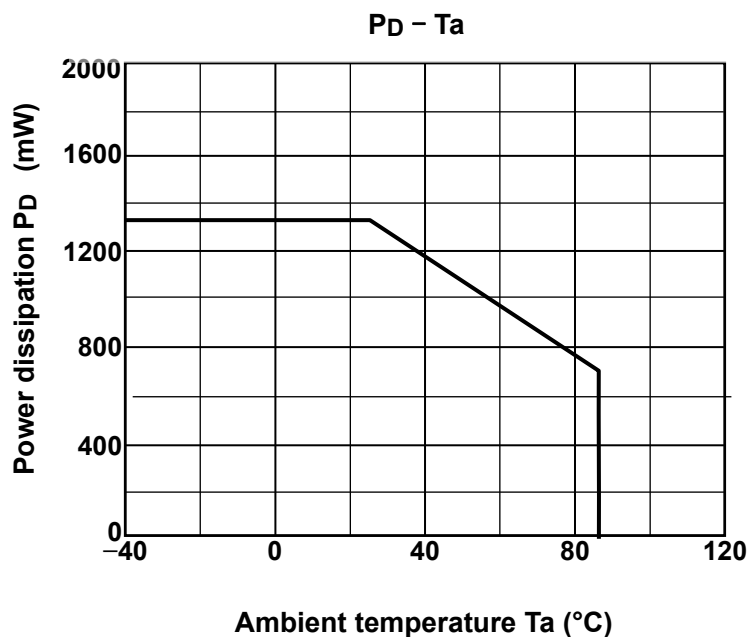

Please allow sufficient margin when designing a board pattern to fit the expected power dissipation. Also take into consideration the ambient temperature, input voltage, output current etc. and applying the appropriate derating for allowable power dissipation during operation.

## 11.4. Attention in Use

- **Capacitors (Output, Input, and Bias Capacitor)**  
Ceramic capacitors can be used for these devices. However, because of the type of the capacitors, there might be unexpected thermal features. Please consider application condition for selecting capacitors. And Toshiba recommend the ESR of ceramic capacitor is under 1.0  $\Omega$ . For stable operation, please use over 4.7  $\mu\text{F}$  Input capacitor, 1.0  $\mu\text{F}$  Bias capacitor and 4.7  $\mu\text{F}$  output ceramic capacitor.
- **Mounting**  
The long distance between IC and each capacitor might affect phase assurance by impedance in wire and inductor. For stable power supply, output capacitor need to mount near IC as much as possible. Also VIN and GND pattern need to be large and make the wire impedance small as possible.
- **Permissible Loss**  
Please have enough design patterns for expected maximum permissible loss. And under consideration of surrounding temperature, input voltage, and output current etc, we recommend proper dissipation ratings for maximum permissible loss; in general maximum dissipation rating is 70 to 80 percent.
- **Overcurrent Protection and Thermal shutdown**  
Overcurrent protection and Thermal shutdown are designed in these products, but these are not designed to constantly ensure the suppression of the device within operation limits. Depending on the condition during actual usage, it could affect the electrical characteristic specification and reliability. Also note that if output pins and GND pins are not completely shorted out, these products might be break down.  
When using these products, please read through and understand the concept of dissipation for absolute maximum ratings from the above mention or our 'Semiconductor Reliability Handbook'. Then use these products under absolute maximum ratings in any condition. Furthermore, Toshiba recommend inserting failsafe system into the design.
- **Adjustable output voltage type**  
TCR15AGADJ is adjustable output voltage type. VADJ is the output voltage control pin, please refer to recommended application circuit and reference resistance table. Please select the tolerance of the resistance value in accordance by the system. In addition, please assemble R1 and R2 to minimize common impedance. For VADJ assembly, please design PCB pattern as short as possible to avoid noise effect.
- **SENSE pin**  
In fixed output voltage type, please connect SENSE pin to V<sub>OUT</sub> pin. Voltage drop of wiring resistance between V<sub>OUT</sub> pin and load is compensated by connecting V<sub>OUT</sub> of near load.

### 12. Representative Typical Characteristics

#### 12.1. Output Voltage vs. Output Current

( $V_{IN} = V_{OUT} + 0.5 \text{ V}$ ,  $V_{BIAS} = 3.3 \text{ V}$  or  $V_{OUT} + 1.7 \text{ V}$  (whichever is greater),  $T_a = 25^\circ\text{C}$ )

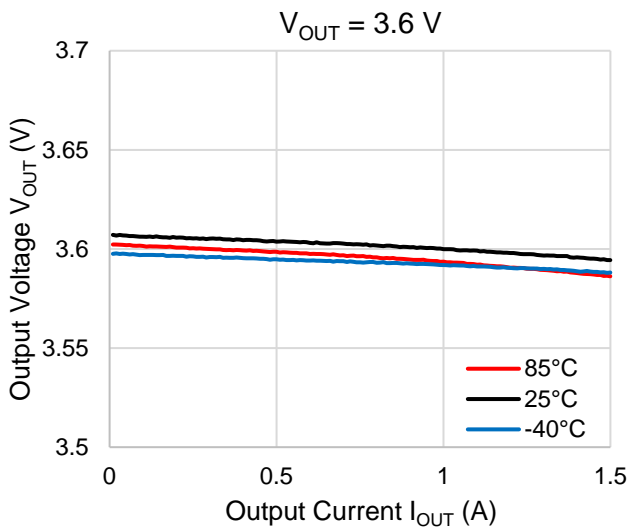
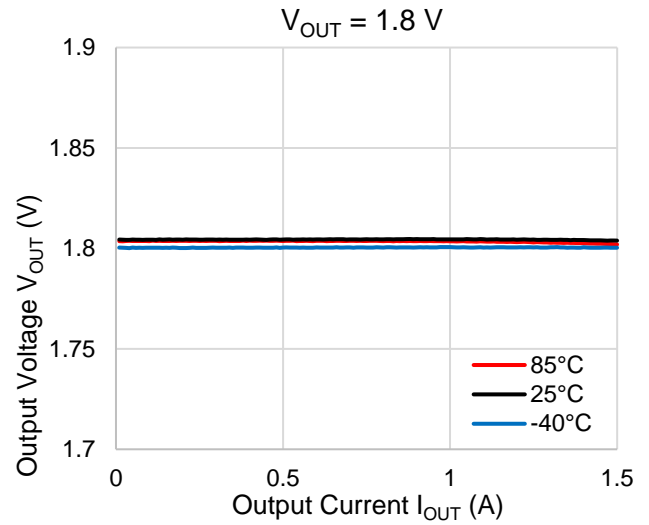
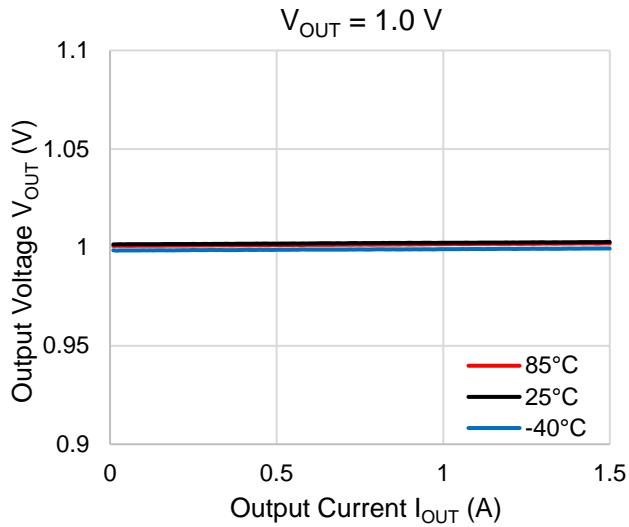

Note: The above characteristics curves are presented for reference only and not guaranteed by production test, unless otherwise noted.

### 12.2. Output Voltage vs. Input Voltage

( $C_{BIAS} = 1.0 \mu\text{F}$ ,  $C_{IN} = 4.7 \mu\text{F}$ ,  $C_{OUT} = 4.7 \mu\text{F}$ ,  $V_{BIAS} = 3.3 \text{ V}$  or  $V_{OUT} + 1.7 \text{ V}$  (whichever is greater),  $I_{OUT} = 1 \text{ A}$ ,  $T_a = 25^\circ\text{C}$ )

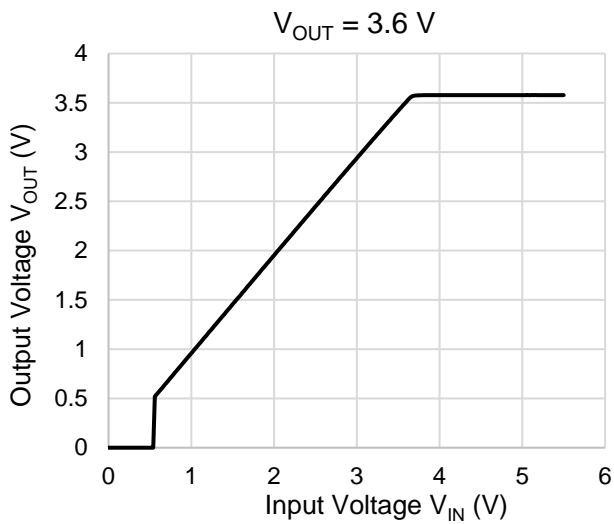
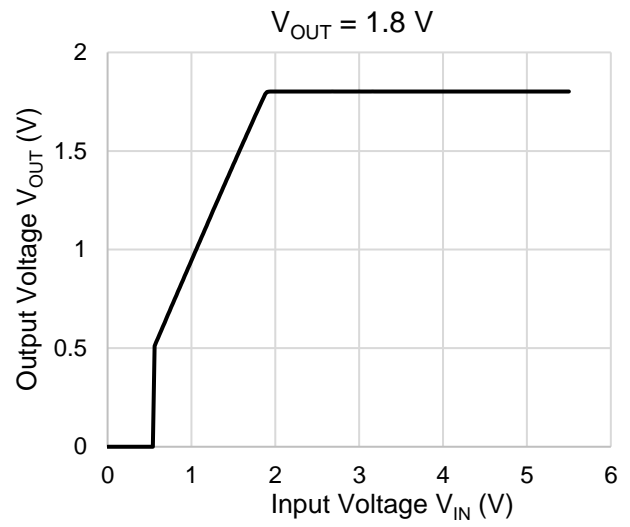
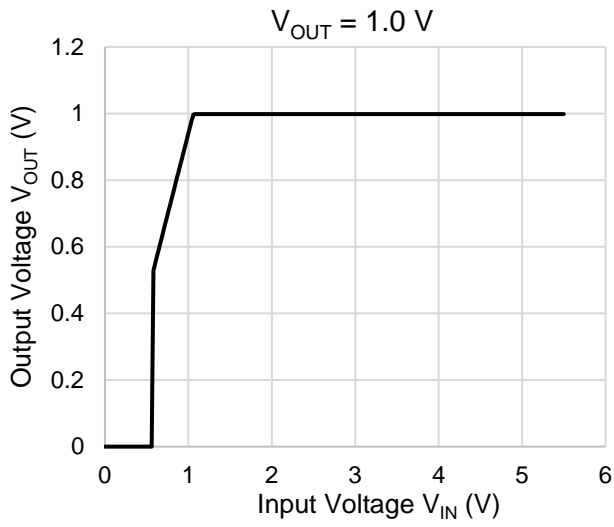

Note: The above characteristics curves are presented for reference only and not guaranteed by production test, unless otherwise noted.

### 12.3. Dropout Voltage vs. Output Current ( $V_{BIAS} = 3.3\text{ V}$ or $V_{OUT} + 1.7\text{ V}$ (whichever is greater))

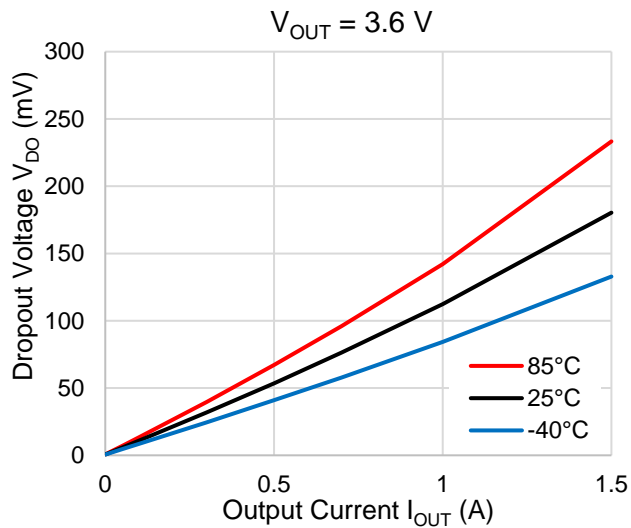
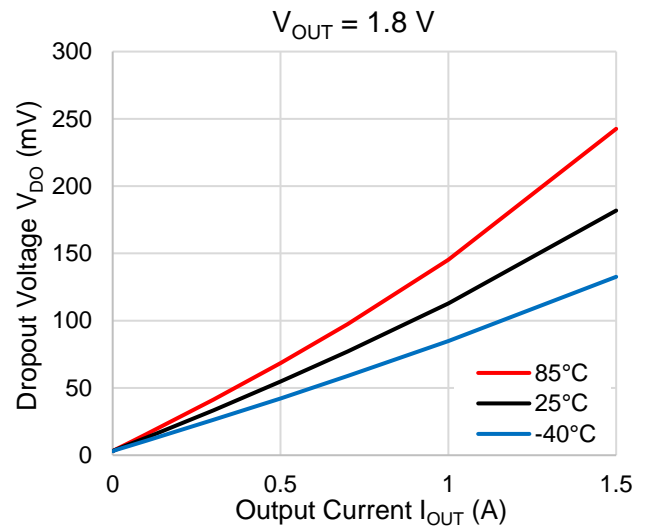
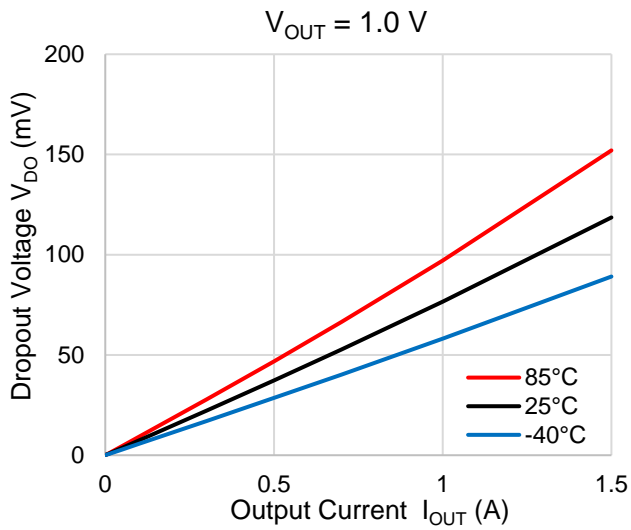

Note: The above characteristics curves are presented for reference only and not guaranteed by production test, unless otherwise noted.

### 12.4. Dropout Voltage vs. Bias Voltage

( $V_{IN} = V_{OUT} + 0.5 \text{ V}$ ,  $I_{OUT} = 1 \text{ A}$ ,  $T_a = 25^\circ\text{C}$ )

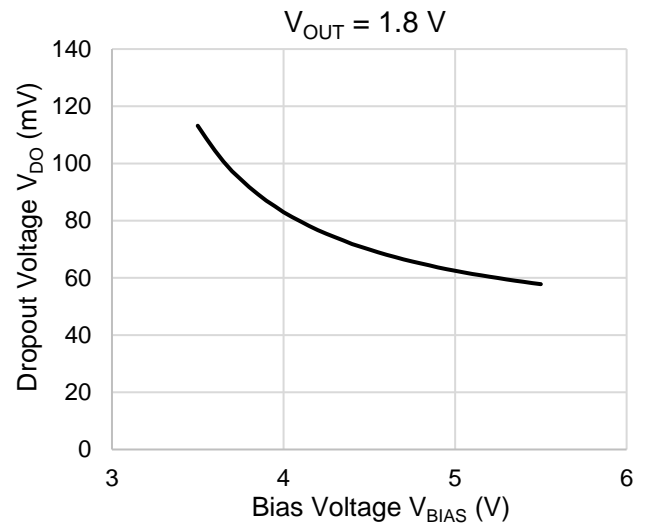
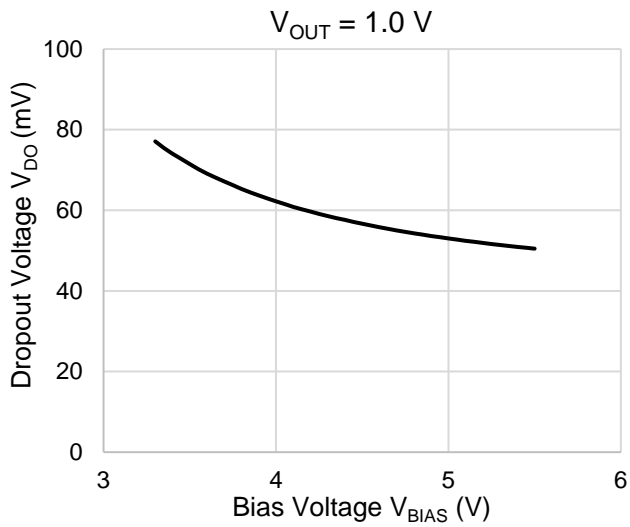

### 12.5. Bias Current vs. Output Current

( $V_{IN} = V_{OUT} + 0.5 \text{ V}$ ,  $V_{BIAS} = 3.3 \text{ V}$  ( $V_{OUT} = 1.0 \text{ V}$ ) or  $3.5 \text{ V}$  ( $V_{OUT} = 1.8 \text{ V}$ ),  $T_a = 25^\circ\text{C}$ )

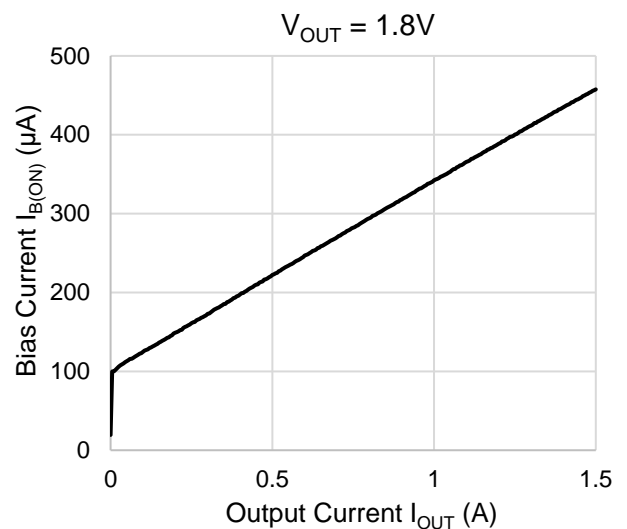
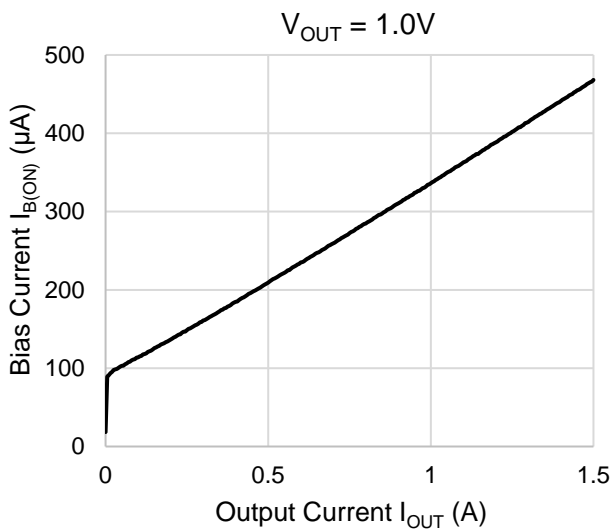

Note: The above characteristics curves are presented for reference only and not guaranteed by production test, unless otherwise noted.

### 12.6. Bias Current vs. Bias Voltage

( $V_{IN} = V_{OUT} + 0.5\text{ V}$ ,  $I_{OUT} = 0\text{ mA}$ ,  $T_a = 25^\circ\text{C}$ )

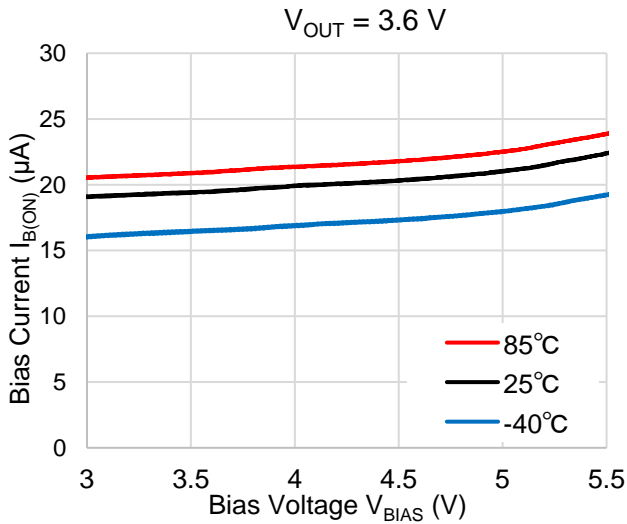
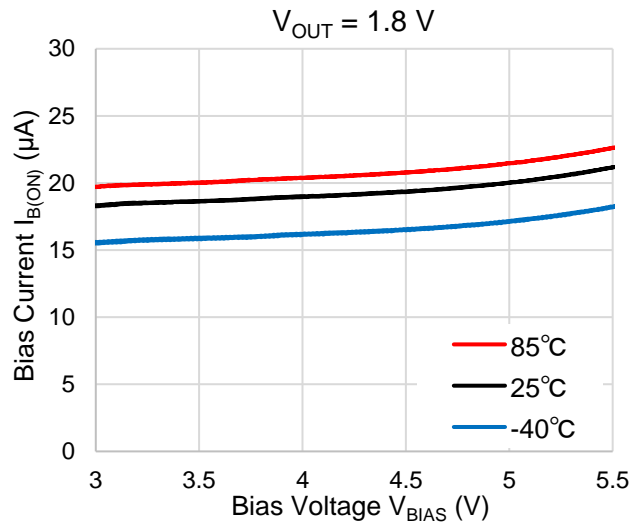
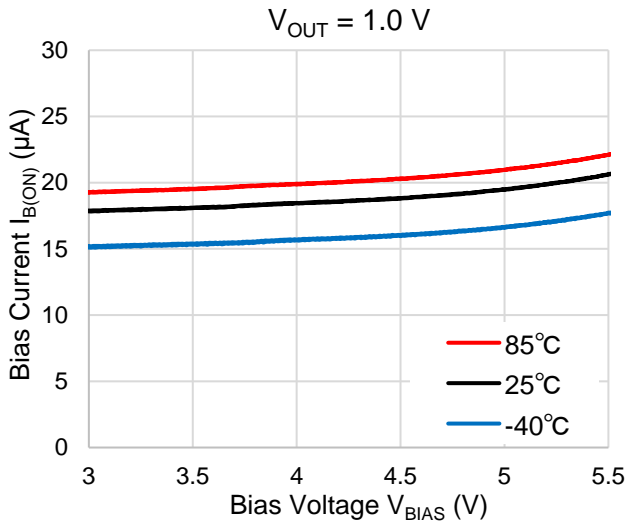

Note: The above characteristics curves are presented for reference only and not guaranteed by production test, unless otherwise noted.



### 12.7. Output Current Limit

( $V_{IN} = V_{OUT} + 1.0\text{ V}$ ,  $V_{BIAS} = 3.3\text{ V}$  or  $V_{OUT} + 1.7\text{ V}$  (whichever is greater),  $T_a = 25^\circ\text{C}$ , Pulse measurement)

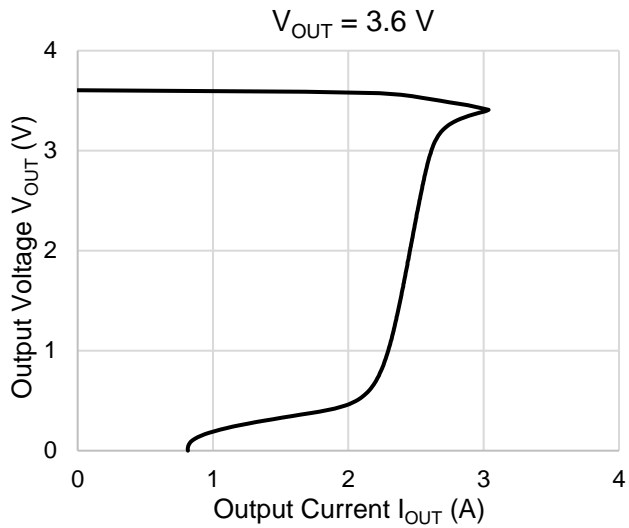
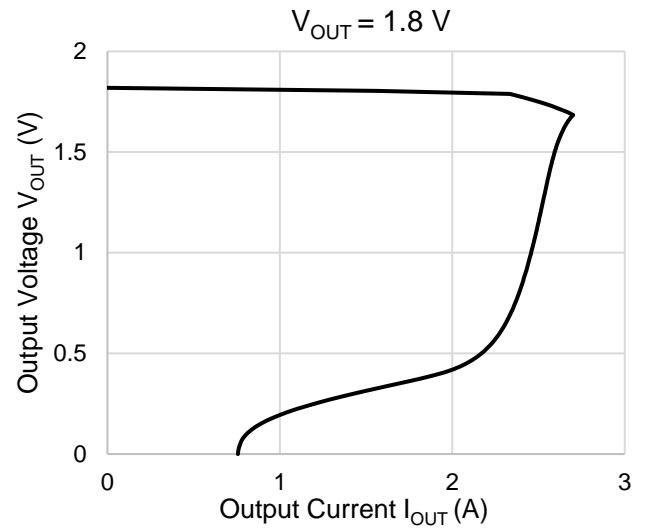
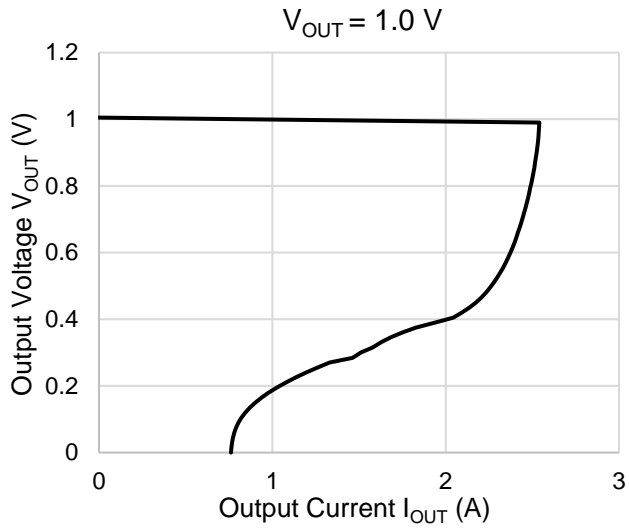

Note: The above characteristics curves are presented for reference only and not guaranteed by production test, unless otherwise noted.

### 12.8. Input Voltage Ripple rejection Ratio vs. Frequency

( $C_{BIAS} = 1.0 \mu\text{F}$ ,  $C_{IN} = \text{none}$ ,  $C_{OUT} = 4.7 \mu\text{F}$ ,  $V_{IN} = V_{OUT} + 1.0 \text{ V}$ ,  $V_{BIAS} = 3.3 \text{ V}$  or  $V_{OUT} + 1.7\text{V}$  (whichever is greater),  $V_{IN \text{ Ripple}} = 200 \text{ mV}_{p-p}$ ,  $I_{OUT} = 10 \text{ mA}$ ,  $T_a = 25^\circ\text{C}$ )

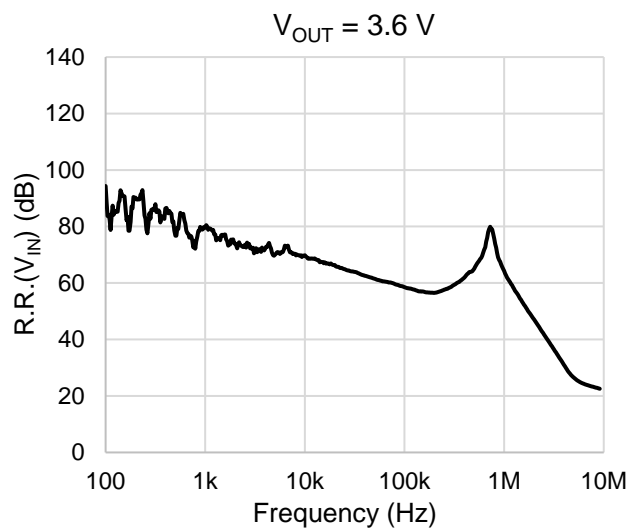
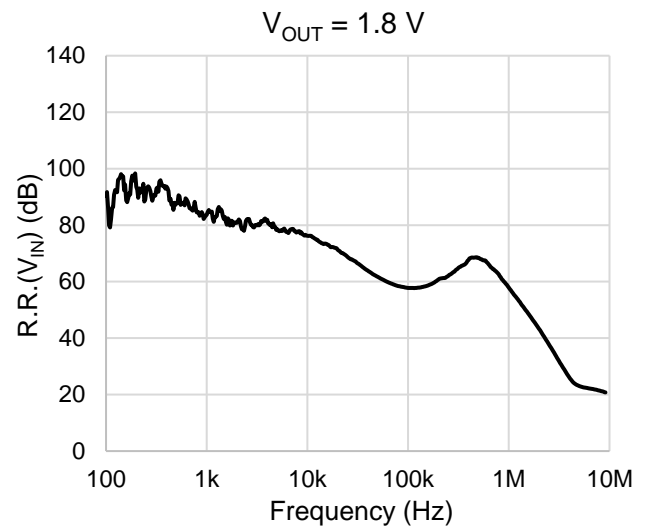
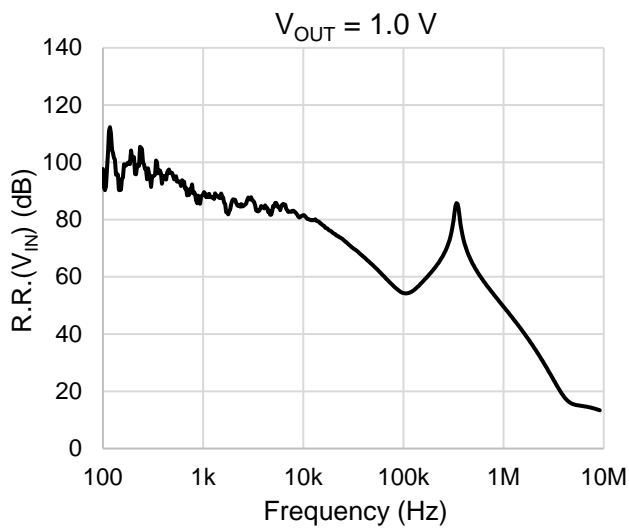

Note: The above characteristics curves are presented for reference only and not guaranteed by production test, unless otherwise noted.

### 12.9. Bias Voltage Ripple rejection Ratio vs. Frequency

( $C_{BIAS}$  = none,  $C_{IN}$  = 4.7  $\mu$ F,  $C_{OUT}$  = 4.7  $\mu$ F,  $V_{IN}$  =  $V_{OUT}$  + 1.0 V,  $V_{BIAS}$  = 3.3 V or  $V_{OUT}$  + 1.7 V (whichever is greater),  $V_{BIAS}$  Ripple = 200 mV<sub>p-p</sub>,  $I_{OUT}$  = 10 mA,  $T_a$  = 25°C)

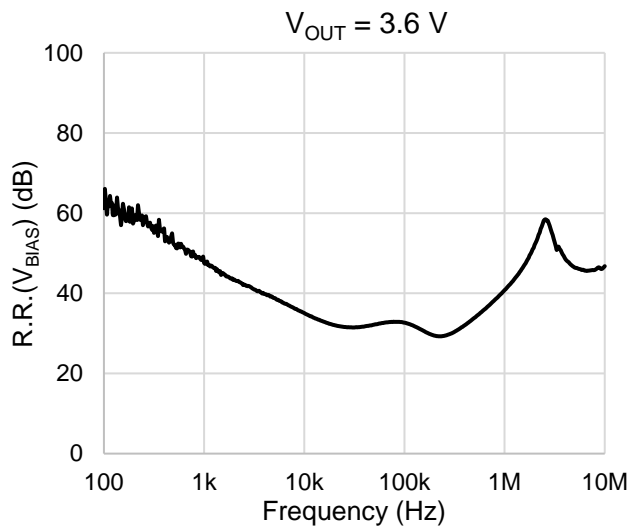
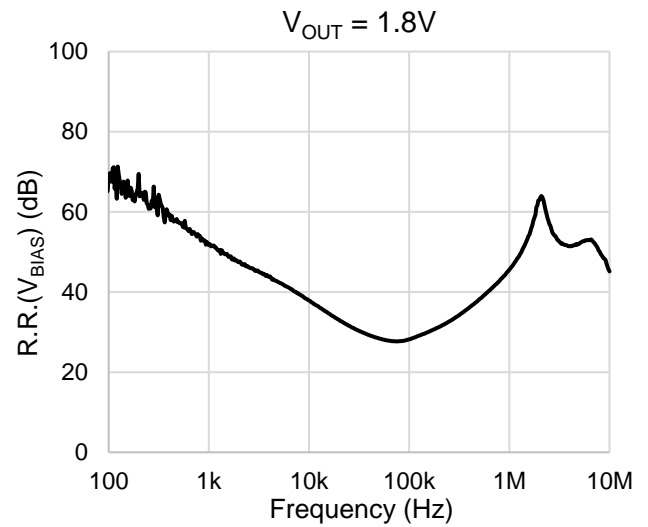
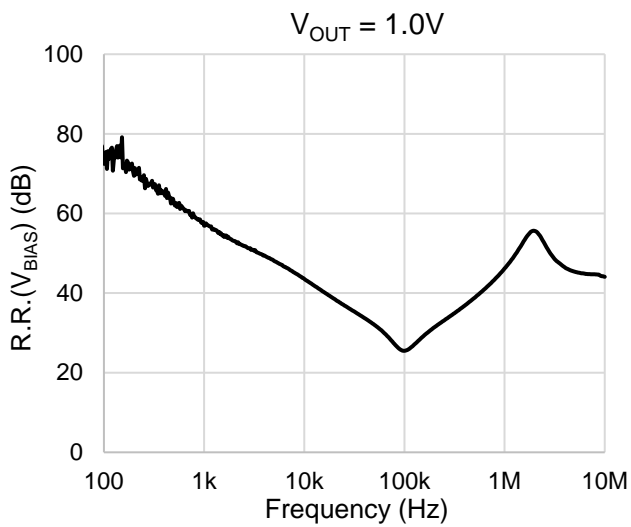

Note: The above characteristics curves are presented for reference only and not guaranteed by production test, unless otherwise noted.

### 12.10. Load Transient Response

( $C_{BIAS} = 1.0 \mu\text{F}$ ,  $C_{IN} = 4.7 \mu\text{F}$ ,  $C_{OUT} = 4.7 \mu\text{F}$ ,  $V_{IN} = V_{OUT} + 0.5 \text{ V}$ ,  $V_{BIAS} = 3.3 \text{ V}$  or  $V_{OUT} + 1.7 \text{ V}$  (whichever is greater),  $I_{OUT} = 10 \text{ mA} \leftrightarrow 1.5 \text{ A}$ ,  $t_r = 1.0 \mu\text{s}$ ,  $t_f = 1.0 \mu\text{s}$ ,  $T_a = 25^\circ\text{C}$ )

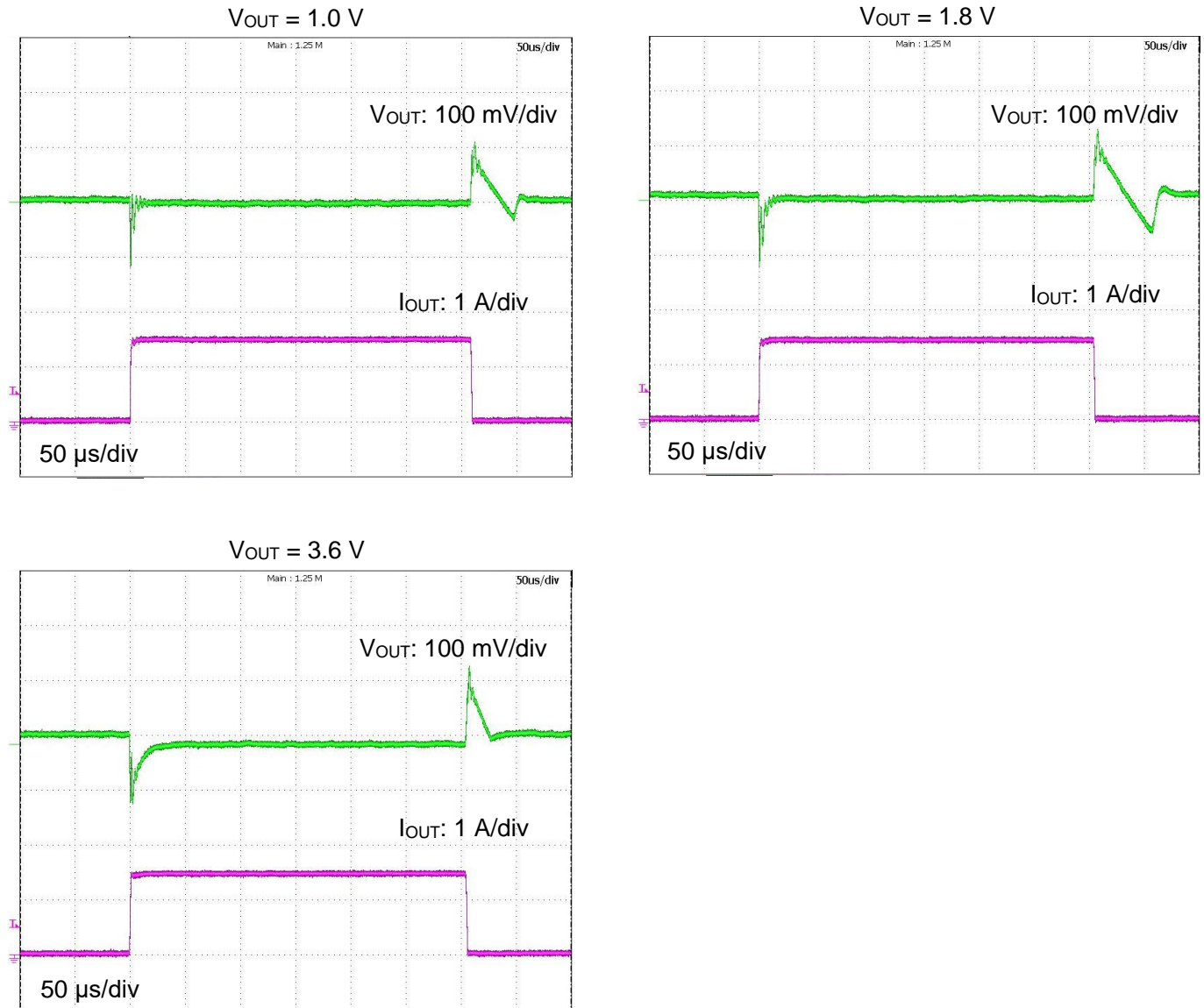

Note: The above characteristics curves are presented for reference only and not guaranteed by production test, unless otherwise noted.

### 12.11. $t_{ON}$ / $t_{OFF}$ Response

( $C_{BIAS} = 1.0 \mu\text{F}$ ,  $C_{IN} = 4.7 \mu\text{F}$ ,  $C_{OUT} = 4.7 \mu\text{F}$ ,  $V_{IN} = V_{OUT} + 0.5 \text{ V}$ ,  $V_{BIAS} = 3.3 \text{ V}$  or  $V_{OUT} + 1.7 \text{ V}$  (whichever is greater),  $V_{CONTROL} = 0 \text{ V} \leftrightarrow 3 \text{ V}$ ,  $T_a = 25^\circ\text{C}$ )

- $I_{OUT} = 0 \text{ mA}$

$V_{OUT} = 1.0 \text{ V}$

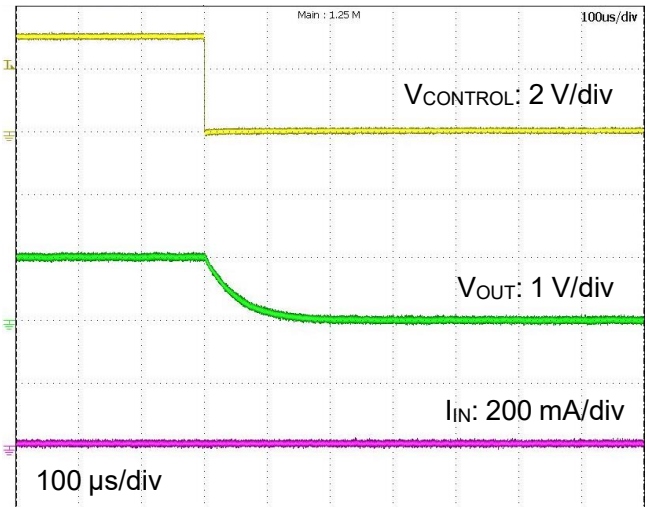
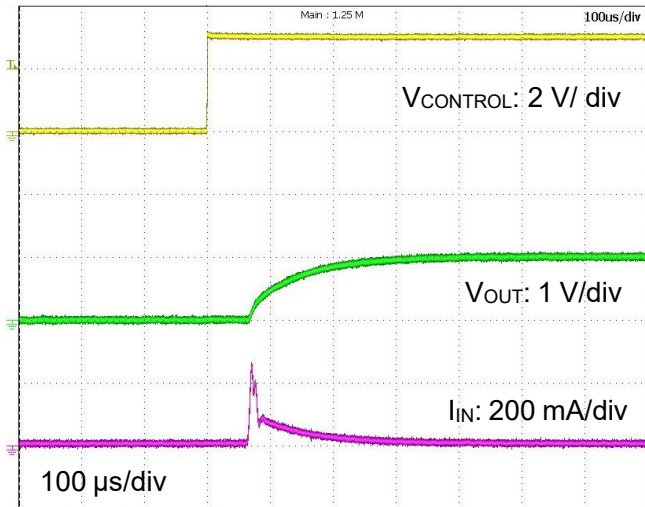

$V_{OUT} = 1.8 \text{ V}$

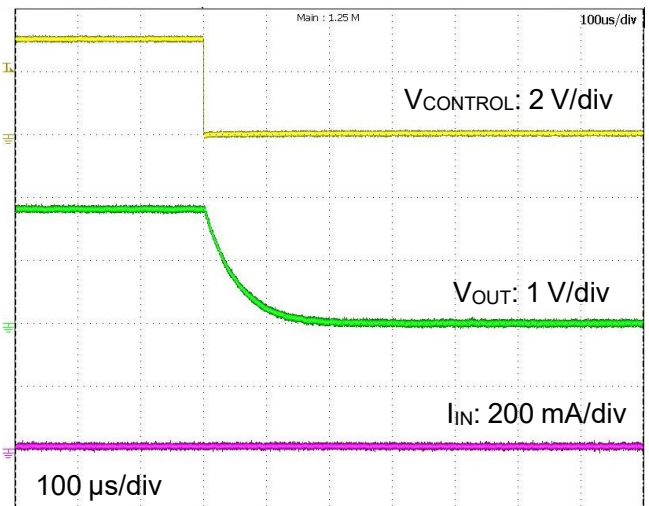
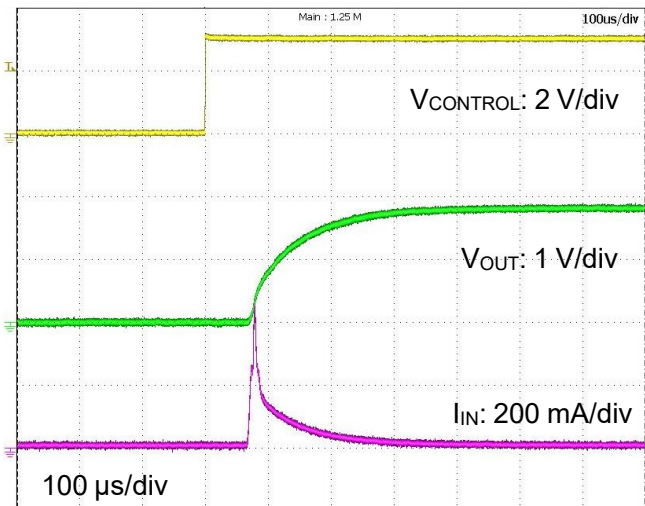

$V_{OUT} = 3.6 \text{ V}$

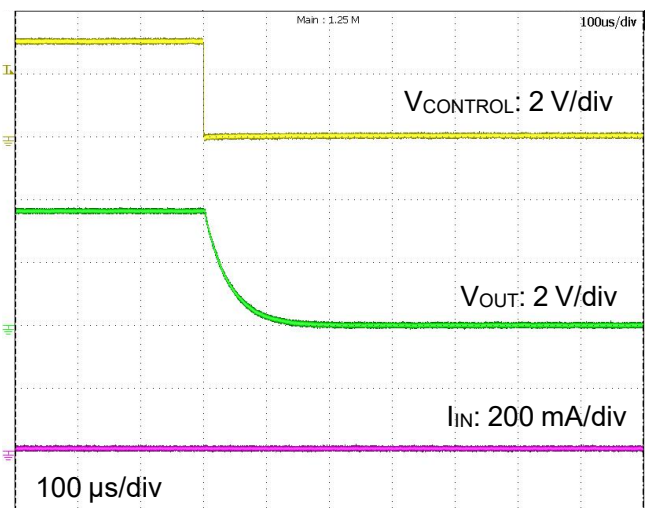
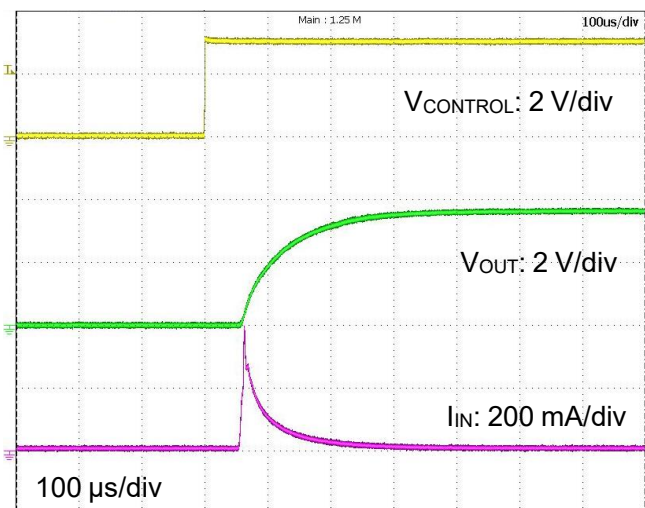

Note: The above characteristics curves are presented for reference only and not guaranteed by production test, unless otherwise noted.

- $I_{OUT} = 1.5\text{ A}$

$V_{OUT} = 1.0\text{ V}$

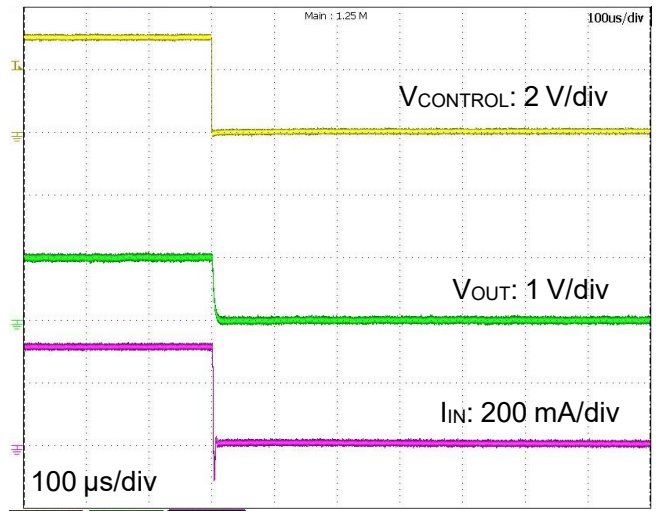
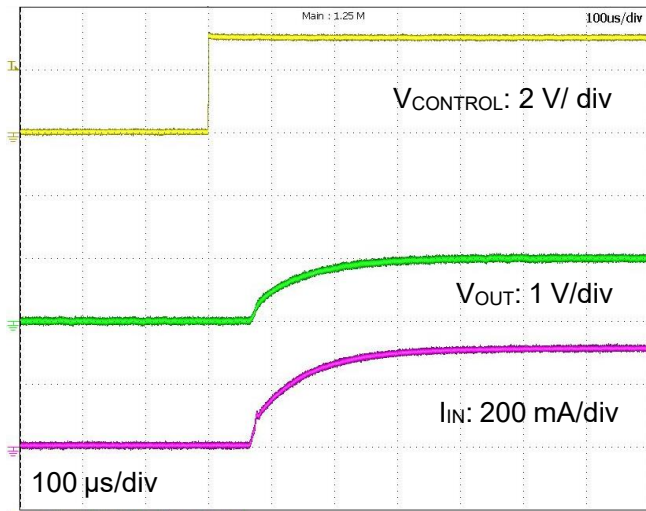

$V_{OUT} = 1.8\text{ V}$

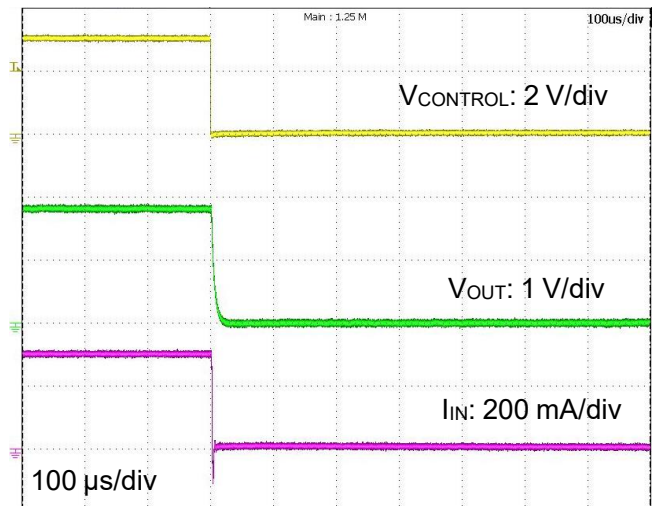
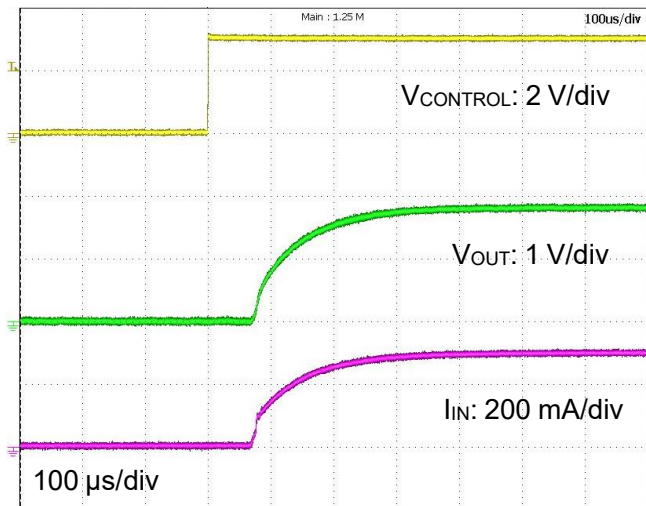

$V_{OUT} = 3.6\text{ V}$

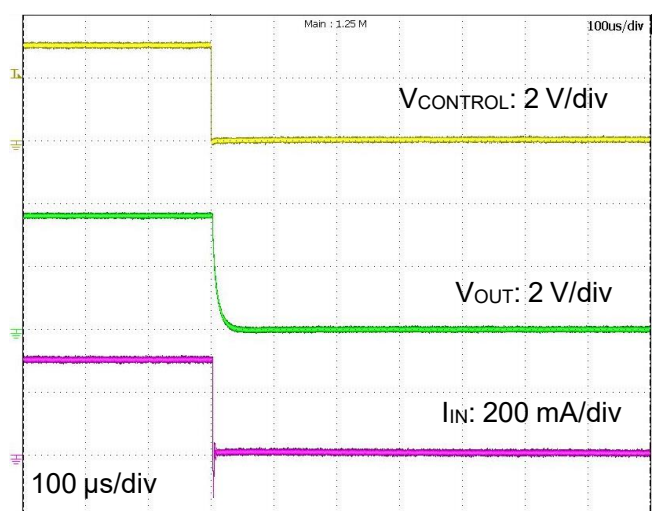
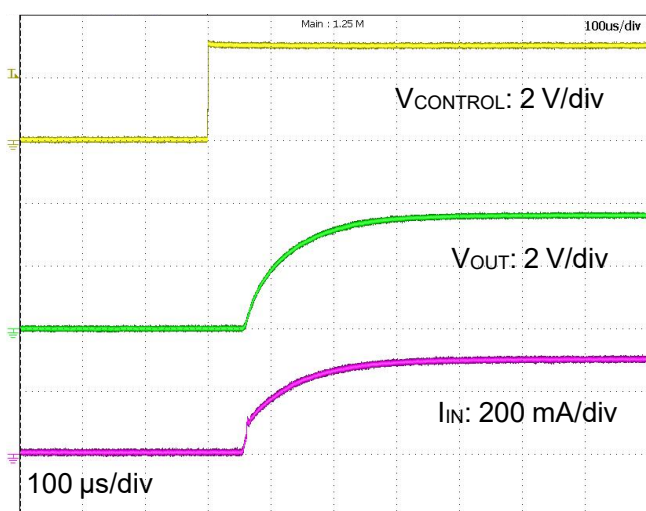

Note: The above characteristics curves are presented for reference only and not guaranteed by production test, unless otherwise noted.

### 13. Package Information

WCSP6F

Unit: mm

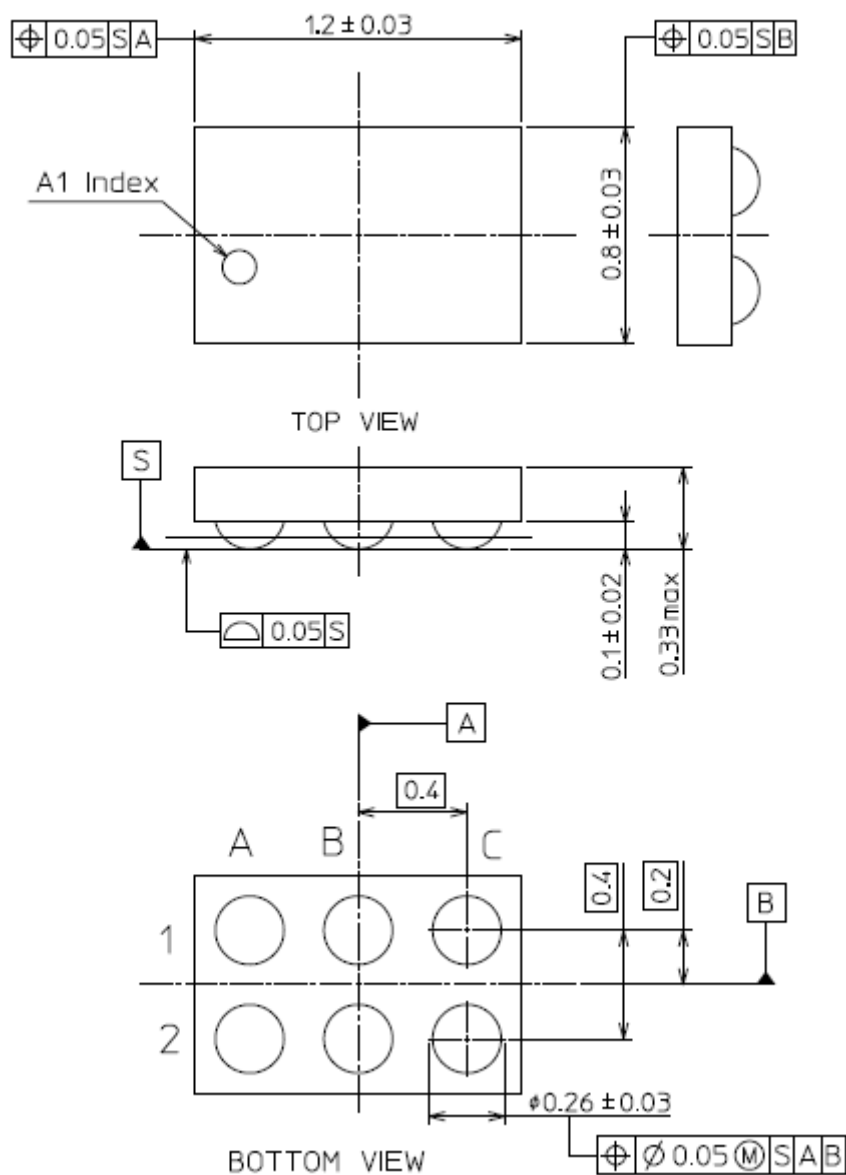

Weight: 0.61 mg (typ.)



### RESTRICTIONS ON PRODUCT USE

Toshiba Corporation and its subsidiaries and affiliates are collectively referred to as "TOSHIBA". Hardware, software and systems described in this document are collectively referred to as "Product".

- TOSHIBA reserves the right to make changes to the information in this document and related Product without notice.
- This document and any information herein may not be reproduced without prior written permission from TOSHIBA. Even with TOSHIBA's written permission, reproduction is permissible only if reproduction is without alteration/omission.
- Though TOSHIBA works continually to improve Product's quality and reliability, Product can malfunction or fail. Customers are responsible for complying with safety standards and for providing adequate designs and safeguards for their hardware, software and systems which minimize risk and avoid situations in which a malfunction or failure of Product could cause loss of human life, bodily injury or damage to property, including data loss or corruption. Before customers use the Product, create designs including the Product, or incorporate the Product into their own applications, customers must also refer to and comply with (a) the latest versions of all relevant TOSHIBA information, including without limitation, this document, the specifications, the data sheets and application notes for Product and the precautions and conditions set forth in the "TOSHIBA Semiconductor Reliability Handbook" and (b) the instructions for the application with which the Product will be used with or for. Customers are solely responsible for all aspects of their own product design or applications, including but not limited to (a) determining the appropriateness of the use of this Product in such design or applications; (b) evaluating and determining the applicability of any information contained in this document, or in charts, diagrams, programs, algorithms, sample application circuits, or any other referenced documents; and (c) validating all operating parameters for such designs and applications. **TOSHIBA ASSUMES NO LIABILITY FOR CUSTOMERS' PRODUCT DESIGN OR APPLICATIONS.**
- **PRODUCT IS NEITHER INTENDED NOR WARRANTED FOR USE IN EQUIPMENTS OR SYSTEMS THAT REQUIRE EXTRAORDINARILY HIGH LEVELS OF QUALITY AND/OR RELIABILITY, AND/OR A MALFUNCTION OR FAILURE OF WHICH MAY CAUSE LOSS OF HUMAN LIFE, BODILY INJURY, SERIOUS PROPERTY DAMAGE AND/OR SERIOUS PUBLIC IMPACT ("UNINTENDED USE").** Except for specific applications as expressly stated in this document, Unintended Use includes, without limitation, equipment used in nuclear facilities, equipment used in the aerospace industry, medical equipment, equipment used for automobiles, trains, ships and other transportation, traffic signaling equipment, equipment used to control combustions or explosions, safety devices, elevators and escalators, devices related to electric power, and equipment used in finance-related fields. **IF YOU USE PRODUCT FOR UNINTENDED USE, TOSHIBA ASSUMES NO LIABILITY FOR PRODUCT.** For details, please contact your TOSHIBA sales representative.
- Do not disassemble, analyze, reverse-engineer, alter, modify, translate or copy Product, whether in whole or in part.
- Product shall not be used for or incorporated into any products or systems whose manufacture, use, or sale is prohibited under any applicable laws or regulations.
- The information contained herein is presented only as guidance for Product use. No responsibility is assumed by TOSHIBA for any infringement of patents or any other intellectual property rights of third parties that may result from the use of Product. No license to any intellectual property right is granted by this document, whether express or implied, by estoppel or otherwise.
- **ABSENT A WRITTEN SIGNED AGREEMENT, EXCEPT AS PROVIDED IN THE RELEVANT TERMS AND CONDITIONS OF SALE FOR PRODUCT, AND TO THE MAXIMUM EXTENT ALLOWABLE BY LAW, TOSHIBA (1) ASSUMES NO LIABILITY WHATSOEVER, INCLUDING WITHOUT LIMITATION, INDIRECT, CONSEQUENTIAL, SPECIAL, OR INCIDENTAL DAMAGES OR LOSS, INCLUDING WITHOUT LIMITATION, LOSS OF PROFITS, LOSS OF OPPORTUNITIES, BUSINESS INTERRUPTION AND LOSS OF DATA, AND (2) DISCLAIMS ANY AND ALL EXPRESS OR IMPLIED WARRANTIES AND CONDITIONS RELATED TO SALE, USE OF PRODUCT, OR INFORMATION, INCLUDING WARRANTIES OR CONDITIONS OF MERCHANTABILITY, FITNESS FOR A PARTICULAR PURPOSE, ACCURACY OF INFORMATION, OR NONINFRINGEMENT.**
- Do not use or otherwise make available Product or related software or technology for any military purposes, including without limitation, for the design, development, use, stockpiling or manufacturing of nuclear, chemical, or biological weapons or missile technology products (mass destruction weapons). Product and related software and technology may be controlled under the applicable export laws and regulations including, without limitation, the Japanese Foreign Exchange and Foreign Trade Law and the U.S. Export Administration Regulations. Export and re-export of Product or related software or technology are strictly prohibited except in compliance with all applicable export laws and regulations.
- Please contact your TOSHIBA sales representative for details as to environmental matters such as the RoHS compatibility of Product. Please use Product in compliance with all applicable laws and regulations that regulate the inclusion or use of controlled substances, including without limitation, the EU RoHS Directive. **TOSHIBA ASSUMES NO LIABILITY FOR DAMAGES OR LOSSES OCCURRING AS A RESULT OF NONCOMPLIANCE WITH APPLICABLE LAWS AND REGULATIONS.**



# Mouser Electronics

Authorized Distributor

Click to View Pricing, Inventory, Delivery & Lifecycle Information:

[Toshiba:](#)

[TCR15AG09,LF](#)