



SBE® 160 / SBX® 175 Connectors

Up to 280 Amps



SBX® and SBE® connectors can integrate up to 8 auxiliary power / signal contacts along with the two primary power circuits. SBE® connectors feature an IEC 60950 touch safe housing molded from a chemical resistant PBT / PC blend resin. SBX® are molded from a rugged PC resin and are rated IP20 per IEC 60529.

• **Meets EN1175:2020**

• **Touch Safe Interface**

Minimizes potential contact with live circuits per IEC 60950 & IEC 60529

• **Up to 8 Last Mate / First Break Auxiliaries**

Enables intelligent power switching, CAN and interlock loop circuitry, as well as power up to 20 amps per pole

• **Color-coded Mechanical Voltage Keys**

Like all Multipole connectors, the SBE® and SBX® offer an easy way to identify circuits and protect against cross mating

SBE® 160 / SBX® 175 ORDERING INFORMATION

SBE® 160 / SBX® 175 Housings

The middle size of SBE®, X, O style housing. SBE® housings are molded from a chemical resistant PBT. SBX® housings are molded from PC. SBE® 160 and SBX® 175 housings of the same Voltage Color-Code can be mated (except yellow) but is not recommended as it invalidates UL approvals. SBX® 175 housings do not meet EN1175:2020 requirements for industrial trucks.

Description	SBE® 160 Part Numbers		SBX® 175 Part Numbers	
Minimum Quantity	100	25	100	25
Yellow	2-8170G4	E6383G1	2-7251G4	6383G1
Orange	2-8170G3	E6382G1	2-7251G3	6382G1
Red	2-8170G5	E6385G1	2-7251G5	6385G1
Gray	2-8170G1	E6380G1	2-7251G1	6380G1
Blue	2-8170G2	E6381G1	2-7251G2	6381G1
Green	2-8170G7	E6390G1	2-7251G7	6390G1
Black	2-8170G14	E6392G1	N/A	N/A

* Yellow SBE® 160 and SBX® 175 housings are NOT intermateable.

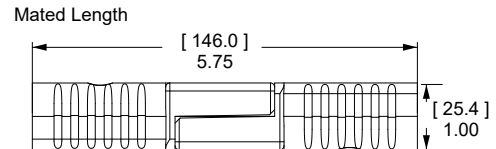
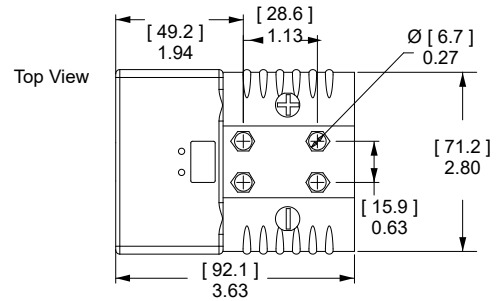

SBE® 160 / SBX® 175 Silver Plated Primary Power Wire Contacts

Use two silver plated contacts per housing for the best electrical performance and durability up to 10,000 mating cycles. See reducing bushings in accessory section for smaller wires.

AWG	mm ²	Loose Piece Part Numbers		Dimensions	
				-A-	
				inches	mm
Minimum Quantity	500	50			
1/0	50	6384G1-BK	6384G1 *	0.44	11.1
2	35	6384G2-BK	6384G2 *	0.38	9.7

* Sold as pairs. 2 parts shipped for every 1 part ordered.

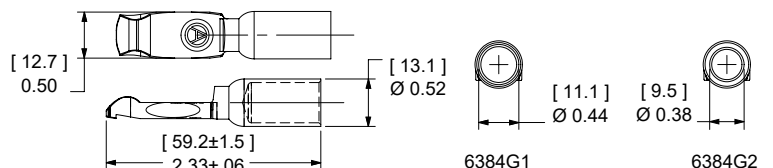

SBE® 160 / SBX® 175 CONNECTOR TEMPERATURE CHARTS - Temperature rise charts are based on a 25°C ambient temperature.

Current - Temperature Derating per IEC 60512-5-2 Test 5B

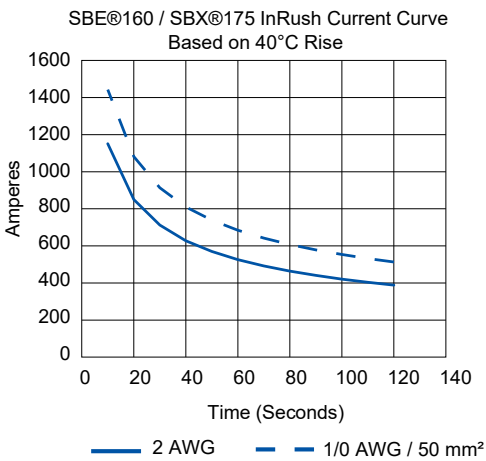
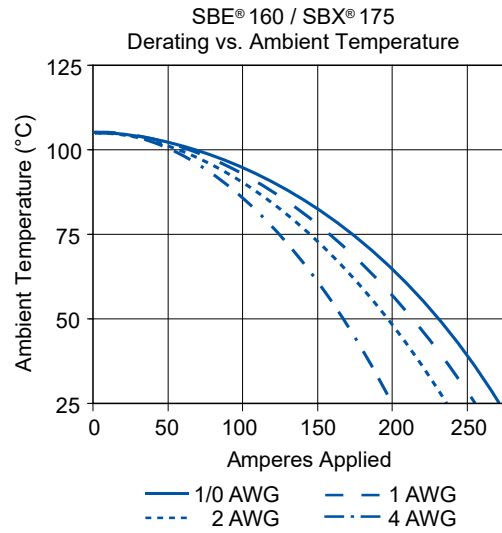
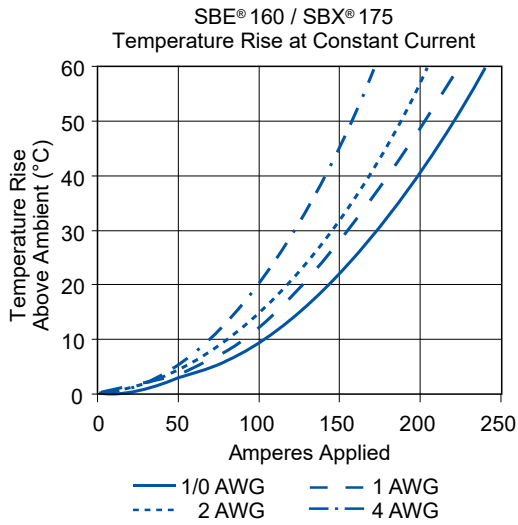

EN1175:2020 Rating	
Rated Current (A)	Cable cross-section (mm²)
160	35

SBE® 160 / SBX® 175 CONNECTOR SPECIFICATIONS

ELECTRICAL SBE® 160 / SBX® 175 Connectors - Up to 280A			
Electrical	SBE® / SBX®		SBE® Only
Current Rating Amperes ¹	USR	CNR	EN1175:2020
Primary Power (1/0)	280	175	160
Powerpole® Auxiliary	20	20	N/A
1x4 Auxiliary (12 AWG)	20	20	N/A
PPMX Auxiliary (20 AWG)	7	5	N/A
Voltage Ratings			
Primary Power Contact	600	600	150
Powerpole® Auxiliary	600	600	150 ⁴
1x4 Auxiliary (12 AWG)	600	600	N/A
Dielectric Withstanding Voltage			
Volts AC	2,200	2,000	2,000
Avg. Mated Contact Resistance ¹			
6" of 1/0 AWG Wire	0.1	0.1	
UL Hot Plug Current Rating Amperes - 250 Cycles at 120V DC			
Power	100	100	
Powerpole® Auxiliary	30	30	
1x4 Auxiliary	5A	5A	

Specifications continued on next page

MECHANICAL		
Wire Size Range	AWG	mm²
Power Contacts	10 to 1/0	5.3 to 53.5
Auxiliary Contacts	24 to 10	0.25 to 5.3
Max. Wire Insulation Diameter	in.	mm
Power Contacts	0.600	15.200
Powerpole® Auxiliary	0.175	4.450
1x4 Auxiliary	0.140	3.600
Operating Temperature ²	°F	°C
SBX® and SBE® Housings	-4° to 221°	-20° to 105°
Mating Cycles No Load by Plating	Silver (Ag)	Gold (Au)
Power Contacts	10,000	
Powerpole® Auxiliary	10,000	
1x4 Auxiliary		10,000
PPMX Auxiliary		5,000
Avg. Mating / Unmating Force	Lbf.	N
Main Connector Housing	30	134
Per Powerpole® Connector	5.00	22.00
Per Contact in 1x4 Auxiliary	0.70	3.00
Per PPMX Housing	4.50	20.00
Min. Contact / Spring Retention Force	Lbf.	N
Power Standard Housing	120	533.7
Powerpole® Housing	25	111
1x4 Auxiliary Housing	10	44.5
PPMX Housing	12	53

MATERIALS

Housing

SBX® and Powerpole® Plastic Resin	Polycarbonate
SBE® and 1x4 Auxiliary Housing	Polycarbonate / PBT Blend
Contact Retention Spring	Stainless Steel

Housing Flammability Rating

UL94	V-0
Glow Wire - SBE® 160 Only	960°C (GWFI) / 850°C (GWIT)
Power & Powerpole® Contact	Silver Plated Copper Alloy

1x4 Auxiliary Contacts

Pin	Copper Alloy, Au Over Ni
Socket	BeCu, Au Over Ni
Socket Body	Copper Alloy, Sn Bright Over Ni
Retention Clip	Stainless Steel

PPMX Contacts

Gold Plated Copper Alloy

Contact Termination Methods

Crimp ³
Hand Solder



NOTE 1: See IEC 60664-1 for working voltage.

NOTE 2: Amp ratings are stated per position and based on all positions being fully loaded.

1 - Based on: 105°C rated or better cable of the largest size. Properly calibrated Anderson Power™ recommended tooling, and a 25°C ambient temperature. UL rating not to exceed the maximum operating temperature. CSA Rating below a 30°C temperature rise.

2 - Limited by the thermal properties of the connector plastic housing.

3 - Use Anderson Power™ recommended tooling only. Alternate tools may adversely affect the performance of our connectors along with UL and CSA recognition.

4 - Voltage capability of SBE® housing is identical to SBX®, but derated to meet EN1175:2020 requirements.

IEC INFORMATION

Connector Series	Configurations	Creepage / Clearance per IEC 60950-1	Material Group
SBE® 160	Unmated	6.1 mm	IIIa
	Mated	11.6 mm	

PROTECTION

Touch Safety Main Connector Housing

IEC 60950	SBE® 160 Only	Pass
IEC 60529	SBE® 160 and SBX® 175	IP20 unmated



ATTRIBUTES	SBE® 160
AMP Rating AC/DC	160 Amp
Voltage Rating AC/DC (Steady State)	600 V AC/DC (Operational)
Breaking Capacity - AMP Rating / Cycles	160 Amp / 10 Cycles
Voltage Rating (Breaking Capacity)	220 VDC
FINGER Safety - Mated / Unmated	IEC 60529 - IP20
Wire Size Tested	50 mm ²
Contact Series Tested	6384G1
Climatic Testing (Cold, Heat & MFG)	IEC 60512 Test -11j, 11i & 11g
Cycle Life	IEC 60512 Test 9a - 5,000 Cycles
Mechanical Strength Impact	IEC 60512-5 @ 29.5 Inches-dropped 8 times
Temperature Range	-20 °C to 105 °C -4 °F to 221 °F

SBE® 160 / SBX® 175 ACCESSORIES

Cable Clamps *

Durable metal clamps adapt to a wide range of cable sizes.

Description	Cable Size		Part Number
	Min / Max Inches O.D.	Min / Max mm O.D.	
Minimum Quantity			25
Cable Clamp Kit	0.62 to 0.22	15.7 to 5.6	945G2

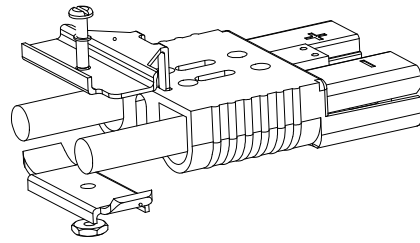

* Torque value 30 (in - lbs) / 3.4 (Nm)

NOTE: For assembly of clamp to housing only

The given wire O.D. information is an estimate. Cable clamps should be evaluated for performance with the actual wire to be used.

Handles *

Handles are made out of durable PC plastic. Hardware to attach to connector body included in kits.

Description	Part Numbers	
Minimum Quantity	100	25
Gray Handle Kit	-	995G1
Red Handle Kit	-	995G3
Handle Only, Gray	3-5074P1	-
Handle Only, Red	3-5074P3	-
Handle Only, Black	3-5074P5	-
Hardware Bag	-	105G8

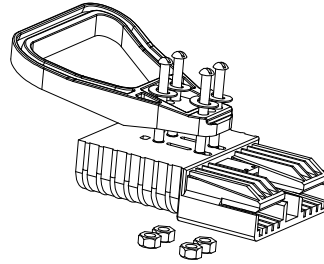

* Torque value 30 (in - lbs) / 3.4 (Nm)

NOTE: For assembly of clamp to housing only

Powerpole® Auxiliary

Powerpole® auxiliary connectors are rated up to 30 amps 600 volts and can be used for auxiliary power, control or sensing. The auxiliary kit includes (1) each black and red Standard Powerpole® housing, (2) contacts, (2) zip cable straps, and (2) retaining pins. (1) Retaining clip can be substituted for (2) retaining pins.

Description	Part Numbers	
Minimum Quantity	200	25
Powerpole® Auxiliary Kit	-	6344
Black Powerpole® Housing	1327G6	-
Red Powerpole® Housing	1327	-
16 to 12 AWG Contact	1331	-

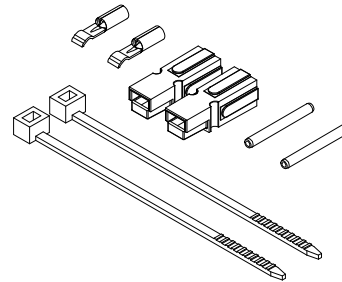

NOTE: Finger proof PP15/45 housings should not be used for auxiliary contacts.

1x4 Auxiliary Connector

The unique 1x4 auxiliary connector allows up to 4 auxiliary circuits up to 20 amps 150 volts each in SBE®, SBO®, & SBX® housings. The genderless design holds two each of the gold plated pin & socket contacts. This innovation allows the very durable and cost effective design of SBE®, O, X connectors to substitute for DIN 43589-1 applications where 4 auxiliary contacts are required. Multiple pin lengths allow the further benefit of sequencing between circuits. (2) Retaining pins or (1) Retaining clip is required to hold the auxiliary housing in place. Auxiliary Kits include (1) Auxiliary Housing, (2) Standard Length Pin Contacts, (2) Socket Contacts, (2) Retaining Pins and (1) Retaining Clip.

Description	AWG	mm²	Part Numbers		
Minimum Quantity			1,000	250	25
1x4 Auxiliary Kit	12	4	-	-	441G3
1x4 Auxiliary Kit	16 to 14	1.5 to 2.5	-	-	441G1
1x4 Auxiliary Kit	20 to 16	0.75 to 1.5	-	-	441G2
1x4 Auxiliary Housing	Contacts Sold Separately		3-5956P1	444G1	-

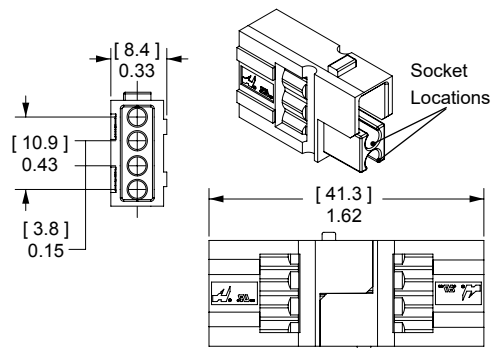

Pin Contacts for 1x4 Auxiliary Connector

Gold plated contacts are available in 4 lengths to allow sequencing of circuits.

Description	AWG	mm ²	Part Numbers	
Minimum Quantity			500	50
Standard Length 7.7 mm	12	2.5	PM16P12S30	PM16P12S30-50
	16 to 14	1.0 to 1.5	PM16P1416S30	PM16P1416S30-50
	20 to 16	0.75 to 1.0	PM16P1620S30	PM16P1620S30-50
	24 to 20	0.50 to 0.75	PM16P2024S30	PM16P2024S30-50
Pre-Mate 9.3 mm	12	2.5	PM16P12A30	-
	16 to 14	1.0 to 1.5	PM16P1416A30	-
	20 to 16	0.75 to 1.0	PM16P1620A30	-
	24 to 20	0.50 to 0.75	PM16P2024A30	-
Post-Mate 6.4 mm	12	2.5	PM16P12C30	-
	16 to 14	1.0 to 1.5	PM16P1416C30	-
	20 to 16	0.75 to 1.0	PM16P1620C30	-
	24 to 20	0.50 to 0.75	PM16P2024C30	-

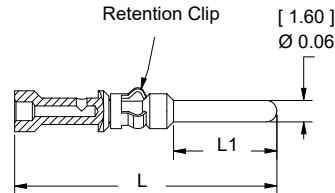

Auxiliary Pin Contact Lengths	- L -		- L1 -	
	in.	mm	in.	mm
Standard Length 7.7 mm	0.77	19.6	0.30	7.7
Pre-Mate 9.3 mm	0.83	21.2	0.37	9.3
Post-Mate 6.4 mm	0.72	18.3	0.25	6.4

Socket Contacts for 1x4 Auxiliary Connector

Selectively gold plated contacts offer low resistance and durability up to 10,000 mating cycles.

Description	AWG	mm ²	Part Numbers	
Minimum Quantity			500	50
Socket Contact	12	2.5	PM16S12S32	PM16S12S32-50
	16 to 14	1.0 to 1.5	PM16S1416S32	PM16S1416S32-50
	20 to 16	0.75 to 1.0	PM16S1620S32	PM16S1620S32-50
	24 to 20	0.50 to 0.75	PM16S2024S32	PM16S2024S32-50

Auxiliary Socket Contacts Crimp Barrel ID

Wire Gauge	in.	mm.
24 to 20	0.04	1.1
20 to 16	0.07	1.7
16 to 14	0.08	2.1
12	0.10	2.6

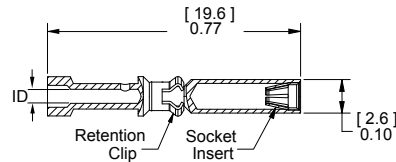

PPMX Auxiliary Connector

The PPMX auxiliary connector allows up to 8 auxiliary circuits to be used in the SBE®, SBO®, & SBX® housings. There are 4 auxiliary circuits per PPMX connector and two PPMX housings fit into the auxiliary port in the main connector housing. Rated up to 7 amps 300 volts per contact, the genderless design holds two each gold plated pin & Socket contacts. This innovation allows the very durable and cost effective design of SBE®, O, X connectors to be used for applications requiring up to 8 battery monitoring or equipment vehicle communication circuits. (2) Retaining pins or (1) Retaining clip is required to hold the auxiliary housing in place.

Auxiliary Kits includes: (1) Auxiliary Housing, (2) Pin Contacts, and (2) Socket Contacts.

Description	AWG	mm ²	Part Numbers		
Minimum Quantity			1,000	100	25
PPMX Auxiliary Kit	24 to 20	0.50 to 0.25	-	4850G6	-
1x4 Auxiliary Housing	Contacts Sold Separately		4827G6-BK	-	4827G6

* No extraction tool required for contact removal.

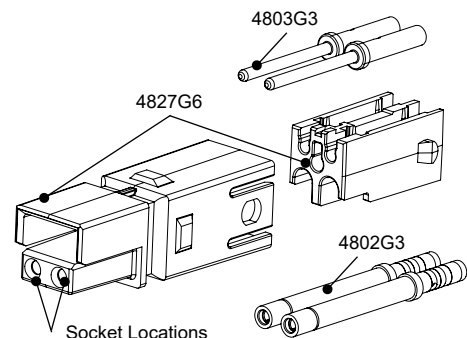

Pin & Socket Contacts for PPMX Auxiliary Connector

Gold plated contacts are ideal for signal or low power use with durability up to 5,000 mating cycles.

Description	AWG	mm ²	Part Numbers	
Minimum Quantity			2,000	50
Pin Contacts	24 to 20	0.50 to 0.25	4803G3-BK	4803G3
Socket Contacts	24 to 20	0.50 to 0.25	4802G3-BK	4802G3

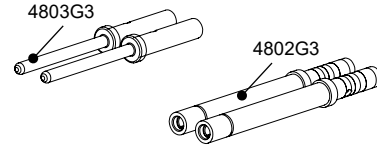

SBE® Air Tubes

Air tubes fit into SBE® housings to allow electrolyte circulation while charging the battery. Genderless tube design allows the same part to be used on both sides. (2) Retaining pins or (2) Spirol pins are required to hold the air tube in place both are included in Air Tube Kit.

Description	Part Numbers	
Minimum Quantity	500	25
Air Tube Kit, Black	-	6396G1
Air Tube Only	3-5798P1	-

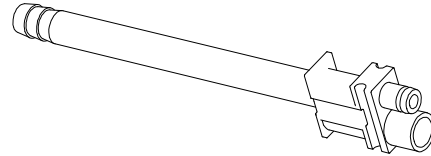

Retaining Clip

Retaining clips can be used in place of two retaining pins to hold auxiliary connectors or air tubes. Allows easier removal of auxiliary modules.

Description	Part Number
Minimum Quantity	100
For SBE® 160 & SBX® 175	2-8675P2

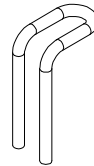

Retaining Pins

Retaining pins are used to hold accessories in the auxiliary port in SBE®, SBO®, & SBX® housings. Dimension "B" is +/- 0.015 in or 0.38 mm.

Description	Part Numbers		Dimensions			
			- A -		- B -	
	inches	mm	inches	mm		
Minimum Quantity	1,000	100				
For SBE® 160 & SBX® 175	110G9-BK	110G9	0.093 / 0.099	2.36 / 2.51	0.85	21.59

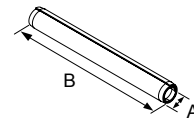

Zip Cable Straps

Zip cable straps are used to secure auxiliary wires to the side of the main power cables.

Description	Part Number
Minimum Quantity	1,000
White	H1835P3

Use cable ties to secure auxiliary contact leads to one of the main cables.

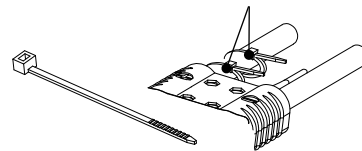

Manual Release - Battery Side *

Works with the Charger / Truck side to ease mating and unmating connectors.

Description	Part Numbers	
Minimum Quantity	88	25
Bracket and Hardware Kit	-	993G2
Battery Bracket Only	111961P2	-
Hardware Bag	-	105G1

* Torque value 30 (in - lbs) / 3.4 (Nm)

*NOTE: For assembly of bracket to housing only

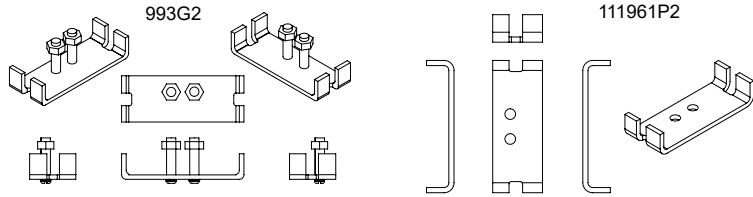

Manual Release - Charger / Truck Side *

Works with the Battery side to ease mating and unmating connectors.

Description	Part Numbers	
Minimum Quantity	60	25
Bracket and Hardware Kit	-	994G2
Bracket / Lever Only	B00511G2	-
Hardware Bag	-	105G1

* Torque value 30 (in - lbs) / 3.4 (Nm)

*NOTE: For assembly of bracket to housing only

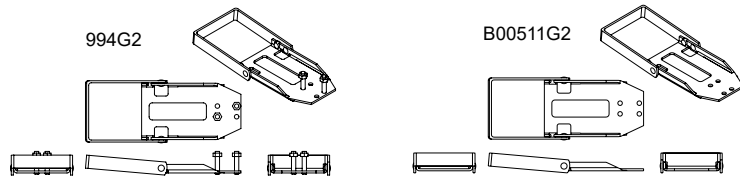

Silver Plated Reducing Bushings: for Use with Contact Part Number 6384G1

Use with contact part number 6384G1-BK to allow a smaller wire to be used with the connector. Electrical capability is derated with smaller wire.

Contacts Barrel Size		Wire Size		Part Numbers				Dimensions - ID -	
AWG	mm ²	AWG	mm ²					inches	mm
Minimum Quantity				1,500	1,000	500	100		
1/0	53.5	1	42.4	-	-	5687-BK	5687	0.39	9.91
1/0	53.5	2	33.6	5690-BK	-	-	5690	0.34	8.64
1/0	53.5	4	21.2	-	5693-BK	-	5693	0.27	6.86
1/0	53.5	6	13.3	-	5663-BK	-	5663	0.22	5.59
1/0	53.5	10 to 8	5.3 - 8.4	5648-BK	-	-	5648	0.19	4.83

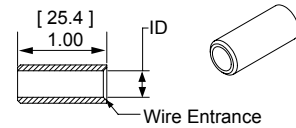

Reducing Bushings: for Use with Contact Part Number 6384G2

Use with contact part number 6384G2-BK to allow a smaller wire to be used with the connector. Electrical capability is derated with smaller wire.

Contact Barrel Size	Wire Size	Part Numbers	
Minimum Quantity		1,000	100
35 mm ²	16 mm ²	5920-BK	5920

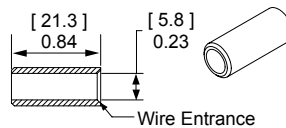

Charger Key

Prevents charger and truck connector halves from engaging

Description	Part Numbers	For Use With	Hardware Kit Includes
Minimum Quantity	25		
Charger Key Kit	6337G1	SBE@160/SBE@320 Connectors	1 Yellow Key 2 Retaining Pins

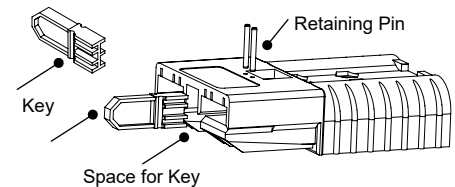

SBO® / SBE® / SBX® - Tooling Information

Wire Size		Loose Piece Part Number	Loose Piece Contact Crimp Tools							
AWG	mm ²	Contacts	Pneumatic Bench Tool	+	Die	+	Locator	Number of Crimps	+	Hand Tools
SBE® 160 / SBX® 175										
1/0	53.5	6384G1	1387G2		1303G13		1304G32	Double		1368 series
2	33.6	6384G2	1387G2		1303G13		1304G32	Double		
1/0 to 2	53.5 to 5	6384G1 & 6384G2	1387G1		1388G3		1389G3	Single		
Powerpole® 15/45 Auxiliary Contacts **										
16 to 20	1.3 to .52	1332	N/A		N/A		N/A	Single		1309G2 or 1309G8
12 to 16	3.3 to 1.3	1331								
PowerMod® 1x4 Auxiliary Contacts										
12 to 24	3.3 to 0.20	All Crimp Pins	TP0001*		N/A		TL0001	Single		TM0001*
		All Crimp Sockets				TL0002	PM1000G1			
PPMX Auxiliary Contacts										
20 to 24	0.50 to 0.25	4803G3	TP0001*		N/A		TL0005	Single		TM0001*
		4802G3				PM1000G1				

Insertion / Extraction Tools

- PM1002G1** - 1 x 4 Auxiliary Contact Insertion Tool - For use with PM contacts and 1x4 auxiliary housing (444G1 housings and 441G kits)
- PM1003G1** - 1 x 4 Auxiliary Contact Extraction Tool - For use with PM contacts and 1x4 auxiliary housing (444G1 housings and 441G kits)
- PM1003GX** - 1x4 Auxiliary Contacts Inspection Tool - For use with PM contacts and 1x4 auxiliary housing (444G1 housings and 441G kits)
- 969P1** - SBE® 160 / SBX® 175 Power Contact Extraction Tool
- 970P1** - SBE® 320 / SBX® 350 Power Contact Extraction Tool

* TP0001 and TM0001 tools require locators to properly position contacts.

** See Powerpole® family tooling chart for other Powerpole® contacts

The auxiliary contacts used with wire sizes 16 to 24 AWG cannot be properly inserted without the insertion tool. Properly installed auxiliary contact of all wire gauges cannot be removed from the housing without the extraction tool.

All Data Subject to Change Without Notice 2024-0023 DS-SBEX160-175 REV 8 **Your Best Connection™**

Anderson™ will use reasonable efforts to include accurate and up-to-date content in the data sheet. All product information contained in the data sheet including ordering information, illustrations, specifications, and dimensions, are believed to be reliable as of the date of publishing, but is subject to change without notice. Anderson™ makes no warranty or representation as to its accuracy. Content in the data sheet may contain technical inaccuracies, typographical errors and may be changed or updated without notice. Anderson™ may also make improvements and/or changes to the products and/or to the programs described in the content at any time without notice. Current sales drawings and specifications are available upon request.

©2024 Anderson Power Products, Inc. All rights reserved. A®, Anderson Power Products®, SBE®, SBO®, SBS®, SBX®, PowerMod® and Powerpole® are registered trademarks of Anderson Power Products, Inc. Anderson™, Anderson Power™, Anderson Power™ logo and Your Best Connection™ are trademarks of Anderson Power Products, Inc.



HEADQUARTERS: Anderson Power Products®, 13 Pratts Junction Road, Sterling, MA 01564-2305 USA T: +1 978-422-3800 F: +1 978-422-0128 • **EUROPE:** Anderson Power Products® Ltd., Unit 3, Europa Court, Europa Boulevard, Westbrook, Warrington, Cheshire, WA5 7TN United Kingdom T: +44 (0) 1925 428390 F: +44 (0) 1925 520203 • **GERMANY:** IDEAL® Industries Germany GmbH, Esslinger Strasse 7, D – 70771 Leinfelden-Echterdingen, T: +49 (0) 711 – 997606666 • **ASIA / PACIFIC:** IDEAL® Anderson Asia Pacific Ltd., Unit 922-928 Topsail Plaza, 11 On Sum Street, Shatin N.T., Hong Kong T: +(852) 2636 0836 F: +(852) 2635 9036 • **INDIA:** IDEAL® INDUSTRIES India Private Limited, 229-230, SPAZEDGE, Tower B, Sector 47, Sohna Road, Gurgaon – 122018, Haryana, India T: +(91) 956-0075905 T: +(91) 124-4495101 • **CHINA:** IDEAL® Anderson Technologies (Shenzhen) Ltd., Block A8 Tantou Western Industrial Park, Songgang Baoan District, Shenzhen, PR. China 518105 T: +(86) 755 2768 2118 F: +(86) 755 2768 2218 • www.ideal-industries.in • www.andersonpower.com

Mouser Electronics

Authorized Distributor

Click to View Pricing, Inventory, Delivery & Lifecycle Information:

[Anderson Power Products:](#)

[441G1](#) [441G2](#) [441G3](#) [444g1](#) [6384G1](#) [6384G1-BK](#) [6384G2](#) [2-7251G1](#) [2-7251G2](#) [2-7251G3](#) [2-7251G4](#) [2-7251G5](#) [2-7251G7](#) [2-8170G1](#) [2-8170G14](#) [2-8170G2](#) [2-8170G3](#) [2-8170G4](#) [2-8170G5](#) [2-8170G7](#) [6344](#) [6380G1](#) [6381G1](#) [6383G1](#) [6385G1](#) [6390G1](#) [945G2](#) [E6375G1](#) [E6380G1](#) [E6381G1](#) [E6382G1](#) [E6383G1](#) [E6385G1](#) [E6390G1](#) [E6392G1](#) [6384G2-BK](#) [E6371G1](#)