

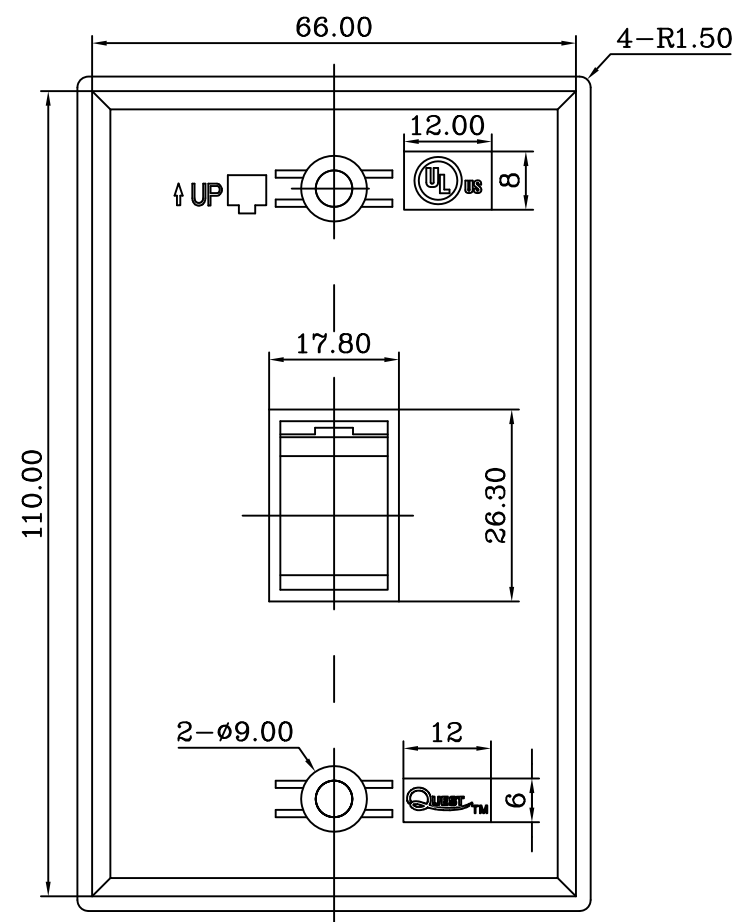

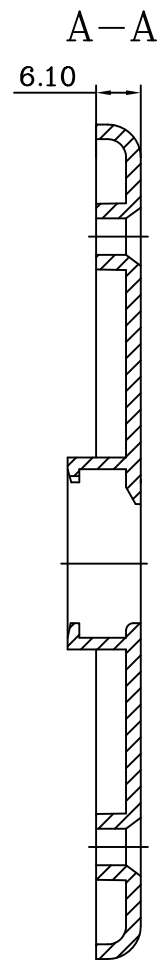

REVISIONS				
ZONE	REV	DESCRIPTION	DATE	APPROVED

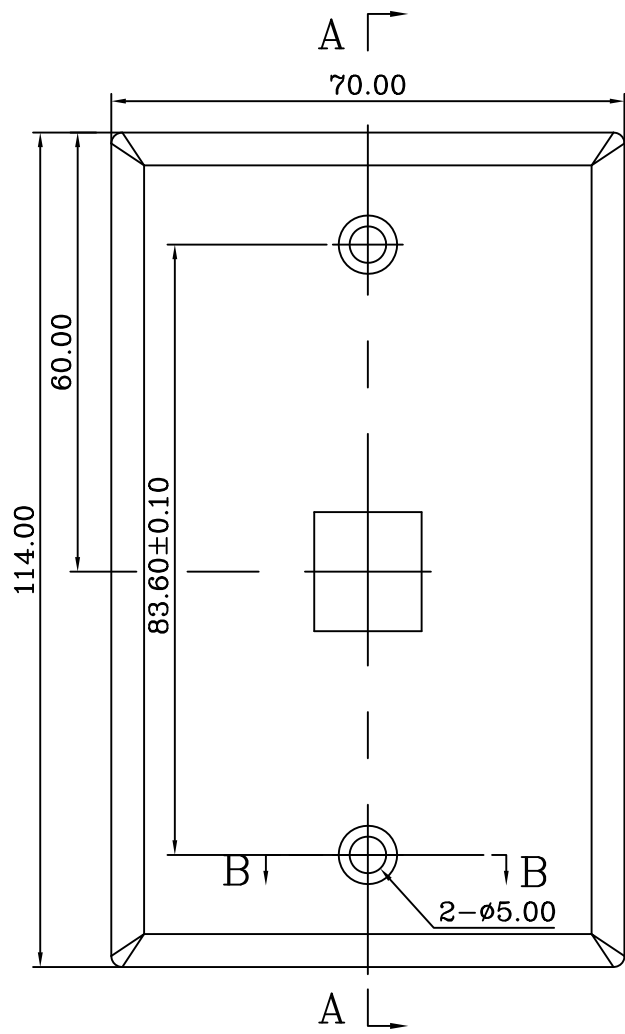

ENCLOSURE: K4.6 x 25mm SCREW X 2 
 screw head color matches wall plate color

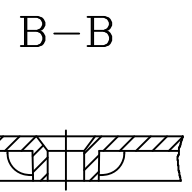

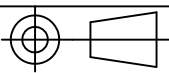
Scale	1:1	 Quest Technology Int'l, Inc 11200NW 138th st, Medley, FL33178				
3rd Angle Projection						
Unit	mm	Part no. NFP-101X				
Date	2011.12.14	Title: KEYSTONE WALL PLATE, -1				
Tolerance		Drawn by				
~20	~50	~150	150~	ALGLE	Checked by	Drawing No.
±0.2	±0.4	±0.5	±1.5	2°	黃体味	

NFP-1017	Ivory
NFP-1018	White